

PATTON

Network Access & Connectivity

PRODUCT LINE CATALOG



**Telecom, Networking & Communications Products
For Extending, Converting and Converging Networks**

www.patton.com

Catalog #21

NETWORK ACCESS

- VoIP Telephony
- IP WAN Routers
- Wide-Area Ethernet Extension
- DSL Products
- DSLAMs
- DSL CPE
- Network Termination
- Multi-Service
- Remote Access
- Cross Connects (DSL Aggregators)
- Universal Rack Systems

CONNECTIVITY

- Baluns
- Datacom Accessories
- Ethernet Extenders
- Fiber Modems
- Industrial Computers
- Interface Converters
- Line Drivers
- Multiplexers
- Opto Isolators
- Serial Device Servers
- Short Range Modems
- Surge Protectors

PATTON
Electronics Co.

PHONE: 301.975.1000

FAX: 301.869.9293

E-MAIL: sales@patton.com

WEB: www.patton.com

Welcome to Patton's Network Access & Connectivity Catalog

Welcome to Patton's Network Access & Connectivity Catalog, which coincides with our company's 23rd birthday. And this year is a coming-of-age for Patton. We have established the foundation for our transition into a multi-national company with extensive globalization initiatives. At the core of it all is the emergence of thrilling NEW technology, solutions and services, essential for Carrier, Enterprise, and Industry in today's fast-moving and converged networking and telecom markets.

—The Management Team of Patton

Bob Patton, CEO (x113) • Bobby Patton, President (x128) • Burt Patton, Executive VP (x127) • Bruce Patton, VP of Finance and Administration (x106) • Andreas Danuser, Chairman & CEO of Patton-Inalp (x106) (not shown) • Bryan E. DuBois, VP of Product Development (x132) • Steve Schrader, VP of Manufacturing (x149) • Craig Silver, Corporate Counsel (x176) • Scott Whittle, VP of Product Management (x166) • Kurt Quasebarth, Director of Materials (x154) • Chris Christner, Director of Marketing Communications (x109) (not shown)



What's Hot

CopperLink *Going the Distance*

Ethernet Extension — CopperLink Extenders are going-the-distance and turning standard LAN ports into Wide Area Ethernet by extending Ethernet ports over copper.



IPLink *Link Up for Less*

WAN Gateway Routers — IPLink Router series lets users link-up-for-less to any broadband service with affordable WAN Routers with VPN, security and integrated T1, DSL or serial interfaces.



ForeFront *Leading the Edge*

Multi-Service Access — ForeFront is leading-the-edge with low cost, flexible, broadband switch/router access products for IP, VLAN, and TDM transport and aggregation.



SmartNode *More Than Just Talk*

Telephony & VoIP Solutions — SmartNode VoIP is a line of integrated voice/data routers with a wide range of port densities, interface options and software configurations enabling VoIP deployments in all networking environments.





Next Generation Technical Services

A World of Problem Solving

Need help with your network? Patton's expanding services organization provides system engineering, installation, operations, and maintenance for voice, data, and integrated networks. As an "integrator's integrator," Patton's new Global Solutions Group is able to build multi-vendor systems for carriers, ISPs and corporate enterprises anywhere in the world using an extensive network of local personnel and integration contractors.

EtherBITS *Connect With Confidence*

EtherBITS Device Servers — Leverage the power and flexibility of Ethernet and Wireless Ethernet to control, monitor, and collect data from all your serial devices.



RedRAS *More Dial-Up ...Less Dollars*

RAS/Dial-up Networking — Everything you need for any kind of dial-up network access, all in one box. Legacy modems, V.92, ISDN, and much more.



Summary Table of Contents

Network Access

VoIP Telephony	• 10
IP WAN Routers	• 40
Wide-Area Ethernet Extension	• 56
DSL Products	• 66
DSLAMs	• 80
DSL CPE	• 84
Network Termination	• 98
Multi-Service (ForeFront)	• 112
Remote Access	• 114
Cross Connects (DSL Aggregators)	• 125
Universal Rack System	• 134

Connectivity

Industrial Computers	• 146
Serial Device Servers	• 148
Interface Converters	• 170
Opto Isolators	• 182
Baluns	• 188
Line Drivers	• 200
Short Range Modems	• 200
Fiber Modems	• 216
Multiplexers	• 218
Datacom Accessories	• 226
Surge Protectors	• 230

Patton Highlights

Doing Business with Patton is Easy

Money-Back Guarantee

Buying from Patton means that you may return any standard Patton product within 30 days. So, you can purchase with complete confidence.

Free Top-Notch Technical Support...Forever

Buying from Patton means that you can speak directly with skilled support technicians who know the products best; so your problem will be addressed quickly and efficiently.

Equipment Financing

Buying from Patton means you can finance the purchase of any Patton product over 24 to 36 months.

Easy Ordering & Quick Delivery

Buying from Patton means you can place your order by phone, email, fax, or regular mail. Shipments from stock are made within *one day* of ordering, and we can ship FedEx or UPS overnight.

Everything Online

Buying from Patton means that you can take full advantage of our website (www.patton.com). You can access user manuals, technical notes, software upgrades, datasheets, and news releases.

What's HOT at Patton

www.patton.com

SmartNode VoIP

More Than Just Talk

SmartNode VoIP is More Than Just Talk, it's a full range of integrated voice/data routers with a wide range of port densities, interface options and software configurations enabling VoIP deployments in any network environment.

- Seamless Converged Communications.
- An exhaustive range of VoIP products developed over 9 years.
- Robust software designed to fit even the most unique VoIP deployment scenarios.
- A strong following of satisfied Carrier and Enterprise customers.

Each product in the extensive range providing full voice compression and packetization using all the industry standard Codecs and H.323, SIP and MGCP protocols. The product line has been continually developed over 9 years, representing the most comprehensive line of VoIP products in the industry.



IPLink WAN ROUTERS

Link Up for Less

IPLink Router series lets users Link Up for Less to any broadband service with affordable WAN Routers offering VPN, security, and integrated T1/E1, DSL or Sync-Serial interfaces.

- The lowest cost T1/E1 Broadband Routers on the market.
- Reduces Internet access and broadband branch office connectivity costs from day one.
- Realizes Carrier Profitability.



DialFire RAS

More Dial-Up, Less Dollars

Remote Access Servers provide More Dial-Up for Less Dollars by providing everything you need for any kind of dial-up network access; all in one box. Patton's RedRAS and DialFire RAS solutions supports legacy modem compatibility, V.92, ISDN and an unsurpassed set of RAS, authentication, routing and access features.

- Dial-up for ISP Internet Access.
- Dial-up for Corporate and Secure VPN Access.
- Dial-up for Remote Industrial Communications.
- Dial-up for Point of Sale and Banking.
- Dial-up for any Machine-to-Machine Communications



ForeFront ACCESS

Leading The Edge

ForeFront is **Leading The Edge** with low-cost, flexible, broadband switch/router multi-service access products for ADSL2+, G.SHDSL, IP, VLAN, VPN, and TDM transport and aggregation.

- The only access services delivery platform with integrated TDM and IP switch-router features.
- TriplePlay convergence by providing multiple managed services to the subscriber over a single link.

- Broadband/DSL Transport and Aggregation over both SDH/SONNET and Gigabit Ethernet.
- Fully redundant TDM and Packet Busses with embedded fail-safe processors on each card.
- Management system options for small, medium, and large scale deployments.
- A wide range of Access Line Cards from Dial-Up, ADSL2+, G.SHDSL, T1/E1 and Ethernet.
- Compact design with a low price-per-port.



EtherBITS DEVICE NETWORKING

Connect With Confidence

EtherBITS enables users to **Connect With Confidence** by taking advantage of the versatility and reliability of Ethernet.

Device Servers

- Control, Collect, and Monitor data from virtually any serial device over any IP network.
- Provide a secure encrypted connection between your serial devices and IP network.



CopperLink LAN EXTENSION

Going The Distance

Ethernet Extenders are **Going The Distance**, turning standard LAN ports into Wide Area Ethernet by extending Ethernet ports over copper.

Patton is the premier manufacturer and supplier of devices for Extending Ethernet in the world. Our comprehensive line of products enables Ethernet extensions at a variety of speeds and distances.

- Allows Ethernet to operate over existing standard phone grade twisted pair
- Extends Ethernet up to 5 miles (8 km)
- Line rates range from 144 kbps to 50 Mbps symmetrical!



Network Access

VoIP Telephony

10-39

Residential ATAs	16	IpChannel Bank Multi-Port FXS & FXO Gateway Router	29
Micro-Analog Telephone Adapter	16	Modular VoIP Routers & Interface Cards	30
Micro-Analog Fax Adapter	16	4-Slot Modular Router	30
Smart-ATA Analog Telephone Adapter	17	30-Channel E1 Module for ISDN PRI	31
Smart VoIP Analog WiFi Telephone Adapter	18	23-Channel T1 Module for ISDN PRI	31
Smart-DTA Digital Telephone Adapter	19	8-Channel Module Provides 4 ISDN BRI Interfaces ..	31
Business Class VoIP Gateways	20	4-Channel Module Provides 4 Analog Phone Ports ..	31
Analog VoIP SoHo Router	20	IP-PBXs	32
Multi-Port FXS/FXO VoIP Gateway Series	21	IP-PBX	32
Business Class VoIP Routers	22	Enterprise Class IP-PBX	35
Small & Branch Office ISDN VoIP Routers	22	SIP Telephones	34
ISDN BRI PSTN Gateway	23	SIP Telephones	34
Multi-Port FXS/FXO VoIP Gateway Router	24	Specialized VoIP Products	36
Multi-Port ISDN VoIP IAD	25	VoIP Auto-Provisioning System (VAPS)	36
FXS/FXO VoIP IAD with WAN Access	26	VoIP Bundles	36
Multi-Port ISDN VoIP IAD with Integrated WAN Access	27		
Multi-Port T1/E1 VoIP Integrated Access Device ..	28		

WAN Routers

40-55

Low-Cost WAN Routers	46	Integrated TDM & IP Router	52
Ethernet Managed VPN WAN Router	46	Channelized Gigabit Router	53
DMZ Secure Router	47	Edge Routers	54
Low-Cost T1/E1 WAN Access Router	48	Multi-Megabit Inverse Mux	54
Managed VPN Routers	49	Modular T1/E1 Routers	55
Sync. Serial WAN Routers	50		
T1/E1 Managed VPN WAN Router	50		
Sync. Serial Managed VPN WAN Router	51		

Wide-Area Ethernet

56-65

Copper Ethernet Extenders	57	IP Network Camera Extender	62
50 Mbps Multi-Rate Ethernet Extender	57	CopperLink™-T Extender	63
16.67 Mbps Multi-Rate Ethernet Extender	58	Bridges	64
12.5 Mbps CopperLink™ Ethernet Extender	59	Compact Ethernet-over-E1 WAN Bridge	64
2.3 & 4.6 Mbps Ethernet Extenders with Auto-Rate Adaptation	60	Ethernet MicroBridges (X.21, RS-232, RS-530, & V.35)	65
144 kbps LAN Extender	61		

COOL PRODUCTS

See page 62

Transport and extend T1 or E1 lines



See page 29

Bulk analog VoIP termination — IpChannel Bank



HOT PRODUCTS

Balun — E1 coax to copper conversion

See page 190



See page 150

Industrial control over Ethernet



See page 97

Extend async RS-232 up to 5 miles (8 km) using DSL friendly technology



Table of Contents

Network Access

Transmission

66-97

DSL Solutions	68	G.SHDSL CPE	84	2B1Q Encoding, 2 or 4-Wire	
Integrated DSL Access Infrastructure	70	Low-Cost, High-Speed G.SHDSL Modem	84	Baseband Modem	95
ForeFront Solutions for DSL	71	G.SHDSL FRF.5/FRF.8 over ATM NTU	85	IDSL Modems with V.35, X.21, or	
ForeSight™ NMS	72	G.SHDSL Integrated Access Device	86	10Base-T (Ethernet) Interfaces	96
G.SHDSL Line Card	74	ipRocketLink™ Serial G.SHDSL	87	High-Speed Serial Extender & RS-232	
IDSL Line Card	75	G.SHDSL FRF.5/FRF.8 over ATM IAD	88	Serial Extender	97
ADSL2+ Triple-Play Access Line Card	76	G.SHDSL High-Speed Router	89		
Router Line Card	77	G.SHDSL.bis Business Router	90		
Matrix Switch Line Card	78	VDSL CPE	91		
ipDSLAMs	80	VDSL Data & Voice Modems	91		
High-Speed G.SHDSL Concentrator for		Variable-Rate VDSL Modems	92		
IP Traffic	80	IDSL CPE	94		
VDSL Access Concentrator/Switch	82	IDSL DACS Provides Quad T1/E1 &			
		24 IDSL Ports	94		

Network Termination

98-111

T1 Network Access	100	E1/G.703 Access Converters	104	64-K G.703 Access Converters	108
Compact T1/FT1 CSU/DSU	100	MicroLink™ CSU/DSU	104	Lowest Cost G.703 NTU	108
T1/FT1 to V.35 Converter & CSU/DSU	102	G.703/G.704 NTU	104	MicroLink-E1™ E1/FE1 Nx64 CSU/DSU	109
T1/FT1 High-Density, CSU/DSU Rack Card	103	MicroPak™ G.703 Interface Converter	106	Co-directional G.703 Converters	110
		MegaLink-IT™ 2 Mbps G.703 Access Converter	107	G.703/64-kbps Interface Converter	111

Multi-Service Access

112-137

Carrier Class RAS	114	Micro RAS	123	Universal Access Rack	134
ForeFront RAS 2U, 4U, & 6U Chassis Systems	114	Micro Serial RAS	123	1001 Rack System, High Density,	
ISP RAS	116	Multi-Service Cross Connect (DACs)	125	2U High, 16 slot	134
16, 24, 30, 48 or 60-Port RedRAS	116	ForeFront Multi-Port DACS	125		
96 or 120-Port RedRAS	118	Digital Cross Connects	126		
96 or 120-Port Dial-up RedRAS	120	4 & 8-Port DACS	128		
Enterprise RAS	122	Low-Cost Managed DACS	130		
Server-Based Remote Access	122	16-Port DACS	132		

Table of Contents

Connectivity

Industrial Ethernet

142-155

EnviroNET™ Solutions 144

Nano Industrial Computers 146

NanoServ™ Industrial PC146

Device Servers 148

Single-Port Terminal Server148
RS-232 Device Server149
RS-485/422/232 Universal Device Server150

Wireless (802.11b) Device Server151
Multi-Port Asynchronous RS-232 Device Servers152
Async. over IP Multi-Port Device Servers153
Leased-Line Extender over IP154
Bluetooth IP Access Point155

Interface & Media Converters

170-187

Wide Area Network Converters 170

RS-232 Async. to Sync. Converters172
Passive RS-530 to V.35 Converter172
Passive RS-449 to V.35 Converter173
Mini X.21 to V.35 Converter173
RS-232/V.35 to X.21 Converter Rack Cards173
Passive RS-232 to V.35 Converters174
RS-232 to V.35 Converter Rack Card174
RS-232 to X.21 Interface Converter175
RS-232 to V.36 (RS-550/449) Interface Converter175
Micro V.35 to T1 Converter176
Micro V.35 to G.703/G.704 (E1) Converter176
V.35 to HSSI Converter177

X.21 to HSSI Converter177
RS-422/530 to HSSI Converter177

Async./Industrial Converters 178

Interface Powered, RS-232 to RS-485 Interface Converters (with Handshaking)178
Interface Powered, RS-232 to RS-422 Interface Converters (Transmit & Receive Data Only)180
RS-232 to Current Loop Converters (20 or 60mA)182
RS-232 to 20mA Current Loop Converter (DB-25 to DB-25)182
Ethernet to RS-232 Converter/Terminal Server183

Ethernet Micro Bridges 183

Ethernet to V.35 Converter/Bridge183
Ethernet to X.21 Converter/Bridge184
Ethernet to V.24 Converter/Bridge184
Ethernet to EIA-530 Converter/Bridge184
Auto-Directional Serial to Parallel Converters185
Compact Interface Serial to Parallel Converters185

Printer Interface Converters/Extenders 186

Powered Serial to Parallel Printer Converter186
RS-232/423 to IEEE-1284 Converter186
Self-Powered Parallel Line Extenders187
AC Powered, Parallel Short Range Modem187

Baluns

188-199

G.703 Baluns 190

Single-Port E1/E2 IDC Krone Baluns190
G.703 Balun (E1), 2 Mbps with Built-in Cables (75 to 120-ohm)192
G.703 (E1, E2, E3) Baluns (75 to 120-ohm)192
G.703 (E1) Balun, 2 Mbps (1.6/5.6 Connectors)193

155-Mbps ATM Baluns Swap Coax for Twisted Pair193
G.703 (E1) Balun Panels (75 to 120-ohm)194
Ultra High Density G.703 (E1) Balun Panel195
High Density E1/G.703 Balun Panels196

Legacy Baluns (IBM 3270, AS400) 197

IBM 3270 Coax to Twisted-Pair Baluns197

Twinax to Twisted-Pair Adapter (Balun)197

Video Baluns 198

CCTV Passive Baluns198
CCTV Passive Pass-Thru Baluns198
CATV Passive Baluns199
Component Video Balun199

Line Drivers & Modem Eliminators

200-217

Self-Powered Line Drivers 202

High-Speed Serial Extender & RS-232 Serial Extender202
USB 1.1 Extender Kit202
SRM, Async Point-to-Point, 19.2 kbps203
SRM, Transformer Isolated, 4 Wire to RS-232203
SRM, Full-Duplex, 2 Wire to RS-232, 19.2 kbps204
SRM, Full-Duplex, Carrier Sense, 19.2 kbps, 2 Wire204
SRM, Multipoint, 2/4 Wire, 115.2 kbps205
SRM, Multipoint, 2/4 Wire, 115.2 kbps, Rack Card205
SRM, Async, 38.4 kbps206
SRM, Async, 38.4 kbps, Rack Card206

SRM, Sync/Async, 38.4 kbps206
SRM, Sync Point-to-Point, 19.2 kbps207
SRM, Sync, 64 kbps208
Line Extenders208
SRM, Sync/Async, RS-232 & RS-530, 64 kbps209
SRM, Sync/Async, RS-232 & RS-530, 64 kbps, Rack Card209
SRM, Async with Extra Controls, 57.6 kbps209

Powered Line Drivers 210

SRM, Async, 38.4 kbps210
SRM, Async, 115.2 kbps210
SRM, Sync, Opto-Isolated, RS-232, 19.2 kbps211

SRM, Sync, Opto-Isolated, RS-232, 19.2 kbps, Rack Card211
SRM, Sync, Opto-Isolated, X.21, 64 kbps211
SRM, Sync/Async, 2/4 Wire, Half/Full Duplex212
SRM, Sync/Async, 2/4 Wire, Half/Full Duplex, Rack Card212
SRM, Baseband, Ruggedized for Outdoor Use, 64 kbps213

Modem Eliminators 214

Sync, 38.4 kbps, Self Powered214
Sync, 224 kbps, Self Powered214

Table of Contents

Connectivity

Line Drivers & Modem Eliminators (Continued)

200-217

Sync, 512 kbps, Self Powered	214	Fiber Modems	216	RS-232, Async or Sync, 38.4 kbps, Rack Card . . .	216
V.35 or X.21, Sync, 144 kbps	215	RS-232, Async, 19.2 kbps	216	Wireless Short Range Modems	217
V.35 or X.21, Sync, 144 kbps, Rack Card	215	RS-232, Async, 19.2 kbps, Rack Card	216	RS-232 Bluetooth Wireless Modem 2-Packs	217
Anti-Streaming Device	215	RS-233, Async or Sync, 38.4 kbps	216		

Multiplexers & Sharing Devices

218-229

Multiplexers	219	Modem/Port Sharing Devices	223	Mini-Rack System & ClusterBoxes	226
Multiport Async. Multiplexer	219	Digital Sharing Device (DSD), V.24, 6 Ports		Rack Chassis, 2U, 16-Slot	226
Low-Speed Time-Division Multiplexer	220	DCE to 1 DTE	223	Cluster Chassis, 2U, 2-Slot	226
Miniature 2-Port Statistical Multiplexer	220	Powered RS-232 Modem Sharing Devices	224	Cluster Chassis, 2U, 4-Slot	226
Powered 8-Channel, Async/Sync		Modem Sharing Device	225	Cluster Chassis, 2U, 8-Slot	226
Statistical Multiplexers	221	Micro Modem Splitter	225	Universal Mounting Panel, 2-Slot	228
4, 6 & 8 Channel Limited Distance Multiplexers	222			Universal Mounting Panel, 10-Slot	228
				Universal Mounting Panel, 16-Slot	229

Surge Protectors

230-239

Async DB-25 Surge Protectors	232	Parallel Surge Protectors	233	Twinax Surge Protectors for IBM AS/400	236
Async DB-25 Low Capacitance Surge Protector	232	10/100Base-T (Cat-5) Secondary		Video Surge Protectors	236
Sync DB-25 Surge Protector	232	Surge Protector	234	Async RS-232-to-RS-232 Optical Isolators	237
Sync DB-9 Surge Protector	232	10/100Base-T (Cat-5) Secondary		Async RS-422/485 Optical Isolators	237
Sync DB-15 Surge Protector	232	Multiprot Protectors	234	V.35 (M/34) Surge Protector	237
Serial DB-25 Surge Protector (All 25 Leads)	232	Multiprot RS-232 & RS-422 Surge Protectors	235	Telco Surge Protectors	238
RJ-11 Surge Protector	233	Coax Ethernet Surge Protectors	235	Terminal Strip Surge Protector	239
RJ-12 Surge Protector	233	Ethernet AUI Surge Protector (DB-15)	236		
RJ-45 Surge Protectors	233	802.5 Token Ring Surge Protectors	236		

Testers & Widgets

240-244

DB-25 & DB-9 Data Taps	240	Loopback Adapter	241	Cable Adapters (Solder Type or Solderless)	243
DB-9 Data Tap, Half Duplex	240	Async Null Modem Adapters	241	DB-25 Micro Breakout Box	243
Telco Data Taps for T1, E1 or DDS	240	DB-25 to Modular Adapter	242	DB-25 to Terminal Block Adapter	243
M/34 (V.35) Data Tap	240	HD-15 to Modular Adapter	242	DB-25 Gender Changer	244
DB-25 & DB-9 Power Supply Adapters	240	DB-9 & DB-15 Modular Adapters	242	DB-9 & DB-15 Gender Changers	244
Modular to Modular Adapters	241	DB-25 PockeTester	242	DB-25 Cube Tap	244
RS-232 Interface connectors	241	PocketBOB DB-25 Breakout Box	242	DB-9 to DB-25 Adapters	244
Pin 2-3 Reverser	241	DB-9 PockeTester	242		

Technical Reference

245-250









Index

251-272

SmartNode & SmartLink Voice over IP





Product Line Summary

Product Line	Series	Description	Pg	
Residential 	M-ATA	Micro-Analog Telephone Adapter	16	
	M-AFA	Micro-Analog Fax Adapter	16	
	S-ATA	Residential Smart Analog Telephone Adapter	17	
	S-DTA	Residential Smart Digital BRI Telephone Adapter	19	
	S-WTA	Residential Smart Wireless Analog VoIP IAD	18	
Branch Office SOHO 	SN411X	Multi-Port Analog VoIP Gateway	21	
	SL402X	Analog VoIP SoHo Router	20	
	SN455X	ISDN BRI VoIP SoHo Router	21	
Enterprise 	Large Enterprises Medium Enterprises Carrier	SN452X	Multi-Port Analog VoIP IAD	22
		SN483X	Multi-Port Analog IAD with Integrated WAN Access	26
		SN463X	Multi-Port ISDN VoIP IAD	25
		SN465X	Multi-Port ISDN VoIP IAD with Integrated WAN Access	27
		SN4960	Multi-Port T1/E1 VoIP IAD	28
Carrier 	SN4900	IpChannel Bank	29	
	SN2400	4-Slot Modular VoIP Routers	30	

								
Model	M-ATA, M-AFA	S-ATA	S-DTA	S-WTA	SL402X	SN411X	SN455X	SN452X
Description	Micro-Analog Telephone Adapter & Micro-Analog Fax Adapter	Smart Analog Telephone Adapter	Smart Digital (BRI) Telephone Adapter	Smart Wireless Analog VoIP IAD	Analog VoIP SOHO Router	Multi-Port Analog Gateway	ISDN BRI VoIP SOHO Router	Multi-Port Analog VoIP Router
VoIP Call Capacity	2	4	2	2	4	up to 8	2 / 4	up to 8
Ethernet Ports	1	2	1	5	2	2	5	2
Voice Interfaces	1	1 or 2	1	2	1	up to 8	2	up to 8
WAN Data Interfaces	-	-	-	-	-	-	-	-
Expansion Modules/Slots	-	-	-	-	-	-	-	-
Call Control CODECs/Fax	SIP G.711, G.729, G.726, G.723.1 T.38 & G.711 Fax bypass	SIP G.711, G.729ab, G.726, G.723.1, T.38	SIP & H.323	SIP	SIP or MGCP G.711, G.729, G.726, G.723.1, T.38 & G.711 Fax bypass	SIP, H.323, and MGCP G.711, G.723.1, G.729, G.729a, G.729b, G.729ab, G.727, G.726, T.38 with G3 Fax Relay; G.711 Fax Bypass		
Quality of Service	VLAN tagging and queuing, TOS and DiffServ labeling	TOS and DiffServ labeling	VLAN tagging and queuing, TOS and DiffServ labeling	TOS and DiffServ labeling	VLAN tagging and queuing, TOS and DiffServ labeling	TOS and DiffServ labeling	Same as SN483X	
IP Connectivity Features/VPN	DHCP client, DynDNS client, DNS SRV, VLAN, SNMP, SNTP, WWW, PPPoE, STUN, Syslog	IP Router, NAT/NAPT, DHCP server/client	IP Router, NAT/NAPT, DHCP client, DynDNS client, VLAN, SNTP, PPPoE	IP Router, NAT/NAPT, DHCP server/client	NAT, NAPT, DHCP client/ server, DynDNS client, DNS SRV, VLAN, SNMP, SNTP, PPPoE, STUN, SYSLOG	NAT/NAPT; DHCP server/client; DNS Relay; DynDNS client; SIP DNS SRV; VLAN .p/Q; SNMP, SNTP, WWW GUI, RIPv1/v2, PPPoE		

More Than Just Talk

Enterprise Telephony Products

Product Line	Series	Description	Pg
 	SL4050/2	IP Phone with 2 lines	34
	SL4050/10	IP Phone with 10 lines	34
 	SIPxNano-15	Small Office IP-PBX for up to 15 extensions	32
	SIPxNano-30	Small Office IP-PBX for up to 30 extensions	32
	SL4250-75	Medium Office IP-PBX for up to 75 extensions	35
	SL4250-125	Medium Office IP-PBX for up to 125 extensions	35
	SL4250-250	Medium Office IP-PBX for up to 250 extensions	35

In This Section

Residential VoIP

- Micro-Analog Telephone Adapter • 16
- Micro-Analog Fax Adapter • 16
- Smart Analog Telephone Adapter • 17
- Smart Analog Wireless Telephone Adapter • 18
- Smart Digital Telephone Adapter • 19

Branch Office VoIP/SoHo





- Multi-Port Analog VoIP Gateway • 21
- Analog VoIP SoHo Router • 20
- ISDN BRI VoIP SoHo Router • 23

Enterprise VoIP

- Multi-Port PRI T1/E1 VoIP IAD • 28
- Multi-Port Analog VoIP IAD • 24
- Multi-Port Analog IAD with Integrated WAN Access • 26
- Multi-Port ISDN VoIP IAD • 25
- Multi-Port ISDN VoIP IAD with Integrated WAN Access • 27

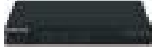
Carrier VoIP

- ISDN BRI VoIP Gateways • 23
- Modular VoIP Routers • 30
- IP Channel Bank • 29
- SIP Telephones & IP-PBX • 34

						
Model	SN483X	SN463X	SN465X	SN4960	SN4900	SN2400
Description	Integrated WAN Access VoIP Router	Multi-Port ISDN VoIP IAD	Multi-Port ISDN VoIP IAD with Integrated WAN Access	Multiport T1/E1 VoIP IAD	IP Channel Bank	4-Slot Modular VoIP Gateway
VoIP Call Capacity	up to 8	4 / 8	4 / 8	up to 120	up to 32	up to 120
Ethernet Ports	2	2	2	2	2	2
Voice Interfaces	up to 8	3 / 5	3 / 5	4	up to 32	up to 16
WAN Data Interfaces	V.35, X.21, T1/E1, ADSL, G.SHDSL	-	V.35, X.21, T1/E1, ADSL, G.SHDSL	V.35, X.21, T1/E1, ADSL, G.SHDSL	V.35, X.21, T1/E1, ADSL, G.SHDSL	-
Expansion Modules/Slots	-	-	-	-	-	4-for BRI, PRI, T1/E1, or FXS
Call Control CODECs/Fax	SIP & H.323 G.711, G.723.1, G.729, G.729, G.729a, G.729b, G.729ab, G.727, G.726 T.38 with G3 Fax Relay; G.711 Fax Bypass					
Quality of Service	TOS and DiffServ labeling; Active QoS with traffic scheduling and classification. Weighted fair queuing and shaping of traffic classes with configurable tolerance; DownStreamQoS™ with dynamic restriction of inbound TCP traffic.					
IP Connectivity Features/VPN	NAT/NAPT; DHCP server/client; DNS Relay; DynDNS client; SIP DNS SRV; VLAN .p/Q; SNMP, SNMP, WWW GUI, RIPv1/v2, PPPoE Static Firewall ACLs; Filtering Ping DoS Detection; IPsec with DES/3DES/AES including Internet Key Exchange (IKE); VPN-Passthrough for PPTP/GRE					

SmartNode & SmartLink Voice over IP

Gateway/Router Product Finder

	Number of Telephony Ports	Max Number of Simultaneous Calls	Telephony interfaces	Gateway or Router
Analog VoIP From 1 to 32 ports for analog FXS or FXO IP connectivity 	1	2	FXS	Gateway
	1 or 2	2	FXS	Router
	2 to 8	8	FXS and FXO	Gateway
	1 or 2	4	FXS	Router
	2 to 8	8	FXS and FXO	Router
	2 to 8	8	FXS and FXO	Router
	2	2	FXS	Wireless Router
	up to 32	up to 32	FXS	Router
ISDN BRI VoIP The most comprehensive BRI VoIP solutions on the planet 	1	2	BRI So	Gateway
	2	2 / 4	BRI So	Router
	3 / 5	4 / 8	BRI So	Router
	3 / 5	4 / 8	BRI So	Router
	4 to 16	32	BRI So	Router
T1/E1/PRI PSTN Gateway VoIP Trunking High-capacity trunk solutions 	1 or 4	15 to 120 software upgradeable	T1/E1/PRI	Router
Modular - Mixed Analog and Digital Do-anything VoIP boxes 	up to 16	120	T1/E1/PRI FXS, BRI	Gateway/Router

More Than Just Talk

<i>Ethernet Ports</i>	<i>WAN Egress</i>	<i>Series</i>	<i>Series Description</i>	<i>Pg</i>
1	10/100 Ethernet	M-ATA/M-AFA	Micro-Analog Telephone Adapter & Micro-Analog Fax Adapter	16
2	10/100 Ethernet	S-ATA	Residential Smart Analog Telephone Adapter	17
1	10/100 Ethernet	SN411X	Multi-Port Analog VoIP Gateway	21
2	10/100 Ethernet	SL402X	Analog VoIP SoHo Router	20
2	10/100 Ethernet	SN452X	Multi-Port Analog VoIP IAD	24
2	Ethernet, Sync. Serial, T1/E1, G.SHDSL or ADSL	SN483X	Multi-Port Analog IAD with Integrated WAN Access	26
5	10/100 Ethernet	S-WTA	Wireless Analog VoIP IAD	18
2	Ethernet, Sync. Serial, T1/E1, G.SHDSL or ADSL	SN4900	IpChannel Bank	29
1	10/100 Ethernet	S-DTA	Residential Smart Digital Telephone Adapter	19
5	10/100 Ethernet	SN455X	ISDN BRI VoIP SoHo Router/PSTN Gateway	23
2	10/100 Ethernet	SN463X	Multi-Port ISDN VoIP IAD	18
2	Ethernet, Sync. Serial, T1/E1, G.SHDSL or ADSL	SN465X	Multi-Port ISDN VoIP IAD with Integrated WAN Access	27
2	Ethernet	SN2400	4-Slot Modular VoIP Routers	30
2	10/100/1000 Ethernet	SN4960	Multi-Port T1/E1 VoIP IAD	28
2	Ethernet	SN2400	4-Slot Modular VoIP Routers/Gateways	30

SmartNode & SmartLink Voice over IP

Solutions Center Product Guide for Service Providers

Residential VoIP Services

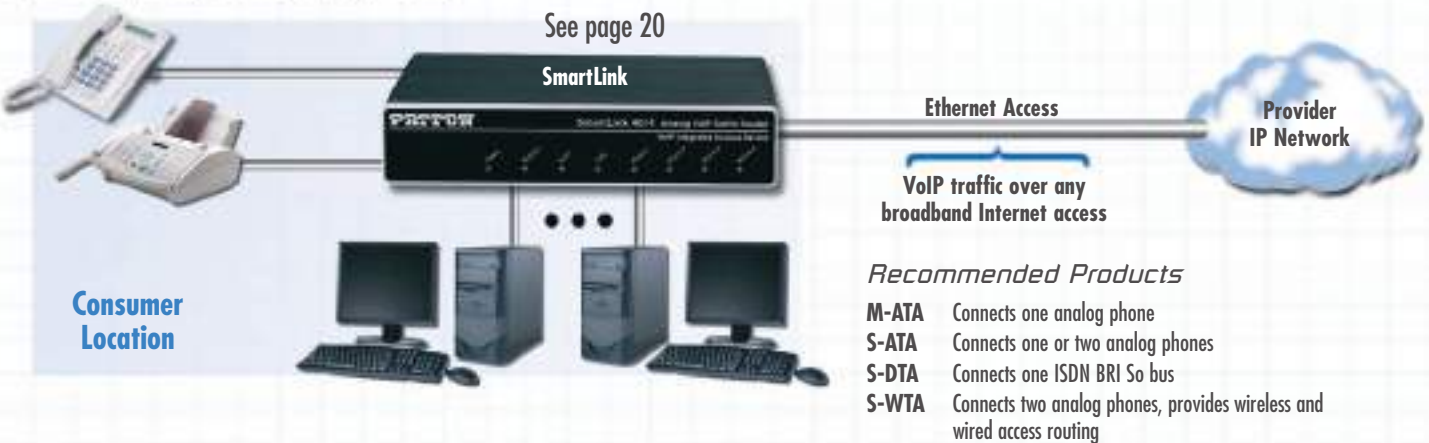

Business Trunking

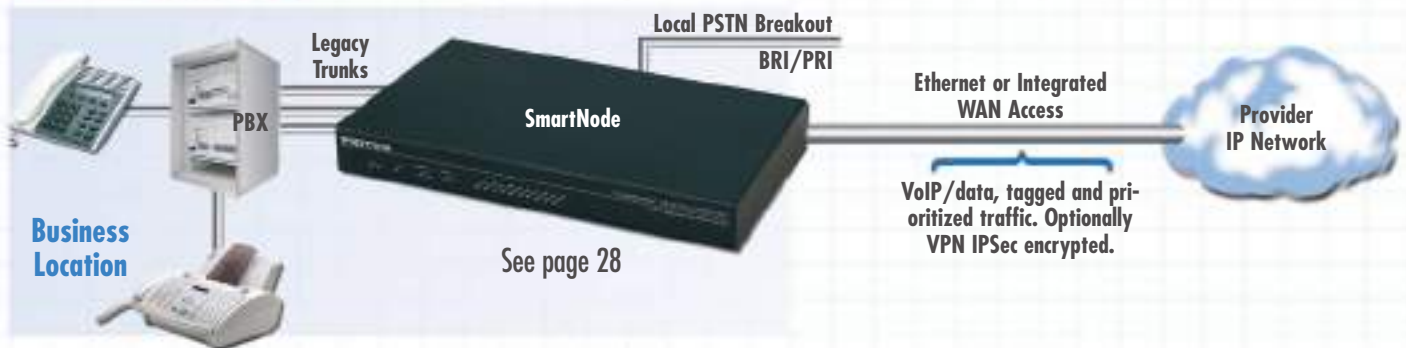

Recommended Products

SN4960 4 T1/E1/PRI ports to PBX, PSTN breakout capability, IP access routing with GigE, optional ADSL+, G.SHDSL, X.21/V.35 or T1/E1 WAN access

SN4634 3 or 5 ISDN BRI So ports, 4 or 8 low-bandwidth voice or T.38 fax calls, PSTN breakout capability, Ethernet WAN access

Hosted PBX Services with Legacy Handsets

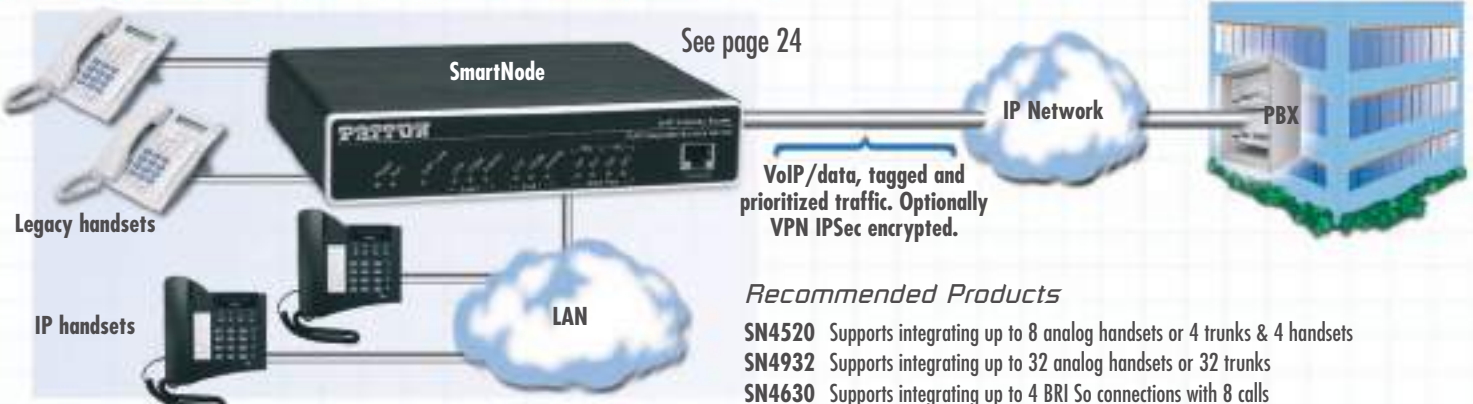

More Than Just Talk

Solutions Center Product Guide for Enterprises

Branch Office Telephony

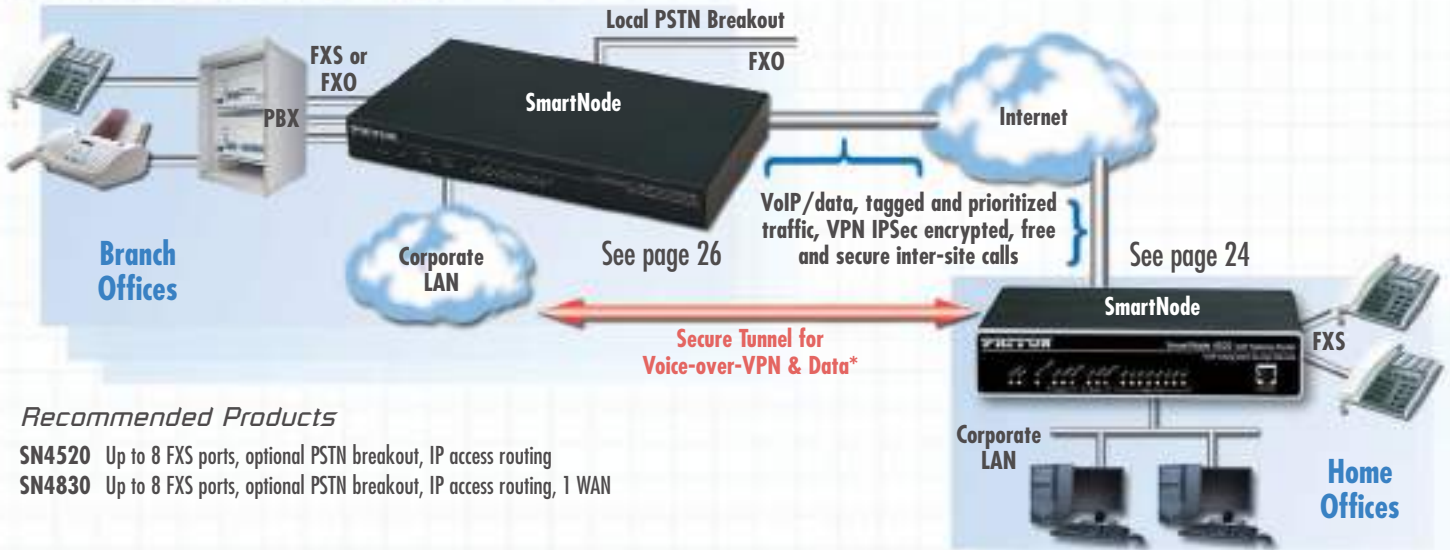

Recommended Products

- SN4520 Up to 8 FXS ports, optional PSTN breakout, IP access routing
- SN4830 Up to 8 FXS ports, optional PSTN breakout, IP access routing, 1 WAN

PBX Extension

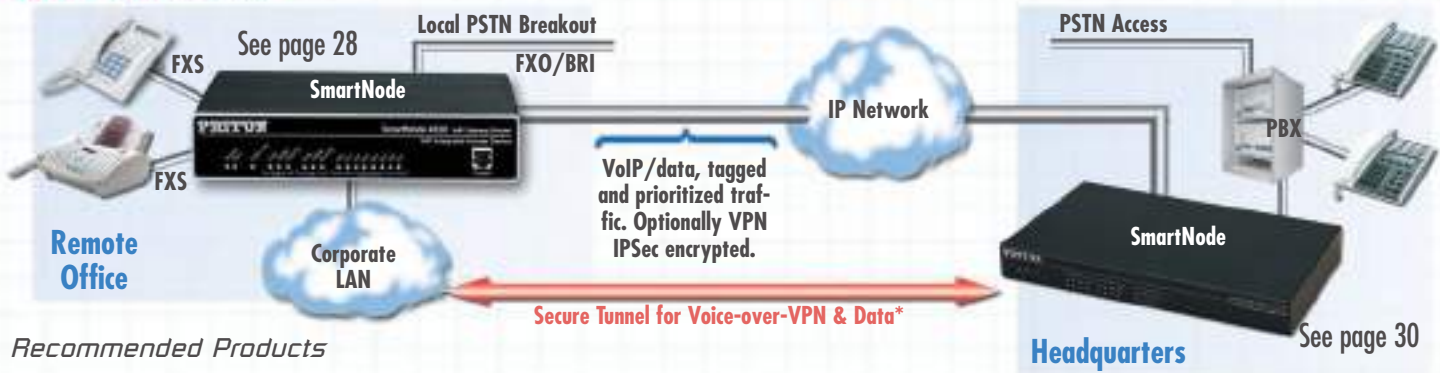

Recommended Products

- SN4960/SN2400 Headquarters, for T1/E1/PRI PBX connection
- SN4630 Headquarters, for BRI PBX connection
- SN4520 Remote office, up to 8 analog line extensions

* Optional license sold separately

Off-Site Call Center



Recommended Products

- | | |
|---------------------------------|--|
| Local Dial-in | Off-site Call Center |
| SN4960 For T1/E1/PRI VoIP | SN4960 For T1/E1/PRI call center connection |
| SN4900 For analog dial-in — FXO | SN4900 For analog call center connection — FXS |

Micro-Analog Telephone Adapter & Fax Adapter

SmartLink™ M-ATA

Quickly and easily converts any phone or fax machine to VoIP for residential and telecommuter applications.



The SmartLink Micro Analog Telephone Adapter provides connectivity for analog phones and faxes to a home, home office or corporate LAN. Connecting to any analog phone, fax or PBX, the SmartLink product is a cost effective solution for small offices and telecommuters to access Internet-based telephone services and corporate intranet systems across established LAN and Internet connections like DSL and cable modems.

The M-ATA provides one Ethernet (RJ-45) port and one FXS (RJ-11) analog phone port for quick and easy interconnection to the local LAN. LEDs show at-a-glance the status of the system, LAN, WAN, and phone ports.

A full suite of IP features (DHCP) are available to maximize universal connectivity. VLAN tagging and prioritiza-

tion enables voice traffic to be handled before data traffic, ensuring higher quality voice calls. Support for PPPoE tunneling simplifies extending corporate intranet services to telecommuters.

The user friendly web interface offers two levels of configuration: level one covers basic subscriber-specific parameters, level two offers advanced settings for the transport network. Configuration and firmware can be downloaded from a centralized TFTP or HTTP server.

The M-ATA is SIP standard compliant. Analog phones attached to the SmartLink can use advanced calling features such as call forwarding, caller ID, 3-way calling, call holding, call retrieval, and call transfer.

VoIP-enable your existing fax machines

Integrated support for T.38 brings fax machines into the low-cost world of VoIP. The M-ATA supports G3 analog fax machines and converts fax signaling into T.38 or G.711 pass through fax for delivery over an Intranet or the Internet. Just configure the M-ATA, plug in the fax machine's phone line, add a LAN connection, and the M-ATA is ready to go!

FEATURES & BENEFITS

- ✓ Ultra-miniature—Smallest full-function analog telephone adapter available today!
- ✓ Supports over 20 voice calling features—Call waiting, call conference, caller ID, hotline, distinctive ring and more!
- ✓ DHCP, PPPoE—Provides maximum connectivity across firewalls and transport networks.
- ✓ SIP Signaling—Deploy into any multimedia, interactive, or softswitch network with the leading call and session signaling protocols.
- ✓ Toll Quality CODECs & T.38 fax—Uses G.723 or G.729 for low-bandwidth applications or standard G.711 or G.726 CODECs for toll-quality voice.
- ✓ Centralized management—HTTP/SNMP manageable from any location.

ORDERING INFORMATION

M-ATA-1/E: Micro Analog Telephone Adapter; 1 x FXS RJ11; 1 x 10/100Base-TX

M-AFA-1/E: Micro Analog FAX Adapter; 1 x FXS RJ11; 1 x 10/100Base-TX, T.38 and G.711 only

SPECIFICATIONS

Voice Connectivity: 2-wire Loopstart, RJ-11/12 • Short haul loop 1.1 km @3REn • Caller-ID Type-1/2 FSK and ITU V.23/Bell 202 generation

Connectivity: 1 10/100Base-TX Full Duplex/Autosensing Ethernet RJ-45

Voice Processing (signalling dependent): SIP • Voice CODECS (G.711 A-Law/μ-Law (64 kbps); G.726 (ADPCM 40, 32, 24, 16 kbps); G.723.1 (5.3 or 6.3 kbps); and G.729ab (8 kbps)) • G.168 echo cancellation • 2 parallel voice connections • DTMF detection and generation • Carrier tone detection and generation • Silence suppression and comfort noise • Configurable dejitter buffer • DTMF in-band & out-of-band • Configurable transmit packet length • RTP/RTCP (RFC 1889) • STUN

Fax and Modem Support: G.711 transparent fax • T.38 fax relay (9.6 k, 14.4 k)

Voice Services/Features: Anonymous CallerID block • Call blocking • Call forward - on busy • Call forward - selective • Call forward - unconditional • Call hold/retrieve • Call return • Call transfer - blind • Call transfer - with consultation • Call waiting/retrieval • Caller-ID • Conference drop • Conferencing (3-way calling) • Distinctive ring • Do not disturb •

Hotline calling • Incoming CallerID on/off • IP URL dialing • Message waiting indication • Self-caller ID block • Speed dial • Voicemail message retrieval • Warmline calling

IP Services: DHCP client • PPPoE • Programmable static routes • ICMP redirect (RFC 792); Packet fragmentation • VLAN support 802.1p/q

Management: Browser configuration interface • Multilevel security access • TFTP & HTTP configuration & firmware loading • SNMP v2 agent (MIB II and private MIB) • Syslog support

Operating Environment: Op. temp.: 0–40°C (32–104°F) Op. humidity: 5–80% (non-condensing)

System: Power: 100–240 VAC (50/60 Hz)

Compliance: EMC compliance: EN55022 and EN55024 • Safety compliance: EN 50950 • CE compliance • FCC Part 15 Class B

Physical: Dimensions: 3.6L x 2.1W x 0.78H in. (9.0L x 5.3W x 1.9H cm) Weight: 0.2 lbs (0.09 kg)

Typical applications

Patton's Micro-Analog Telephone Adapter provides seamless access to Internet telephony and data services. The M-ATA connects to any broadband access provider via a cable or xDSL modem.

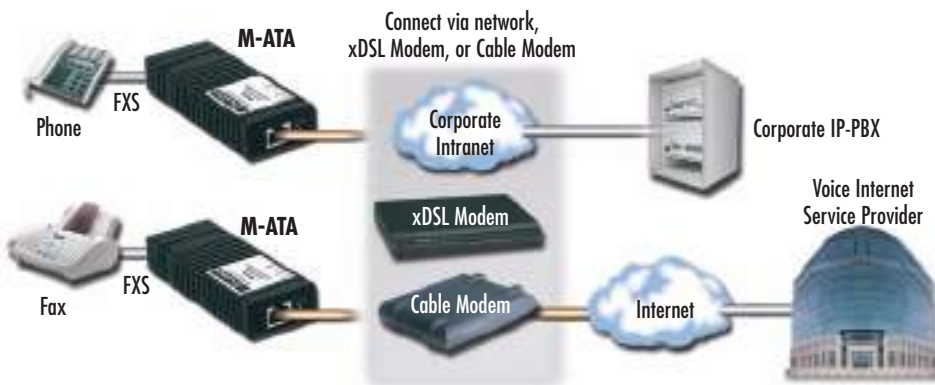

Smart-ATA Residential Analog Telephone Adapter

Model S-ATA

Leverage low-cost packet-voice and IP services for complete residential voice and data connectivity. The Smart-ATA supports full IP routing for transparent voice, fax, and data connections over any IP network.



The Smart Analog Telephone Adapter (S-ATA) provides VoIP connectivity for analog phones and faxes to the world of Internet voice. Connecting to any analog phone or fax, the Smart-ATA product is an effective and flexible solution for consumers and telecommuters to access Internet-based telephone services and corporate intranet systems across established LAN and Internet connections like xDSL and cable modems.

The S-ATA-A1 provides two RJ-45 Ethernet ports and one FXS (RJ-11) analog phone port. The S-ATA-A2 provides two RJ-

45 Ethernet ports and two FXS (RJ-11) analog phone ports. Front panel LEDs quickly show at-a-glance the status of the system, LAN, WAN, and phone ports.

A full suite of IP features (DHCP, NAT/PAT, and NTP) are available to LAN devices attached downstream.

The web interface offers two levels of configuration access for the network operator and end user. Consumer friendly web interface and product labeling (Phone, LAN, WAN etc.) help ensure a trouble-free installation for the end user. Configuration and firmware can be downloaded from a TFTP server.

The Smart-ATA is SIP standard compliant, so it can be used with most SIP-based telephony services. Analog phones attached to the Smart-ATA can use such advanced voice calling features as call forwarding, caller ID, 3-way calling, call holding, call retrieval and call transfer.

FEATURES & BENEFITS

- ✓ Up to 2 FXS ports connect to your standard telephone or PBX.
- ✓ Quality of Service ensures voice traffic gets priority without shutting down your Ethernet LAN.
- ✓ NAT, DHCP, PPPoE—Connect to any broadband or access provider, serve the whole network, and secure your data. User configurable IP services ensure every host is connected to the LAN.
- ✓ SIP signaling—Deploy into any multimedia, interactive, or softswitch network with the leading call and session signaling protocols.
- ✓ Toll Quality CODECs & T.38 fax—Use standard G.711 or G.726 CODECs for toll-quality voice, or G.723 or G.729 for low-bandwidth applications.

ORDERING INFORMATION

S-ATA-A1/EU/S: 1 Phone Port (FXS) Analog Telephone Adapter (ATA), SIP, UI power

S-ATA-A2/EU/S: 2 Phone Port (FXS) Analog Telephone Adapter (ATA), SIP, UI power

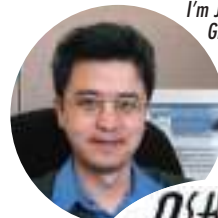

I'm John, one of Patton's VoIP Products Group Managers. If you have technical questions or comments concerning VoIP Products, please call me at +1 (301) 975-1000, x182. You can also send e-mail to jwu@patton.com.



SPECIFICATIONS

Voice Connectivity: 2-wire Loopstart, RJ-11/12 • short haul loop 1.1 km at 3REv • Caller-ID type-1/2 FSK & ITU V.23/Bell 202 generation

Connectivity: 2 10/100 full duplex/autosensing Ethernet RJ-45

Voice Processing (signaling dependent): SIP • MGCP (Packet Cable NCS 1.0 & IETF MGCP 1.0) • Voice codes (G.711 A-Law/μ-Law (64kbps); G.726 (ADPCM 40, 32, 24, 16 kbps); G.723.1 (5.3 or 6.3 kbps); G.729ab (8kbps)) • G.168 echo cancellation • 4 parallel voice connections • DTMF detection & generation • Carrier tone detection & generation • Silence suppression & comfort noise • Configurable dejitter buffer • DTFM in-band & out-of-band • Configurable transmit packet length • RTP/RTCP (RFC 1889)

Fax and Modem Support: G.711 transparent fax • T.38 fax relay (9.6 k, 14.4 k)

Voice Services/Features: Call forwarding • Call transfer • Call hold • Call waiting • 3-way calling

IP Services: IPv4 router: RIPv1, v2 (RFC 1058 and 2453) • IP filtering • NATP • NTP • DHCP client & server • programmable static routes • ICMP redirect (RFC 792); Packet fragmentation

Management: Browser configuration interface • TFTP configuration & firmware loading • SNMP v2 agent (MIB II and private MIB)

Environment: Temp: 32–104°F (0–40°C) • Humidity: 5–80% (non-condensing)

System: Power: 100–240 VAC (50/60 Hz) • Dimensions: 7.1W x 4.3D x 1.1H in. (18.0W x 11.0D x 2.7H cm) • Weight: 14.4 oz (236 g)

Compliance: EMC compliance: EN55022 and EN55024 • Safety compliance: EN 50950 • CE compliance • FCC Part 15 Class B

Local PSTN + Packet Voice

Patton's SmartLink Gateway routers with FXS support seamless access to Internet telephony and data.

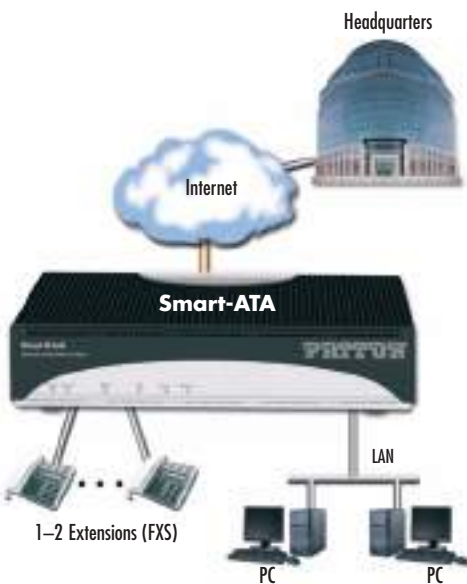

LAN/WAN QoS & Router

As a premise router, the SmartLink offers voice and complete Internet access. With dual 10/100 Ethernet ports, the SmartLink connects your hosts to the LAN with VLAN tagging, DHCP server/client, and Firewall/ACL services. Use PPPoE and IPSEC VPN with DES, 3DES, and AES encryption and bring your Voice and Data to the WAN through a single and secure network connection.

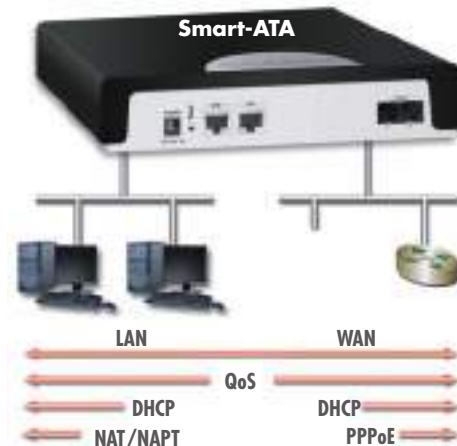

Smart Residential VoIP Analog WiFi Telephone Adapter

Model S-WTA

Take advantage of low-cost VoIP services without sacrificing existing Internet access and connectivity. The S-WTA offers dual channel VoIP, broadband routing and integrated WiFi for a complete residential TriplePlay Ready voice and data solution.



The Residential Smart WiFi Telephone Adapter (S-WTA) delivers connectivity with cost savings for residential and SoHo users. Combining two ports of standards-based VoIP with an integrated broadband WiFi router.

The S-WTA offers dual two-wire FXS phone ports for standard telephones or fax machines. With softswitch-certified SIP signaling, the S-WTA provides seamless toll-quality access to lowest cost VoIP services. The integrated broadband router allows you to connect to any Ethernet-based WAN such as ADSL, cable or fiber services. The integrated 4-port 10/100 LAN switch conveniently connects all of your networking devices. The integrated 802.11 WiFi offers b, g and super-g wireless connections automatically for highest throughput and maximum compatibility. Wireless WPA security with NAT, firewall/statefull packet inspection and denial-of-service support helps keep your network secure and your phone bills low.

FEATURES & BENEFITS

- ✓ 2-call voice & fax FXS ports, 4-port LAN Ethernet switch, 1-port WAN Ethernet and integrated 802.11g WiFi
- ✓ SIP signaling—Deploy into any multimedia, interactive, or voice network with softswitch certified and tested call & session signaling.
- ✓ Integrated firewall/statefull inspection firewall, denial-of-service protection and NAT/DMZ. Wireless security offers WEP, WPA, WPA2, and 802.1x wireless security support.
- ✓ Complete TriplePlay multimedia and IPTV support with IGMP snooping and proxy. Integrated QoS for ensured voice, data, and multimedia quality.
- ✓ Toll quality and low-bandwidth CODECs. T.38 and fax-bypass features for solid multiuse interoperability.
- ✓ Single tightly integrated solution perfect for provider-based competitive calling and bundled data services.

ORDERING INFORMATION

S-WTA/G: 2-Port FXS VoIP Telephony Adapter with Broadband Router and Integrated 802.11b/g WiFi; 100–240 VAC external power supply (PS)

Remote Office/Branch Office Voice Extension and Access diagram



SPECIFICATIONS

Voice Connectivity: Two FXS 2-wire loopstart, RJ-11 • 5 REN • EuroPOTS (ETSI EG201 188) • programmable AC impedance, feeding, & ring voltage; on-hook voltage 50Vrms nominal • Caller-ID Type-1/2 FSK and ITU V.23/Bell 202 generation. Voice codes (G.711 A-Law/μ-Law (64kbps). Voice Processing: G.726 ADPCM; G.723.1 (5.3 or 6.3 kbps);

G.729abe • G.168 echo cancellation • SIPv2 • DTMF detection & generation • carrier tone detection & generation • silence suppression & comfort noise • configurable dejitter buffer • configurable tones (dial, ringing, busy) • configurable transmit packet length • RTP/RTCP (RFC 1889) **Fax and Modem Support:** G.711 transparent fax • Fax over IP (FoIP)

• T.38 fax relay (9.6 k, 14.4 k) **IP Services: complete** IPv4 router; DHCP server, PPPoE, NAT, DMZ with Configurable SPI Firewall and DoS protection • DiffServe/ToS set for queue per header bits • Packet Policing discards excess traffic • 802.1p/Q VLAN support with 4096 IDs • AES/DES/3DES encryption options

Connectivity: WAN - Single 10/100 Ethernet RJ-45; LAN - Four RJ-45 switch ports; Integrated WiFi - dual diversity antenna. LAN switched with full country channel selection (US, Canada, Japan, Euro) at 2.4Ghz; autorate speed from 1-54 Mbps with Super-G burst support to 108 Mbps. Up to 23 dBm transmit power. data rate 54 Mbps.

Voice Routing—Session Router: Local switching; Interface hunt-groups • Routing Criteria **Management:** HTTP/CLI with local console and remote Telnet/SSH access • TFTP configuration & firmware loading • SNMP v1 agent (MIB II and private MIB) • Built-in diagnostic tools (trace, debug) **Environment:** Temp: 32–104°F

(0–40°C) • Humidity: 5–80% (non condensing) Power: 100–240 VAC (50/60 Hz) • Power dissipation: 4W **Compliance:** EMC compliance: EN55022 and EN55024 • Safety compliance: EN 50950 • CE compliance • FCC Part 15 Class A

Smart-DTA Residential Digital Telephone Adapter

Model S-DTA

The S-DTA brings all advantages of VoIP to ISDN users. It connects multiple terminals to its BRI So bus, and converts 2 concurrent voice or fax calls to SIP or H.323—at an incredibly low price.



The Smart-DTA enables integration of ISDN network users into a local VoIP phone service, or extends an ISDN line of a PBX to a remote site over IP. It offers a simple end-user configuration interface and connects both to a PBX in point-to-point mode and an So bus in point-multipoint mode.

Unlike most other products on the market, Patton's intelligent call routing technology does not only offer simple ISDN

to VoIP, but also advanced features like number plan adaptations, mappings between ISDN and SIP/H.323, manipulation of call properties through regular expressions, routing calls based on time-of-day or bearer capability criteria and much more.

Providing power to the ISDN line, the S-DTA eliminates the need for an external power supply to provide power to the terminals. Gateway functions use standard CODECs such as G.723, G.729, and T.38 fax as well as industry standard SIP, H.323 and MGCP/IUA signaling protocols to ensure seamless connection and compatibility for all voice services. Quality of service (QoS) features complete the offering with advanced voice prioritization and traffic management including VLAN and 802.1p/Q tagging.

FEATURES & BENEFITS

- ✓ Instant ISDN to VoIP Connectivity—Provides one internally powered So bus for up to 8 terminals. Simultaneously converts 2 voice and fax calls to VoIP.
- ✓ Transparent Telephony Features—Preserves ISDN features like caller ID and name (CLIP/CLIR), call transfer, hold, waiting, charging information (AOC) and much more.
- ✓ Outstanding Interoperability—Interoperable for voice and fax calls with a wide variety of ISDN terminals, PBXs, as well as SIP and H.323 soft switches and application servers.
- ✓ Full SIP and T.38 support—Complete range of industry standard signaling protocols supported: SIPv2, H.323v4, MGCP/IUA, ISDN, BRI, T.38, fax and modem bypass, DTMF relay
- ✓ Integrated Management and Provisioning—Web GUI for easy end-user setup, fully automated provisioning system and SNMP management for mass deployment

Network Integration

Patton's Smart Digital Telephony Adapter provides seamless access to Internet telephony services for ISDN terminals. The S-DTA connects to any LAN or broadband access provider via modem.

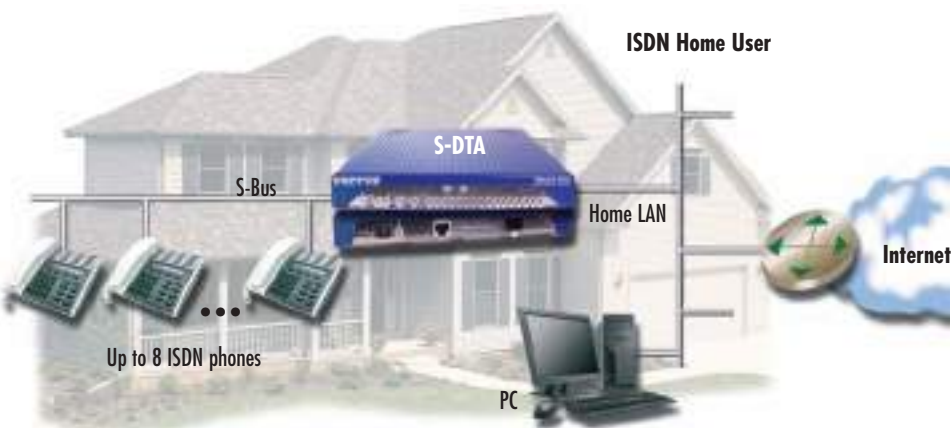

I'm Michael, Associate Product Manager for VoIP. If you have technical questions or comments concerning VoIP Products, please call me at +1 301.975.1000, x202. You can also send e-mail to mhuarca@patton.com.



SPECIFICATIONS

WAN Connectivity: 10/100Base-T Ethernet WAN • Auto-MDI-X • DHCP Client • PPPoE Client (multi-session) • SNMP • IP Multi-Netting

IP Quality of Service: IEEE 802.1p, TOS, DiffServ Labeling • IEEE 802.1Q, VLAN Tag insertion/deletion (4,096 VLANs)

Management: Web-based GUI • Fully documented CLI • Telnet and HTTP access • TFTP configuration up- and download • TFTP firmware upgrade • SNMPv1 agent, MIB II and enterprise MIB • Built-in diagnostic tools • Auto-Provisioning—Configuration and Firmware

Fax and Modem Support: T.38 fax over IP • Fax relay and bypass • Modem bypass

ISDN Specification: 1 port Euro-ISDN BRI/So RJ-45, NT • DSS-1, Q.921, Q.931 • Point-point & point-multipoint

Voice Signaling: SIPv2 • H.323v4 • MGCP/IUA • SIP call transfer, redirect • Overlap or on-band dialing • DTMF in-band & out-of-band • Configurable call progress tones

Call Routing & Services:

- Regular expression number matching
- Regular expression number manipulation
- Least Cost Routing
- Number blocking
- Short-Dialing
- Digit collection
- Distribution-Groups & Hunt-Groups
- 2nd call offering

Voice Processing: G.723.1 (5.3/6.3 kbps) • G.729, G.729a, G.729ab (8 kbps) • G.726 ADPCM (16, 24, 32, 40 kbps) • G.168 echo cancellation (25ms) • Transparent ISDN data • Silence suppression and comfort noise • Adaptive and configurable dejitter buffer • Configurable packet length

Power & Packaging: Dimensions: 4.2W x 1.5H x 5.0D in. (10.6W x 3.9H x 12.7D cm) • Weight: < 15.9 oz (450 g) • Power Consumption < 4W

Environment: Temp.: 32–104°F (0–40°C) • Humidity: up to 90%, non condensing

Compliance: FCC Part 15 Class B (US EMC) • CE per RTTE 99/5/EC (EMC and LVD) • Safety—EN60950 • TBR-3 (ISDN BRI/So)

ORDERING INFORMATION

S-DTA/EUI: ISDN VoIP adapter, 1x BRI/So, 2 voice/fax calls, 1x 10/100 Ethernet, external UI power (100–240 VAC)

visit us online
www.patton.com

FAST Delivery From Your AUTHORIZED DISTRIBUTOR!



Analog VoIP SoHo Router

SmartLink™ 4020 Series

The SmartLink 4020 VoIP SoHo Router connects your LAN, standard analog phones, and fax to any IP network. This full-featured IP router includes VPN/Security and Quality of Service for converged low-cost sales-office/telecommuter voice data communications.



The SmartLink VoIP SoHo Router provides transparent connectivity for analog phones and faxes to the world of Internet voice. Connecting to any analog phone, fax or PBX, the SmartLink product is an effective and flexible solution for small offices and telecommuters to access Internet-based telephone services and corporate intranet systems across established LAN and Internet connections like xDSL and cable modems.

The SmartLink Model 4021 provides two RJ-45 Ethernet ports and one FXS (RJ-11) analog phone port. The SmartLink Model 4022 provides two RJ-45 Ethernet ports and two FXS (RJ-11)

analog phone ports. Front panel LEDs quickly show at-a-glance the status of the system, LAN, WAN, and phone ports.

A full suite of IP features (DHCP, NAT/PAT, NTP and VPN) are available to LAN devices attached downstream. VLAN tagging and prioritization enables voice traffic to be handled before data traffic. Support for PPPoE and IPSEC tunneling simplifies extending corporate intranet services to remote teleworkers.

The web interface offers two levels of configuration access for the network operator and end user. The friendly web interface and product labeling (Phone, LAN, WAN etc.) to help ensure a trouble-free installation for the end user. Configuration and firmware can be downloaded from a TFTP server.

The SmartLink is SIP standard compliant, so it can be used with most SIP-based telephony services. Analog phones attached to the SmartLink can use such advanced voice calling features as call forwarding, caller ID, 3-way calling, call holding, call retrieval and call transfer.

FEATURES & BENEFITS

- ✓ Up to 2 FXS ports connect to a standard phone or PBX.
- ✓ Quality of Service ensures voice traffic gets priority without shutting down your Ethernet LAN.
- ✓ Firewall, NAT, DHCP, PPPoE—Connect to any broadband access provider, serve the whole network, and secure your data. User configurable IP services ensure every host is connected to the LAN.
- ✓ SIP Signaling—Deploy into any multimedia, interactive, or softswitch network with the leading call and session signaling protocols.
- ✓ Toll Quality CODECs & T.38 fax—Uses standard G.711 or G.726 CODECs for toll-quality voice, or G.723 or G.729 for low-bandwidth applications.

ORDERING INFORMATION

SN4021/EUJ/S: 1 Port FXS VoIP Gateway Router, 100–240 VAC external power supply (PS), SIP

SN4021/EUJ/M: 1 Port FXS VoIP Gateway Router, 100–240 VAC external PS, MGCP

SN4022/EUJ/S: 2 Port FXS VoIP Gateway Router, 100–240 VAC external PS, SIP

SN4022/EUJ/M: 2 Port FXS VoIP Gateway Router, 100–240 VAC external PS, MGCP

SPECIFICATIONS

Voice Connectivity: 2-wire loop-start, RJ-11/12 • short haul loop 1.1 km @3REH • Caller-ID Type-1/2 FSK & ITU V.23/Bell 202 generation

Voice Processing (signaling dependent): SIP • MGCP (Packet Cable NCS 1.0 & IETF MGCP 1.0) • Voice CODECs (G.711 A-Law/μ-Law (64 kbps); G.726 (ADPCM 40, 32, 24, 16 kbps); G.723.1 (5.3 or 6.3 kbps); G.729ab (8 kbps)) • G.168 echo cancellation • 4 parallel voice connections • DTMF detection & generation • carrier tone detection & generation • silence suppression & comfort noise • configurable dejitter buffer • DTMF in-band & out-of-band • configurable transmit packet length • RTP/RTCP (RFC 1889)

Voice Services/Features: Call forwarding • Call transfer • Call hold • Call waiting • 3-way calling

IP Services: IPv4 router; RIPv1, v2 (RFC 1058 & 2453) • IP filtering • NAT • NTP • DHCP client & server • PPPoE • IPSEC VPN • programmable

static routes • ICMP redirect (RFC 792); Packet fragmentation • DiffServe/ToS set or queue per header bits • VLAN support 802.1p/q • AES/DES/3DES encryption

Fax and Modem Support: G.711 transparent fax & T.38 fax relay (9.6 k, 14.4 k)

Connectivity: 2 10/100 Full Duplex/Autosensing Ethernet RJ-45

Management: Browser configuration interface • TFTP configuration & firmware loading • SNMP v2 agent (MIB II & private MIB)

Environment: Temp.: 32–104°F (0–40°C) • Humidity: 5–80% (non condensing)

System: Power: 100–240 VAC (50/60 Hz)

Compliance: EMC compliance: EN55022 & EN55024 • Safety compliance: EN 50950 • CE compliance • FCC Part 15 Class B

Local PSTN + Packet Voice

Using Patton's SmartLink VoIP SoHo routers with FXS supports seamless access to Internet telephony and data.

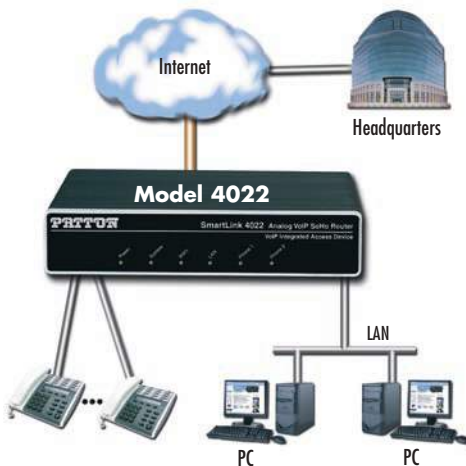

LAN/WAN QoS & Router

As a premise router, the SmartLink offers voice and complete Internet access. With dual 10/100 Ethernet ports, the SmartLink connects hosts to your LAN with VLAN tagging, DHCP server/client, and Firewall/ACL services. Use PPPoE and IPSEC VPN with DES, 3DES, and AES encryption and bring your voice and data to the WAN through a single and secure network connection.

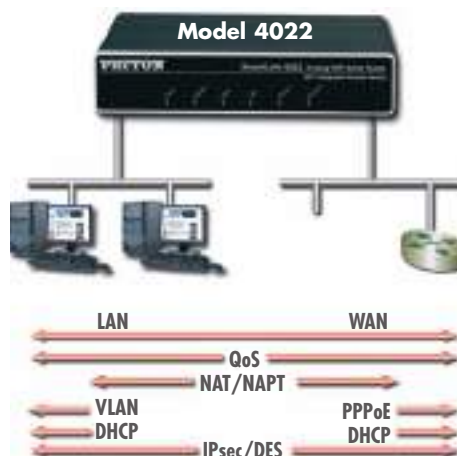

Multi-Port FXS/FXO VoIP Gateway Series

SmartNode™ 4110 Series

The SmartNode 4110 VoIP gateway integrates up to eight legacy PSTN, PBX or standard phone lines with next-generation IP based telephony systems. Part of the proven SmartNode family, this product is designed to provide superior technology at an optimized cost.



The SmartNode 4110 VoIP Media Gateway supports up to eight transparent phone calls while leveraging VoIP for lower-cost carrier and corporate access. Connecting to any analog phone, fax, or PBX, the SN4110 is an effective and flexible solution for toll-bypass, remote/branch office voice connectivity, and enhanced carrier services.

The SN4110 series is the perfect choice for phone-to-IP connectivity supporting up to 8 FXS ports or a combination of 4

FXS and 2 or 4 FXO ports. With its FXS analog ports, the SN4110 connects to any legacy telephone or PBX and provides dial-tone, ringing, and caller-ID. When equipped with FXO ports, the local PSTN can be accessed enabling local calling and enhanced toll-bypass applications while using a single connected telephone. Flexible call integration allows per-port telephone numbers, programmable call progress tones, and distinctive ringing. With Telephony-over-IP (ToIP) call switching, calls can automatically select the least-cost-route while providing flexible numbering plans and end-to-end feature transparency. PPPoE, DHCP, and VLAN offers universal IP connectivity and optional IPSEC VPN with AES/3DES guarantees secure voice over the public network.

Patton's SmartNode 4110 delivers the legacy phone interfaces, service transparency, and flexible PSTN integration required for true converged packet voice.

FEATURES & BENEFITS

- ✓ Up to 8 FXS and/or FXO ports—Compact, reliable stand-alone VoIP gateway with different port options. Supports simultaneous voice or fax calls on all ports.
- ✓ Advanced Local Call Switching—Virtual interfaces and routing tables provide industry leading flexibility in call handling programming. Local call switching, soft fallback to alternative routes. Simultaneously connects to multiple SIP services/IP PBXs.
- ✓ Complete SIP and T.38 support—Supports the complete range of industry standard VoIP: SIP, H.323, T.38 fax, fax and modem handling, DTMF relay. Codecs G.729, G.723, etc.
- ✓ Easy Management & Provisioning—Web-based management, SNMP, command line interface. Automated mass provisioning for efficient large-scale deployments.
- ✓ Outstanding Interoperability—Proven integration for voice and T.38 fax with Asterisk™, PingTel™ and other leading IP PBX systems and soft switch vendors.

Remote Office/Branch Office Voice Extension and Access diagram



ORDERING INFORMATION

- SN4112/JS/EUI: 2 Port FXS VoIP Media Gateway, 100–240 VAC external power supply (PS)
- SN4114/JS/EUI: 4 Port FXS VoIP Media Gateway, 100–240 VAC external PS
- SN4116/JS/EUI: 6 Port FXS VoIP Media Gateway, 100–240 VAC external PS
- SN4118/JS/EUI: 8 Port FXS VoIP Media Gateway, 100–240 VAC external PS
- SN4114/2JS2JO/UI: 2 FXS & 2 FXO Port VoIP Media Gateway, 100–240 VAC internal PS
- SN4118/4JS4JO/EUI: 4 FXS & 4 FXO Port VoIP Media Gateway, 100–240 VAC external PS

Options & Accessories

SNSW-VPN1: License Key for IPsec VPN support (DES, 3DES, AES)

SPECIFICATIONS

Capacity: Up to 8 simultaneous VoIP or T.38 fax calls (depending on the model)
Voice Signaling: H.323v4, SIPv2 (B2BUA capable, multi-instance, simultaneous support of multiple registrars and direct IP dialing) • SIP call transfer, redirect • DTMF in-band & out-of-band • All tones programmable (dial, ringing, busy)
Voice Processing: CODEC G.711 a-law/mu-law, G.723, G.729ab, • G.726,

G.727, T.38 fax relay (9.6 k, 14.4 k) • G.711 transparent fax and bypass
Call Switching and Services: Virtual interfaces • Regular expression based call routing and number manipulation • Number blocking • Short-dialing • Digit collection, distribution and hunt groups • Transparent line extension • Fallback Routing: Soft fallback to alternative route(s)

FXS Connectivity: 2-wire Loopstart on RJ-11/12 • short haul loop 1.1km @3REN • EuroPOTS (ETSI EG201188) • programmable AC impedance, feeding, ring and on-hook voltage • Caller-ID FSK and ITU V.23/Bell 202 generation
FXO Connectivity: 2-wire Loopstart on RJ-11/12 • Programmable impedance, ring detection, tone detection, disconnect supervision • Caller ID detection

IP services: One 10/100 Ethernet port • DHCP Client • access control lists • Traffic policing • IEEE 802.1p, TOS, DiffServ labeling • IEEE 802.1Q, VLAN tag insertion/deletion (simultaneous support of multiple VLANs) • IPSEC, IKE, AES/DES/3DES Encryption (optional)
Management: Web/HTTP, CLI with local console and remote Telnet access • TFTP configuration & firmware loading •

SNMP MIB II and product MIB • Secure Mass provisioning for both firmware and unit/subscriber configuration • Built-in diagnostic tools (trace, debug, call generator)
System: CPU Motorola MPC870 @ 66MHz • Memory 32MB SDRAM/8MB Flash • Power 100–240 VAC (50/60 Hz) • Power dissipation 4–12W, model dependent

Environment: Temp.: 32–104°F (0–40°C) Humidity: 5–80% (non condensing)
Compliance: EMC compliance: EN55022 and EN55024 • Safety compliance: EN 60950 • CE compliance • FCC Part 15 Class A • TBR21 (FXS) • RoHS

visit us online
www.patton.com

FAST Delivery From Your AUTHORIZED DISTRIBUTOR!



Small & Branch Office ISDN VoIP Routers

SmartNode™ 4552 (Standard) & 4562 (Secure)

The SmartNode 4552 and 4562 are the perfectly integrated devices to take branch office connectivity to the next level. Combining VoIP, ISDN and IP access routing, they enable the cost savings of VoIP while preserving speech and fax quality and reliability.



The SmartNode 4552 and 4562 enable the integration of ISDN branch offices or remote users into corporate voice and data networks. They attach any standard ISDN telephone or PBX to a public or corporate VoIP service, generating lots of communication cost savings without having to sacrifice quality.

Industry-leading call switching features include hard and soft communication fallback to the ISDN breakout port in the event of failure, ensuring that no services are interrupted when migrating to VoIP.

The SmartNode 4562 adds hardware accelerated encryption power to the impressive feature list of the SmartNode

4552, making VoIP accessible to organizations that have been missing out on the cost-saving benefits of Internet telephony because of security concerns.

With the ClearConnect™ dial-backup option, adaptive network monitoring recognizes WAN uplink failures and initiates an ISDN dial-up connection to guarantee interrupt-free voice and data access at all times. If the VoIP link goes down or becomes congested, the SN4552 will switch over to the PSTN and guarantee your call each time.

Broadband network connectivity integrates with any fixed IP, DHCP or PPPoE service. An integrated 10/100 Ethernet LAN switch, with advanced routing features such as multiple VLANs, NAT, Firewall/ACL or DynDNS fulfills the requirements of demanding network users. Quality of Service (QoS) features complete the offering with advanced voice prioritization and traffic management. Patton's patent-pending DownStreamQoS™ ensures voice without interruptions even over best-effort Internet connections.

FEATURES & BENEFITS

- ✓ Full SIP and T.38 support — Complete range of industry standard signaling protocols supported: SIPv2, H.323v4, MGCP/IUA, DSS1, Euro-ISDN, VN4, T.38 fax, fax and modem bypass, DTMF relay.
- ✓ Toll-Quality VoIP — Advanced traffic management and shaping, combined with Patton's patent-pending DownStream QoS™ enforce uninterrupted toll-quality voice over best-effort networks.
- ✓ Transparent Telephony Features — Preserves ISDN features like caller ID and name (CLIP/CLIR), call transfer, hold, waiting, AOC and much more. Handles complex number manipulation for most seamless integration with existing infrastructure.
- ✓ Management & Provisioning — Built-in Web based management, SNMP, Command Line Interface and Auto-Provisioning for automated configuration distribution and software upgrades.
- ✓ Accelerated Voice over VPN* — Encrypts voice, signaling and data traffic over IP networks with IPsec, AES, 3DES and IKE. Complete access router with NAT, firewall, PPPoE, DHCP and DynDNS.
- ✓ ClearConnect™ dial-backup option for survivable voice and data connectivity.

ORDERING INFORMATION

SN4552/2BIS/EUI: ISDN BRI VoIP SoHo Router, 2-port, 10/100Base-T WAN, 4-port 10/100Base-T switch 100–240 VAC external power supply

SN4562/2BIS/EUI: SmartNode ISDN Voice over VPN Router, 2 port, 10/100Base-T WAN, 4-port 10/100Base-T LAN switch, 100–240 VAC external power supply. Includes VPN license key for IPsec VPN, IKE and Voice-Over-VPN. Hardware accelerated cryptography.

Options & Accessories

PM-BRI-EXT: External S-Bus Phantom-Power Supply 40 VDC for Phone only (required to provide power to telephones)

SNSW-QSIG1: License Key for QSIG support

SNSW-DB1: Dial-Backup Feature License

* Available on SN4562 only

Network Integration



SPECIFICATIONS

Capacity: 2 simultaneous VoIP or T.38 fax calls

ISDN Connectivity: 2 ports Euro-ISDN BRI/So RJ-45 • 1 NT port/1 TE port • DSS-1, Q.921, Q.931 • Point-point and point-multipoint • Lifeline Bypass Relay TE port to NT port • Optional QSIG support

VoIP Signaling: SIPv2 (B2BUA capable, multi-instance, supports registrar and direct IP dialing at the same time) •

H.323v4 • MGCP/IUA • SIP call transfer, redirect • DTMF in-band & out-of-band • All tones programmable (dial, ringing, busy) • Overlap or en-bloc dialing • Transparent AOC, ECT, CLIP, CLIR, etc • speech, audio & data (Fax Gr 4, UDI 64, • RDI 64);

Voice Processing: CODEC G.711 a-law/mu-law, G.723, G.729ab, G.726, G.727, T.38 fax relay (9.6 k, 14.4 k) • G.711 transparent fax and bypass

LAN and IP Services: 4-port LAN Switch • Auto-MDI-X • IPv4, RIPv2, ICMP • Dynamic and static NAT and NAPT • ACL Firewall • DNS, DynDNS • DHCP Server • SMTP Client • IPSEC, IKE, AES/DES/3DES Encryption (hardware accelerated, on model 4562 only)

WAN Connectivity: 10/100BaseT Ethernet WAN • Auto-MDI-X • DHCP

Client • PPPoE Client (multi-session) • IP Multi-Netting

Quality of Service: Voice priority • DownStreamQoS™ • Traffic management, shaping and policing • IEEE 802.1p, TOS, DiffServ labeling • IEEE 802.1Q, VLAN tag insertion/deletion (simultaneous support of multiple VLANs and PPPoE sessions)

Management: Web/HTTP, CLI with local console and remote Telnet access • TFTP configuration & firmware loading • SNMP MIB II and product MIB • Secure mass provisioning for both firmware and unit/subscriber configuration • Built-in diagnostic tools (trace, debug, call generator)

System: CPU Motorola MPC870 @ 66MHz • Memory 32MB SDRAM/8MB

Flash • Power 100–240 VAC (50/60 Hz) • Power dissipation 4–12W, model dependent

Environment: Temp.: 0–40°C • Humidity: 5–80% (non condensing)

Compliance: EMC compliance: EN55022 and EN55024 • Safety compliance: EN 60950 • CE compliance • FCC Part 15 Class A • TBR3 (ISDN) • RoHS

ISDN BRI PSTN Gateway

SmartNode™ 4554

The SmartNode™ 4554 ISDN VoIP PSTN gateway enables any IPBX or IP phone system to seamlessly connect to the ISDN PSTN. The compact, reliable design allows easy and flexible integration of BRI lines into any VoIP system.



The SmartNode™ 4554 ISDN BRI PSTN Gateway converts up to four simultaneous phone or T.38 fax calls from SIP or H.323 to BRI ISDN. It is a compact reliable stand-alone VoIP gateway for IP-based voice systems that delivers ISDN performance and quality.

For system integrators looking for a VoIP solution with ISDN connectivity, the SmartNode 4554 provides unparalleled ISDN to IP preservation. The SmartNode provides advanced

ISDN functionality such as Explicit Call Transfer (ECT) support, and Advice of Charge (AOC) over SIP. Patton CPEs are also interoperable with several leading IP PBX vendors such as Asterisk, 3CX, and SIP Foundry.

Compared to PC-based solutions that combine IP PBX and a PCI BRI cards, the SmartNode has several advantages, including: installation without additional drivers or software, operation without ventilation or hard disk, scaleable without limitation, and service integration without downtime. SmartNodes can be combined in a cluster for simple and flexible redundancy solutions not available with PCI BRI cards. System administrators don't have to learn ISDN as industry standard protocols like SIP and H.323 do the job of connecting the PSTN to your VoIP system.

FEATURES & BENEFITS

- ✓ Four Simultaneous SIP or T.38 calls—Connects an IP PBX or other VoIP systems to the ISDN PSTN with 2 BRI TE ports and 4 simultaneous voice or fax calls.
- ✓ Full VoIP Support—Supports the complete range of industry standard VoIP: SIP, H.323, T.38 Fax, Fax and modem bypass, DTMF relay, Codecs G.729, G.723, and G.711.
- ✓ Transparent Telephony Features—Preserves ISDN features like caller ID and name (CLIP/CLIR), call transfer, hold, waiting, ECT, AOC. Supports DDI and MSN lines in all major countries as well as complex numbering plan manipulations.
- ✓ Outstanding Interoperability—Interoperable for voice and T.38 fax with Asterisk™, 3CX™, PingTel™ and other leading IP PBX systems.
- ✓ Management & Provisioning—Built-in Web-based management, SNMP, Command Line Interface and Auto-Provisioning for automated configuration distribution and software upgrades.

ORDERING INFORMATION

SN4554/2BIS/EUI: ISDN BRI VoIP Gateway, 2 BRI ports, 1 Ethernet port, 4 simultaneous calls, 100–240 VAC external power supply

Options & Accessories

SNSW-VPN1: License Key for IPsec VPN support (DES, 3DES, AES)

SNSW-QSIG1: License Key for QSIG support

SPECIFICATIONS

WAN Connectivity: 10/100Base-T Ethernet WAN • Auto-MDI-X • DHCP Client • PPPoE Client (multi-session) • SNMP • IP Multi-Netting
IP Quality of Service: IEEE 802.1p, TOS, DiffServ Labeling • IEEE 802.1Q, VLAN Tag insertion/deletion 4,096

Management: Web-based GUI • Fully documented CLI • Telnet and HTTP access • TFTP configuration up- and download • TFTP firmware upgrade • SNMPv1 agent, MIB II and enterprise MIB • Built-in diagnostic tools • Auto-provisioning—configuration and firmware
Fax and Modem Support: T.38 fax over IP • Fax relay and bypass • Modem bypass

ISDN Specification: 2 port Euro-ISDN BRI/So RJ-45, TE • DSS-1, Q.921, Q.931 • Point-to-point & point-multipoint
Voice Signaling: SIPv2 • H.323v4 • MGCP/IUA • SIP call transfer, redirect • Overlap or en-bloc dialing • DTMF in-band & out-of-band • Configurable call progress tones

Call Routing & Services: Regular expression number matching • Regular expression number manipulation • Least Cost Routing • Number blocking • Short-Dialing • Digit collection • Distribution- & Hunt-Groups • 2nd call offering
Voice Processing: G.711, /A-law • G.723.1 (5.3/6.3 kbps) • G.729, G.729a, G.729ab (8 kbps) • G.726 ADPCM (16, 24, 32, 40 kbps) • G.168 echo cancellation (25ms) • Transparent ISDN data • Silence suppression and comfort noise • Adaptive and configurable dejitter buffer • Configurable packet length
Dimensions: 4.2W x 1.5H x 5.0D in. (10.6W x 3.9H x 12.7D cm)
Weight: < 15.9 oz (450 g) • Power Consumption < 4W
Environment: Temp.: 32–104°F (0–40°C) • Humidity: up to 90% , non condensing
Compliance: FCC Part 15 Class A (US EMC) • CE per RTTE 99/5/EC (EMC and LVD) • Safety - EN60950 • TBR-3 (ISDN BRI/So)

Application diagram

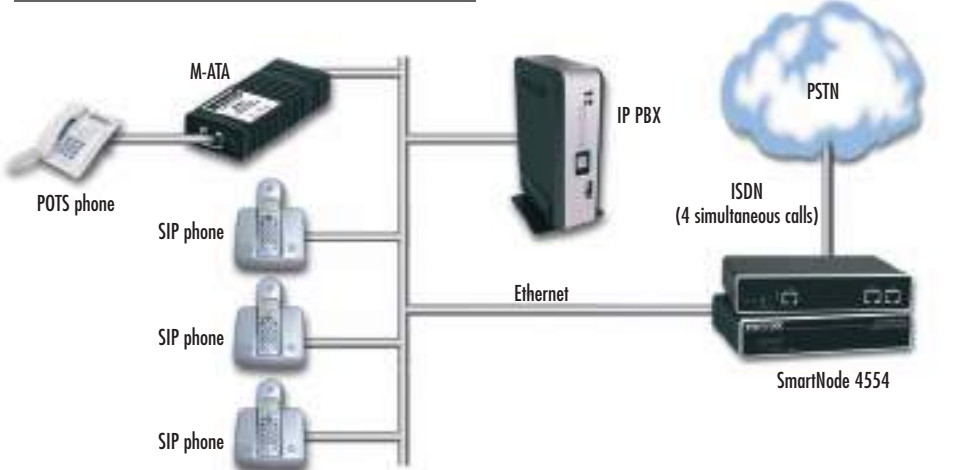

I'm Jen, one of Patton's Sales Associates. Call me at +1 301.975.1000 when you want to purchase Patton products or if you have questions about our products. You can also send e-mail to sales@patton.com.

visit us online
www.patton.com

FAST Delivery From Your AUTHORIZED DISTRIBUTOR!

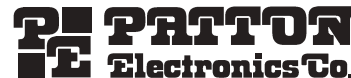

Multi-Port FXS/FXO VoIP Gateway Router

SmartNode™ 4520 Series

The SmartNode 4520 VoIP Gateway Router combines IP routing, VPN/Security, and Quality of Service for up to 8 transparent voice, fax, and data over any IP or PSTN network. Leverage low-cost packet-voice and IP services for complete branch office voice and data connectivity.



Connect with confidence using the SmartNode 4520 Series Router. Integrating a complete enterprise router with local PSTN and remote packet-voice, the SN4520 supports eight simultaneous calls for a new standard in toll-bypass, remote/branch office connectivity, and enhanced carrier services.

Perfect for the remote office, branch office, or PBX/switch extension, the SmartNode 4520 integrates all your voice,

fax, and LAN traffic for seamless and secure networking. With its FXS analog ports the SN4520 connects to any legacy telephone or PBX and provides dial-tone, ringing, and caller-ID. When equipped with FXO ports, the local PSTN can be accessed enabling local calling and enhanced toll-bypass service.

With dual 10/100 Ethernet ports, the SN4520 provides guaranteed Quality of Service while passing LAN traffic at wire-speed. Voice traffic is prioritized while LAN/IP traffic shaping permits efficient access to the Internet and corporate networks. As a complete enterprise router, the SN4520 supports DHCP, NAT, Firewall/ACL, and PPPoE clients. While optional IPSEC VPN and VLAN features tunnel data and AES/3DES ensures secure voice over the public network.

FEATURES & BENEFITS

- ✓ Up to 8 analog ports—Compact, reliable stand-alone VoIP gateway with different port options. Supports simultaneous voice or fax calls on all ports.
- ✓ Toll-Quality VoIP—Advanced traffic management and shaping, combined with Patton's patent-pending DownStream QoS™ enforce uninterrupted toll-quality voice over best-effort networks.
- ✓ Advanced Local Call Switching—Virtual interfaces and routing tables provide industry leading flexibility in call handling programming. Local call switching, soft fallback to alternative routes. Simultaneously connects to multiple SIP services/IP PBXs.
- ✓ Complete SIP and T.38 support—Supports the complete range of industry standard VoIP: SIP, H.323, T.38 fax, fax and modem handling, DTMF relay. Codecs G.729, G.723, and so on.
- ✓ Easy Management & Provisioning—Web-based management, SNMP, command line interface. Automated mass provisioning for efficient large-scale deployments.
- ✓ Outstanding Interoperability—Proven integration for voice and T.38 fax with Asterisk™, PingTel™ and other leading IP PBX systems and soft switch vendors.

Remote Office/Branch Office Voice Extension and Access

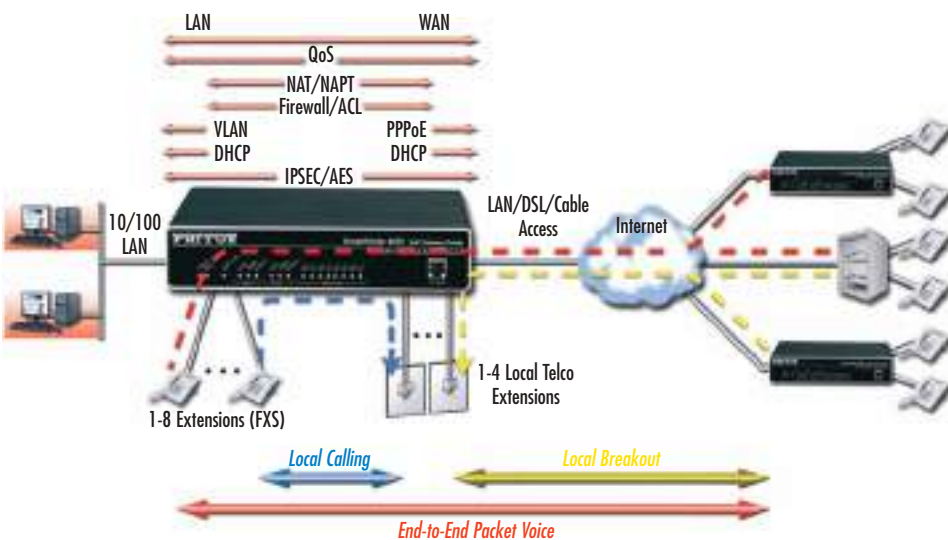

ORDERING INFORMATION

SN4522/JS/EUI: 2 port FXS VoIP Gateway Router, 100–240 VAC external power supply (PS)

SN4522/JO: 2 port FXO Gateway Router

SN4524/JS/EUI: 4 port FXS VoIP Gateway Router

SN4522/JO: 4 port FXO Gateway Router

SN4526/4JS2JO: 4 port FXS 2 port FXO Gateway Router

SN4526/JS/EUI: 6 port FXS VoIP Gateway Router

SN4528/JS/EUI: 8 port FXS VoIP Gateway Router

SN4524/2JS2JO/EUI: 2 port FXS, 2 Port FXO Gateway Router

SN4528/4JS4JO/EUI: 4 port FXS, 4 Port FXO Gateway Router

Options & Accessories

SNSW-VPN1: License Key for IPSEC VPN support (DES, 3DES, AES)

SPECIFICATIONS

Capacity: Up to 8 simultaneous VoIP or T.38 fax calls (depending on the model)

Voice Signaling: H.323v4, SIPv2 (B2BUA capable, multi-instance, simultaneous support of multiple registrars and direct IP dialing) • SIP call transfer, redirect • DTMF in-band and out-of-band • All tones programmable (dial, ringing, busy)

Voice Processing: CODEC G.711 a-law/mu-law, G.723, G.729ab, G.726, G.727, T.38 fax relay (9.6 k, 14.4 k) • G.711 transparent fax and bypass

Call Switching and Services:

Virtual interfaces • Regular expression based call routing and number manipulation • Number blocking • Short-dialing • Digit collection, distribution and hunt groups • Transparent line extension • Fallback Routing: Soft fallback to alternative route(s)

FXS Connectivity: 2-wire Loopstart on RJ-11/12 • short haul loop 1.1km @3REN • EuroPOTS (ETSI EG201188) • programmable AC impedance, feeding, ring and on-hook voltage • Caller-ID FSK and ITU V.23/Bell 202 generation

FXO Connectivity: 2-wire Loopstart on RJ-11/12 • Programmable impedance, ring detection, tone detection, disconnect supervision • Caller ID detection

Data Services: Two 10/100 Ethernet ports • Complete IP access router

• DHCP Client & server • Packet fragmentation • Static firewall, NAT, NAPT RFC 1631 access control lists • DMZ port • IPSEC, IKE, AES/DES/3DES Encryption (optional, hardware accelerated)

Quality of Service: Voice priority • DownStreamQoS™ • Traffic management, shaping and policing • IEEE 802.1p, TOS, DiffServ labeling • IEEE 802.1Q, VLAN tag insertion/deletion (simultaneous support of multiple VLANs)

Management: Web/HTTP, CLI with local console and remote Telnet access • TFTP configuration & firmware loading • SNMP MIB II and product MIB • Secure Mass provisioning for both firmware and unit/subscriber configuration • Built-in diagnostic tools (trace, debug, call generator)

System: CPU Motorola MPC875 @ 66MHz • Memory 32MB SDRAM/8MB Flash • Power 100–240 VAC (50/60 Hz) • Power dissipation 4-12W, model dependent

Temperature: 32–104°F (0–40°C)

Humidity: 5–80%, non-condensing
Compliance: EMC compliance: EN55022 and EN55024 • Safety compliance: EN 60950 • CE compliance • FCC Part 15 Class A • TBR21 (FXS) • RoHS

Multi-Port ISDN VoIP IAD

SmartNode™ 4630 Series BRI So Gateway Router

The award-winning SmartNode 4630, with up to 5 BRI ports and 8 simultaneous voice channels, is the best way to connect ISDN networks to the world of voice over IP. It enables small offices/remote offices to lower communication costs and provides business-class Internet telephony for demanding ISDN users.



The SmartNode 4630 series are the multi-port ISDN BRI models of the proven market-leading SmartNode VoIP product family. The available 3 and 5 BRI/So port configurations fit the requirements of small and medium enterprises looking for a cost-efficient way to network PBX systems on multiple sites or connect to a public Internet telephony service.

The extra BRI port solves many VoIP network integration problems encountered in real-world installations. The port can synchronize the gateway and provide error-free ISDN data and fax transmissions, and it can be used as a fallback or local-break-out port for optimized call-routing and risk-free operation. With the life-line relay, the port even enables integration of an ISDN emergency terminal powered from the public ISDN.

Like every SmartNode, the 4630 Series models are state-of-the-art VoIP gateways that also provide complete access routing and IP security features. Use the SmartNode as CPE or access router on broadband access, and you can benefit from industry leading Quality of Service (QoS) features ensuring a voice quality unmatched by any IP-phone or gateway on the market.

With the ClearConnect™ dial-backup option, adaptive network monitoring recognizes WAN uplink failures and initiates an ISDN dial-up connection to guarantee interrupt-free voice and data access at all times. If the VoIP link goes down or becomes congested, the SN4630 will switch over to the PSTN and guarantee your call each time.

The SmartNode 4630 is the solution for service providers and network integrators looking for a VoIP product that matches up to ISDN standards in terms of features and quality. SmartNode products provide seamless network integration, continuous trouble-free operation and cost effective deployment to protect your investments for the future.

Application—Network Integration

Whether used as a gateway or as an access router, the SmartNode 4630 provides excellent VoIP and IP QoS features for seamless network integration. All BRI ports are configurable to be TE or NT, you can thus connect your telco line(s) as well as a PBX or ISDN terminals. Terminals are powered with the built-in power supply, eliminating the need for an external box. For business class IP telephony at the tip of your fingers, the SmartNode 4630 is more than just talk!

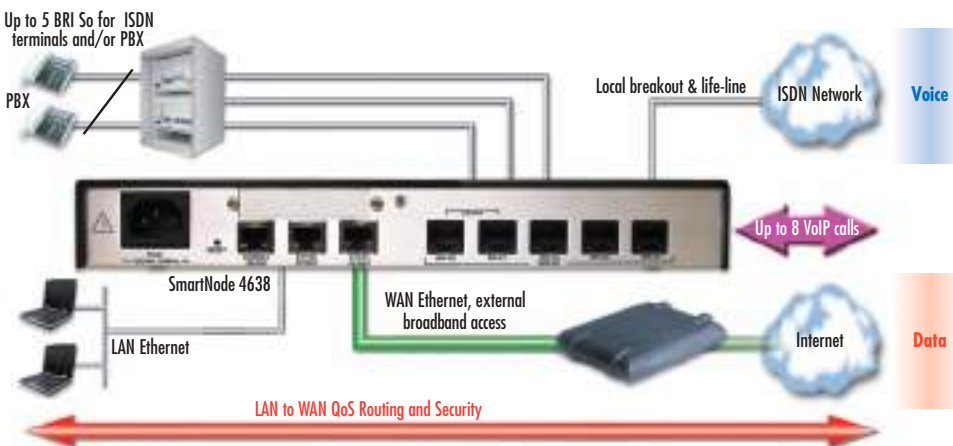

FEATURES & BENEFITS

- ✓ 3/5 Ports Quality ISDN VoIP—3 or 5 ISDN BRI So ports, 4 or 8 low-bandwidth voice or T.38 fax calls. Advanced adaptive traffic management and shaping for maximum voice quality. Voice prioritization and DownStreamQoS™
- ✓ Full Telephony Features—SessionRouter™ allows flexible call routing and numbering plan adaptations, CLIP/CLIR, hold, transfer, and much more.
- ✓ Complete Access Routing—Two 10/100 Ethernet ports with auto MDI-X. Access router with NAT, Firewall, PPPoE, DHCP, DynDNS & VPN with IPsec*
- ✓ Full VoIP protocol support—SIPv2, H.323v4, MGCP/UA, ISDN, DSS1, QSIG*, T.38, fax & modem bypass, DTMF relay.
- ✓ Interoperable for voice & T.38 fax with leading SIP service providers, soft-switch vendors, and Asterisk™ IP-PBX.
- ✓ ClearConnect™ dial-backup option for survivable voice and data connectivity.

ORDERING INFORMATION

SN4634/3BIS/UI: Multi-Port ISDN VoIP IAD—4 VoIP Call; 3 ISDN So Ports; with passthrough relay; UI power

SN4638/5BIS/UI: Multi-Port ISDN VoIP IAD - 8 VoIP Call; 5 ISDN So Ports; with passthrough relay; UI power

SW Options

SNSW-VPN1: License Key for IPsec VPN (DES, 3DES, AES), IKE and Voice-over-VPN

SNSW-QSIG1: License Key for QSIG

SNSW-DB1: Dial-Backup Feature License

Note: Please indicate country specific power cord at time of ordering.

SPECIFICATIONS

- Voice Signaling:** SIPv2 • H.323v4 • MGCP/UA • SIP call transfer, redirect • Overlap or en-bloc dialing • DTMF in-band, out-of-band • Configurable tones
- Call Routing & Services:** Regular expression number matching • Regular expression number manipulation • Least Cost Routing • Number blocking • Short-Dialing • Digit collection • Distribution- and Hunt- Groups
- ISDN:** 3/5 BRI So ports, RJ-45 • NT/TE configurable per port • Built-in line power on each port (total 4W) • DSS1, Q.921, Q.931, NTT-64 • Point-point and point-multipoint • Lifeline Bypass Relay • Optional QSIG support*
- Voice Processing:** G.711m/A-law • G.723.1 (6.4Kbps) • G.729, 729a, 729ab (8Kbps) • G.726 (16, 24, 32, 40 kbps) • G.168 echo cancellation (25ms) • 4/8 simultaneous low-bandwidth voice or T.38 fax calls • Transparent ISDN data • Silence suppression and comfort noise • Adaptive and configurable de-jitter buffer • Configurable packet length
- IP Quality of Service:** Voice priority, DownStreamQoS • Traffic Management, shaping policing • IEEE 802.1p, IEEE 802.1Q, 4096 VLANs (Tag insertion/deletion), TOS, DiffServ Labeling
- Connectivity:** Two 10/100Base-T Ethernet ports • Auto-MDIX • DHCP Client • PPPoE Client (multi-session) • IP Multi-Netting, VLAN, Secondary IP • IPv4, RIPv2, ICMP • Dynamic and static NAT and NAT • ACL Firewall • DNS, DynDNS • DHCP Server • SNMP Client • Optional IPsec VPN (DES, 3DES, AES)
- Management:** Web-based GUI • Fully Documented CLI • Telnet and HTTP access • TFTP configuration up- and download • TFTP firmware upgrade • SNMPv1 agent (MIB II and private MIB) • Built-in diagnostic tools • Secure Auto-Provisioning
- Power & Packaging:** Desktop metal chassis • Dimension: 280/39/157 mm (W/H/D) • Weight: < 600g • Power Consumption < 10W
- Operating Environment:** Op. temp.: 32–104°F (0–40°C) Op. humidity: up to 90% , non condensing
- Compliance:** FCC Part 15 Class A (US EMC) • CE per RTTE 99/5/EC (EMC and LVD) • Safety—EN60950 • TBR-3 (ISDN BRI/So)
- *Requires optional license.

FXS/FXO VoIP IAD with WAN Access

SmartNode™ 4830 Series Analog Gateway Router

The SmartNode 4830 Series is the most cost-effective VoIP IAD with integrated WAN modem in the industry. It lets you connect up to 8 phone lines with best-in-class voice quality and QoS mechanisms for voice, fax and data.



The SmartNode™ 4830 Series IADs let you deliver voice-over-IP over virtually any WAN access link type. The series offers models with combinations of 2 to 8 analog FXS phone ports and 2 or 4 FXO ports. Each model has two Ethernet ports and an integrated WAN access modem—choose from X.21, V.35, T1, E1, G.SHDSL or ADSL2+ to match the given access link with greatest flexibility. Quality

of Service (QoS) features include advanced voice prioritization, traffic management, multiple VLANs and PVCs. DownStreamQoS™ ensures voice without interruptions even over best-effort internet connections. Packet labeling according to 802.1p, TOS and DiffServ enable integration into managed QoS networks.

The SN4830 is the solution for service providers and network integrators looking for the seamless integration of analog phones and PBXs into converged VoIP-Data networks. It ensures easy setup and continuous trouble-free operation and cost effective deployment. The support of the leading VoIP signaling protocols ensures interoperability with third-party equipment and protects your investments for the future.

FEATURES & BENEFITS

- ✓ **Integrated WAN Access**—ADSL2+, G.SHDSL, T1/E1, V.35/X.21 WAN access options. Two 10/100 Ethernet ports. Access router with NAT, Firewall, PPPoE, DHCP, and DynDNS.
- ✓ **Full VoIP Protocol Support**—SIPv2, H.323v4, T.38, fax & modem bypass, G.723, G.729, G.726, G.711, echo cancellation, silence compression, comfort noise, DTMF relay
- ✓ **FXS, FXO, or Combinations**—Up to 8 FXS ports connect to your standard telephone or PBX. 2 or 4 FXO ports allow local PSTN connections. Programmable call routing and switching.
- ✓ **Maximum Voice Quality**—Advanced adaptive traffic management for maximum voice quality. Voice prioritization and DownStreamQoS™.
- ✓ **Management & Provisioning**—Web-based management, SNMP, command line interface, & auto-provisioning for automated configuration & SW upgrades.

SPECIFICATIONS

Capacity: Up to 8 simultaneous VoIP or T.38 fax calls (depending on the model)

Voice Signaling: H.323v4, SIPv2 (B2BUA capable, multi-instance, simultaneous support of multiple registrars and direct IP dialing) • SIP call transfer, redirect • DTMF in-band & out-of-band • All tones programmable (dial, ringing, busy)

Voice Processing: CODEC G.711 a-law/mu-law, G.723, G.729ab, • G.726, G.727, T.38 fax relay (9.6 k, 14.4 k) • G.711 transparent fax and bypass

Call Switching & Services: Virtual interfaces • Regular expression based call routing and number manipulation • Number blocking • Short-dialing • Digit collection, distribution and hunt groups • Transparent line extension • Fallback Routing: Soft fallback to alternative route(s)

FXS Connectivity: 2-wire Loopstart on RJ-11/12 • short haul loop 1.1km @3REN • EuroPOTS (ETSI EG201188) • programmable AC impedance, feeding, ring and on-hook voltage • Caller-ID FSK and ITU V.23/Bell 202 generation

FXO Connectivity: 2-wire Loopstart on RJ-11/12 • Programmable impedance, ring detection, tone detection, disconnect supervision • Caller ID detection

Data Services: Two 10/100 Ethernet ports • Complete IP access router • DHCP Client & server • Packet fragmentation • Static firewall, NAT, NAPT RFC 1631 access control lists • DMZ port • IPSEC.

Quality of Service: Voice priority • DownStreamQoS™ • Traffic management, shaping and policing • IEEE 802.1p, TOS, DiffServ labeling • IEEE 802.1Q, VLAN tag insertion/deletion (simultaneous support of multiple VLANs)

Optional WAN interfaces: X.21/V.35 Frame Relay (8 PVCs); RFC1490, FRF.12 fragmentation; LMI, Q.933D, ANSI 617D, Gang of Four; PPP, PAP, CHAP, LCP, IPCP) • T1/E1 (ITU-T G.703, ANSI T1.403; & AMI, 8BZS, HDB3), PPP • ADSL2+ (Annex A, B, I, J, L, M, U-R2) • G.SHDSL (G.991.2, Annex A, B, F, G, Up to 5.7Mbps, 8 PVCs, QoS)

Management: Web/HTTP, CLI with local console and remote Telnet access • TFTP config & firmware loading • SNMP MIB II and product MIB • Secure mass provisioning for firmware & unit/subscriber config • Built-in diagnostic tools (trace, debug, call generator)

System: CPU Motorola MPC875 @ 66MHz • Memory 32MB SDRAM/8MB Flash • Power 100–240 VAC (50/60 Hz) • Power dissipation 4–12W, model dependent

Environment: Temp.: 0–40°C • Humidity: 5–80% (non condensing)

Compliance: EMC compliance: EN55022 and EN55024 • Safety compliance: EN 60950 • CE compliance • FCC Part 15 Class A • TBR21 (FXS) • RoHS

*x = Interface options: C=V.35 (DB-25F), D=X.21 (DB-15F), K=E1 (RJ-48C), T=T1 (RJ4-8C), G=G.SHDSL (RJ-11), AY=A = ADSL Annex A, AYB = ADSL Annex B WAN options with ADSL 2+ annexes

Application—Remote Office/Branch Office Voice Extension and Access

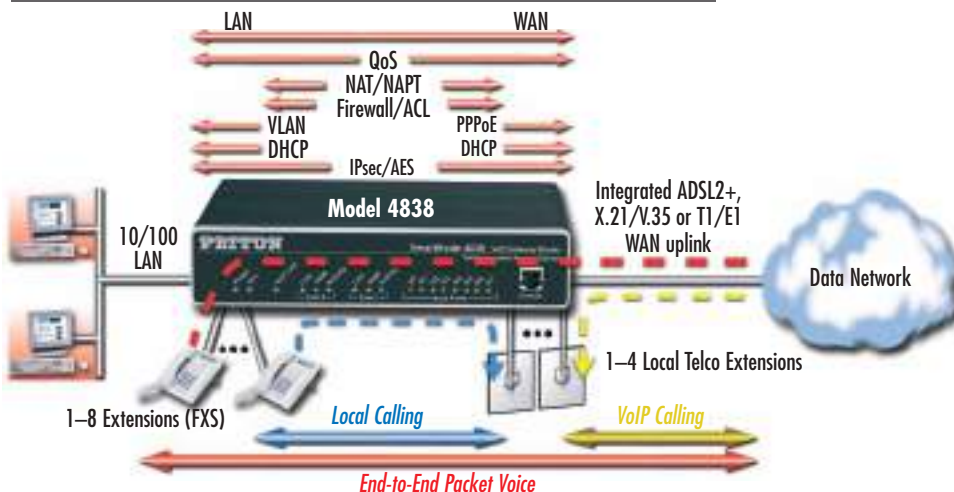

ORDERING INFORMATION

SN4832/JSX*/EUI: 2 Port FXS with integrated WAN

SN4834/JSX*/EUI: 4 Port FXS with integrated WAN

SN4836/JSX*/EUI: 6 Port FXS with integrated WAN

SN4838/JSX*/EUI: 8 Port FXS with integrated WAN

SN4834/2JS2J0X*/EUI: 2 FXS, 2 FXO with integrated WAN

SN4836/4JS2J0X*/EUI: 4 FXS, 2 FXO with integrated WAN

SN4832/J0X*/EUI: 2 FXO with integrated WAN

SN4834/J0X*/EUI: 4 FXO with integrated WAN

SN4838/4JS4J0X*/EUI: 4 FXS, 4 FXO with integrated WAN

Sync Serial Cables

1205-25M/35M: DB-25 male to M/34 male, for V.35 port

1205-25M/35F: DB-25 male to M/34 female, for V.35 port

EMEM216006: DB-15 male to DB-15 male, for X.21 port

ADSL Splitters

5A-1: Single-ort ADSL Splitter

Options & Accessories

SNSW-VPN1: License key for IPsec VPN support (DES, 3DES, AES)

Multi-Port ISDN VoIP IAD with Integrated WAN Access
SmartNode™ 4650 Series BRI So Gateway Router

The SmartNode 4650, with up to 5 BRI ports and 8 simultaneous voice channels, is the best way to connect ISDN networks to the world of voice over IP. Featuring an integrated WAN broadband modem, it delivers converged voice and data services that exceed ISDN standards.



The SmartNode™ 4650 Series are the multi-port ISDN BRI models of the proven market leading SmartNode VoIP product family. The available 3 and 5 BRI/So port configurations fit the requirements of small and medium enterprises looking for a cost-efficient way to network PBX systems on multiple sites or connect to a public Internet telephony service.

The integrated WAN access module enables you to connect the SmartNode 4650 virtually anywhere! Connected to your choice of ADSL2+, G.SHDSL, E1, T1 or V.35/X.21 broadband access, it offers complete access routing, IP secu-

rity features as well as industry leading Quality of Service (QoS). The QoS features ensure a voice quality unmatched by any IP-phone or gateway on the market, and together with IGMP v2/v3, they make the SmartNode 4650 definitely 'triple-play ready'—all in a single box.

The extra BRI port solves many VoIP network integration problems encountered in real-world installations. The port can synchronize the gateway and provide error-free ISDN data and fax transmissions, and it can be used as a fallback or local-break-out port for optimized call-routing and risk-free operation. With the life-line relay, the port even enables integration of an ISDN emergency terminal powered from the public ISDN.

The SmartNode 4650 is the solution for service providers and network integrators looking for a VoIP product that matches up to ISDN standards in terms of features and quality. SmartNode products provide seamless network integration, continuous trouble-free operation and cost effective deployment to protect your investments for the future.

FEATURES & BENEFITS

- ✓ **Integrated WAN Access**—ADSL2+, G.SHDSL.bis, T1/E1, V.35/X.21 WAN access options. Two 10/100 Ethernet ports. Access router with NAT, Firewall, PPPoE, DHCP, & DynDNS.
- ✓ **Outstanding Interoperability**—Proven integration for voice and T.38 fax with leading soft switch vendors; long track record of ISDN interoperability in most countries.
- ✓ **Transparent Telephony Features**—Preserves ISDN features like caller ID and name (CLIP/CLIR), call transfer, hold, waiting, AOC. Supports DID and MSN lines in all major countries as well as complex numbering plan manipulations.
- ✓ **Toll-Quality VoIP**—Advanced traffic management and shaping, combined with Patton's patent-pending DownStream QoS™ enforce uninterrupted toll-quality voice over best-effort networks.
- ✓ **Management & Provisioning**—Web-based management, SNMP, command line interface. Automated provisioning for easy large-scale deployments.
- ✓ **ClearConnect™ dial-backup option for survivable voice and data connectivity.**—With the ClearConnect™ dial-backup option, adaptive network monitoring recognizes WAN uplink failures and initiates an ISDN dial-up connection to guarantee interrupt-free voice and data access at all times. If the link goes down or becomes congested, the SN4650 will switch over to PSTN and guarantee your call each time.

ORDERING INFORMATION

SN4654/3BISx*/UI: 3 BRI/So 4-call VoIP Router, Dual 10/100 Ethernet, Internal 90–250V power

SN4658/5BISx*/UI: 5 BRI/So 8-call VoIP Router, Dual 10/100 Ethernet, Internal 90–250V power

Sync Serial Cables

1205-25M/35M: DB-25 male to M/34 male, for V.35 port

1205-25M/35F: DB-25 male to M/34 female, for V.35 port

EMEM216006: DB-15 male to DB-15 male, for X.21 port

ADSL Splitters

5A-1: Single-port ADSL Splitter

Software options (ordered separately)

SNSW-VPN1: License Key for IPsec VPN (DES, 3DES, AES), IKE and Voice-over-VPN

SNSW-OSIG1: License Key for OSIG

SNSW-DB1: Dial-Backup Feature License

*x = Interface options: C=V.35 (DB-25F), D=X.21 (DB-15F), K=E1 (RJ-48C), T=T1 (RJ4-8C), G=G.SHDSL (RJ-11), AYA = ADSL Annex A, AYB = ADSL Annex B WAN options

SPECIFICATIONS

Capacity: 4 (SN4654 models) or 8 (SN4658 models) simultaneous VoIP or T.38 fax calls

ISDN Connectivity: • 5 ports Euro-ISDN BRI/So RJ-45 • All configurable TE or NT side • Built-in line power • DSS-1, Q.921, Q.931 • Point-point and point-multipoint • Lifeline Bypass Relay • Optional OSIG support
VoIP Signaling: SIPv2 (B2BUA capable, multi-instance, supports registrar and direct IP dialing at the same time) • H.323v4 • MGCP/UA • SIP call transfer, redirect • DTMF in-band & out-of-band • All tones programmable (dial, ringing, busy) • Overlap or en-bloc dialing • Transparent AOC, ECT, CLIP, CLIR, etc • speech, audio & data (Fax Gr 4, UDI 64, • RDI 64);

Voice Processing: CODEC G.711 a-law/mu-law, G.723, G.729ab, • G.726, G.727, T.38 fax relay (9.6 k, 14.4 k) • G.711 transparent fax and bypass

Management: Web/HTTP, CLI with local console and remote Telnet access • TFTP configuration & firmware loading • SNMP MIB II & product MIB • Secure mass provisioning for both firmware and unit/subscriber configuration • Built-in diag tools (trace, debug, call generator)
Data Services: Two 10/100 Ethernet ports • Complete IP access router • DHCP Client & server • Packet fragmentation •

Static firewall, NAT, NAPT RFC 1631 access control lists • DMZ port • IPSEC, IKE, AES/DES/3DES Encryption (optional, hardware accelerated)

Quality of Service: Voice priority • DownStreamQoS™ • Traffic management, shaping and policing • IEEE 802.1p, TOS, DiffServ labeling • IEEE 802.1Q, VLAN tag insertion/deletion (simultaneous support of multiple VLANs and PPPoE sessions)

Optional WAN interfaces: • X.21/V.35 Frame Relay (8 PVCs); RFC1490, FRF.12 fragmentation; LMI, Q.933D, ANSI 617D, Gang of Four; PPP, PAP, CHAP, LCP, IPCP) • T1/E1 (ITU-T G.703, ANSI T1.403; & AMI, B8ZS, HDB3), PPP • ADSL2+ (Annex A, B, I, J, L, M, U-R2) • G.SHDSL (G.991.2, Annex A, B, F, G, Up to 5.7Mbps, 8 PVCs, QoS)
System: CPU Motorola MPC870 @ 66MHz • Memory 32MB SDRAM/8MB Flash • Power 100–240 VAC (50/60 Hz) • Power dissipation 4–12W, model dependent

Environment: Temp.: 0–40°C • Humidity: 5–80% (non condensing)

Compliance: EMC compliance: EN55022 and EN55024 • Safety compliance: EN 60950 • CE compliance • FCC Part 15 Class A • TBR3 (ISDN) • RoHS

Application diagram

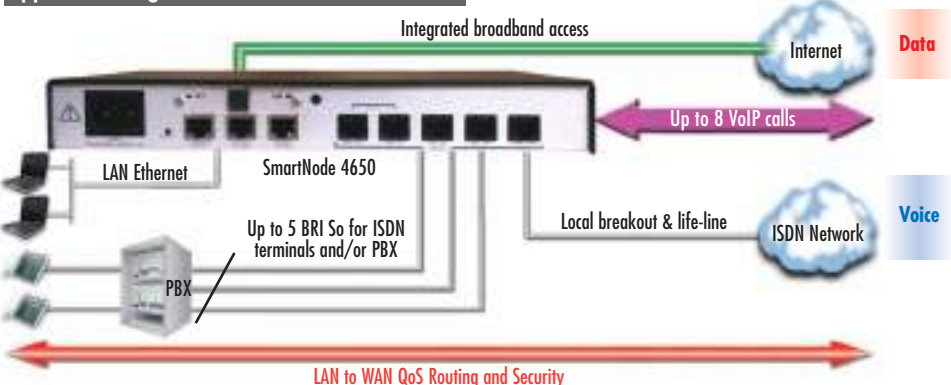

visit us online
www.patton.com

FAST Delivery From Your AUTHORIZED DISTRIBUTOR!



Multi-Port T1/E1 VoIP Integrated Access Device

SmartNode™ 4960

The award-winning SmartNode 4960 integrates with legacy telephony gear to deliver VoIP and data services with QoS and encrypted-voice VPNs. The SmartNode 4960 comes with four T1/E1/PRI ports, two GigE ports, and supports up to 120 simultaneous VoIP calls, making it the ideal choice for low-cost, secure, prioritized communications.



Providing a high-density seamless link between the circuit-switched telephone network and voice-over-IP, the SN4960 is ideal for PBX business trunking or corporate VoIP access. Offering up to four software configurable T1/E1/PRI interfaces the SN4960 connects to any switch, PBX and data network with up to 120 simultaneous calls using SIP, T1, E1 or PRI signaling. The dual gigabit Ethernet ports connect to the network for the highest throughput with its integrated QoS router. With

its built-in CSU/DSU, any T1/E1 port can be selected as a WAN port for a truly integrated voice and data access

Like every SmartNode, the SN4960 delivers toll-quality voice with all industry standard CODECs including low-bandwidth G.723/G.729. Business class services are supported with T.38 fax, fax bypass and modem bypass features.

With the ClearConnect™ dial-backup option, adaptive network monitoring recognizes WAN uplink failures and initiates an ISDN dial-up connection to guarantee interrupt-free voice and data access at all times. If the VoIP link goes down or becomes congested, the SN4960 will switch over to the PSTN and guarantee your call each time.

The SmartNode 4960 is ready for SIP TLS and SRTP through software upgrades. Exclusive DownStreamQoS™ and Voice-over-VPN features give the clear advantage of uninterrupted and secure voice communication for any call today.

SPECIFICATIONS

Voice Connectivity: Up to four software selectable T1/E1/PRI ports • Signalling support (ISDN DSS-1, NI-2, Q.SIG; CAS Robbed bit loop and ground start, E&M, immediate, wink, double wink) • SIPv2 & MGCP/IUA, H.323v4 • ISDN AOC/ECT • ISDN speech, audio & data (Fax Gr 4, UDI 64, • RDI 64); ISDN supplementary services

Voice processing: Codec G.711 a-law/mu-law, G.723, G.729ab, • G.726,

G.727, T.38 fax relay (9.6 k, 14.4 k) • G.711 transparent fax and bypass

Call routing and services: Regular expression matching and manipulation; number blocking; short-dialing; digit collection, distribution and hunt groups.

Data interfaces: Dual 10/100/1000 TX Ethernet Ports • Autosensing • Auto-MDI • Full-duplex

IP Routing: Complete IP access router • DHCP Client & server • Packet frag-

mentation • Static firewall, NAT, NAPT RFC 1631 access control lists

IP Quality of Service: Voice priority, DownStreamQoS • traffic management, shaping policing • IEEE 802.1p, TOS, DiffServ labeling • IEEE 802.1Q, VLAN tag insertion/deletion 4,096

Management: Web/HTTP, CLI with local console & remote Telnet access • TFTP configuration & firmware loading • SNMP MIB II and product MIB • Secure autoprovisioning for firmware & unit/sub-

scriber configuration • Built-in diagnostic tools (trace, debug, call generator)

Environment: Temp: 32–104°F (0–40°C); Humidity: Up to 90% (non condensing)

Power: 100–240 VAC (50/60 Hz)

Power consumption: 15W

Compliance: EMC compliance: EN55022 and EN55024 • Safety compliance: EN 60950 • CE compliance • FCC Part 15 Class A; Part 68; CS-03

FEATURES & BENEFITS

- ✓ Up to 120 simultaneous voice or T.38 fax calls with one to four T1/E1/PRI ports and dual Gigabit Ethernet ports. Use any CODEC or fax on any port, any time.
- ✓ Universal SIP and T.38 support—Softswitch certified signaling support between all T1 RBS CAS, ISDN PRI, Q.SIG, SIP, H.323 and MGCP/IUA protocols.
- ✓ Secure Toll-Quality VoIP—DownStreamQoS and Voice-over-VPN with adaptive traffic management and shaping for maximum voice quality and secure voice communication.
- ✓ Transparent Telephony Features—Handles complex number manipulation and mapping scenarios for most seamless integration with existing infrastructure, CLIP, CLIR, hold, transfer and much more.
- ✓ Management & Provisioning—Web-based management, SNMP, command line interface. Automated provisioning for easy large-scale deployments.
- ✓ ClearConnect™ dial-backup option for survivable voice and data connectivity.

ORDERING INFORMATION

SN4960/1E15V/UI: SmartNode Hi-Cap 1 T1/E1/PRI VoIP IAD, 2x GigEthernet, UI power, 15 VoIP Channels, upgradeable to 30 calls.

SN4960/1E24V/UI: SmartNode Hi-Cap 1 T1/E1/PRI VoIP IAD, 2x GigEthernet, UI power, 24 VoIP Channels, upgradeable to 30 calls.

SN4960/1E30V/UI: SmartNode Hi-Cap 1 T1/E1/PRI VoIP IAD, 2x GigEthernet, UI power, 30 VoIP Channels, non-upgradeable.

SN4960/4E15V/UI: SmartNode Hi-Cap 4 T1/E1/PRI VoIP IAD, 2x GigEthernet, UI power, 15 VoIP channels, field upgradeable to a max of 60 channels.

SN4960/4E24V/UI: SmartNode Hi-Cap 4 T1/E1/PRI VoIP IAD, 2x GigEthernet, UI power, 24 VoIP channels, field upgradeable to a max of 60 channels.

SN4960/4E30V/UI: SmartNode Hi-Cap 4 T1/E1/PRI VoIP IAD, 2x GigEthernet, UI power, 30 VoIP channels, field upgradeable to a max of 60 channels.

SN4960/4E48V/UI: SmartNode Hi-Cap 4 T1/E1/PRI VoIP IAD, 2x GigEthernet, UI power, 48 VoIP channels, field upgradeable to a max of 60 channels.

SN4960/4E60V/UI: SmartNode Hi-Cap 4 T1/E1/PRI VoIP IAD, 2x GigEthernet, UI power, 60 VoIP channels, non-upgradeable

SN4960/4E96V/UI: SmartNode Hi-Cap 4 T1/E1/PRI VoIP IAD, 2x GigEthernet, UI power, 96 VoIP channels, field upgradeable to a max of 120 channels.

SN4960/4E120V/UI: SmartNode Hi-Cap 4 T1/E1/PRI VoIP IAD, 2x GigEthernet, UI power, 120 VoIP channels.

Options & Accessories

SNSW-49V6: 6 channel Voice Upgrade Key for SN4960 VoIP IADs. Software expansion for additional voice channels.

SNSW-VPN2: Software option for IPsec VPN, including DES/3DES and AES encryption, IKE and Voice-Over-VPN.

SNSW-QSIG2: Support for ISDN Q.SIG.

SNSW-DB2: Dial-Backup Feature License

Remote Office/Branch Office Voice Extension and Access diagram

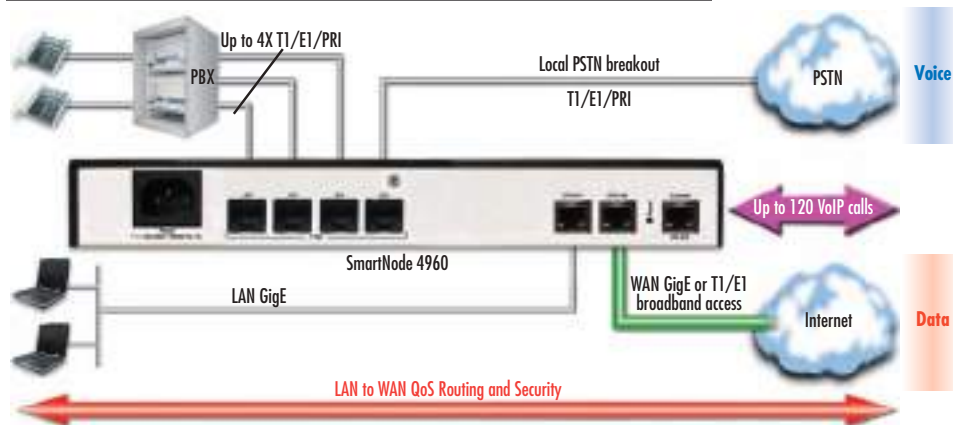

IpChannel Bank Multi-Port FXS & FXO Gateway Router

SmartNode™ 4900 Series

The IpChannel Bank is the perfect VoIP gateway for applications requiring 12 to 32 concurrent analog voice/fax calls within a single redundant solution.



The SmartNode 4900 is the ideal solution for service providers and enterprises requiring high-density analog connections for converged Internet-Telephony. Call centers, multi-tenant-units and PBX/switch extensions can now access the low-cost benefits of packet voice while WAN, data and VPN features permit direct access the IP network with full upstream and DownStream QoS™.

The SN4900 supports 12 to 32 simultaneous VoIP calls over standard two-wire FXS connections. The analog ports are presented on a single Amphenol telco connector for convenient wiring closet connection. Local LAN connectivity is presented via dual 10/100 Ethernet ports. Traffic can be routed out

either port for load-balancing and redundancy. Dual-redundant power supplies protect against equipment down-time.

Seamless and secure network integration with fixed IP, DHCP or PPPoE. Complete access routing features include NAT/NAPT, Firewall, DynDNS and the optional IPSec VPN feature license offer secure data.

Optional WAN uplink modules, available in V.35/X.21, T1/E1, and xDSL options, eliminate the need for extra network termination devices and extra cost.

Quality of Service (QoS) features included advanced voice prioritization and traffic management. DownStreamQoS™ ensures voice without interruptions even over best-effort internet connections. Packet labeling according to 802.1p, TOS and DiffServ enable integration into managed QoS networks.

Integrated GUI and Command Line, front panel status and call load indicators and a full suite of management interfaces ensure efficient setup, continuous trouble-free operation and cost-effective deployment.

FEATURES & BENEFITS

- ✓ 12, 16, 24 or 32 FXS or FXO ports—Simultaneous voice or fax calls on all ports. Advanced local call switching.
- ✓ Full SIP and T.38 support—Supports the complete range of industry standard VoIP: SIP, H.323, T.38 fax, fax and modem bypass, DTMF relay. Codecs G.729, G.723 etc.
- ✓ Secure Toll-Quality VoIP—DownStreamQoS and Voice-over-VPN with adaptive traffic management and shaping for maximum voice quality and secure voice communication.
- ✓ Complete Access Routing—Two 10/100 Ethernet ports with auto MDI-X. Access router with NAT, Firewall, PPPoE, DHCP, DynDNS, multiple VLANs & VPN with IPSec*.
- ✓ Optional Integrated WAN uplink—Choose from V.35, X.21, T1/E1, ADSL and G.SHDSL data interfaces in addition to the two Ethernet ports.
- ✓ Outstanding Interoperability—Interoperable for voice and T.38 fax with leading SIP service providers, soft-switch vendors and Asterisk™ IP-PBX.
- ✓ Use FXS models for call center applications and FXO for PSTN analog trunking.

Typical applications



ORDERING INFORMATION

- SN4912/JS*/RUI: IpChannel Bank 12 Port FXS
- SN4916/JS*/RUI: IpChannel Bank 16 Port FXS
- SN4924/JS*/RUI: IpChannel Bank 24 Port FXS
- SN4932/JS*/RUI: IpChannel Bank 32 Port FXS
- SN4912/JSX*/RUI: IpChannel Bank 12 Port FXS WAN Uplink
- SN4916/JSX*/RUI: IpChannel Bank 16 Port FXS WAN Uplink
- SN4924/JSX*/RUI: IpChannel Bank 24 Port FXS WAN Uplink
- SN4932/JSX*/RUI: IpChannel Bank 32 Port FXS WAN Uplink

Options & Accessories

SNSW-VPN1: License Key for IPSec VPN support (DES, 3DES, AES)

- SN4912/JO*/RUI: IpChannel Bank 12 Port FXO
- SN4916/JO*/RUI: IpChannel Bank 16 Port FXO
- SN4924/JO*/RUI: IpChannel Bank 24 Port FXO
- SN4932/JO*/RUI: IpChannel Bank 32 Port FXO
- SN4912/JOX*/RUI: IpChannel Bank 12 Port FXO, WAN uplink
- SN4916/JOX*/RUI: IpChannel Bank 16 Port FXO, WAN uplink
- SN4924/JOX*/RUI: IpChannel Bank 24 Port FXO, WAN uplink
- SN4932/JOX*/RUI: IpChannel Bank 32 Port FXO, WAN uplink

Note: 48VDC or split 48VDC/0V power options available.

*X = Interface options: C=V.35, D=X.21, K=E1, T=T1, F=Fiber, AX=ADSL, G=G.SHDSL

SPECIFICATIONS

Capacity: 12, 16, 24, 32 simultaneous VoIP calls

Voice Signaling: SIPv2 H.323v4 (simultaneously with B2BUA capability) • SIP call transfer, redirect • DTMF in-band & out-of-band • All tones programmable (dial, ringing, busy)

Voice Processing: CODEC G.711 a-law/mu-law, G.723, G.729ab, • G.726, G.727, T.38 fax relay (9.6 k, 14.4 k) • G.711 transparent fax and bypass

Call Switching and Services: Regular expression based call routing and number manipulation • Number blocking • Short-dialing • Digit collection, distribution and hunt groups • Transparent line extension

FXS Connectivity: 2-wire Loopstart on 50pin (12 to 24 channels) or 64pin (32 channels) Telco connector • short haul loop 1.1km @3REN • EuroPOTS (ETSI EG201188) • programmable AC impedance, feeding, ring and on-hook voltage • Caller-ID FSK and ITU V.23/Bell 202 generation

FXO Connectivity: 2-wire Loopstart on 50pin (12 to 24 channels) or 64pin (32 channels) Telco connector • Programmable impedance, ring detection, tone detection, disconnect supervision • Caller ID detection

Data Services: Two 10/100 Ethernet ports • Complete IP access router • DHCP Client & server • Packet fragmentation • Static firewall, NAT, NAPT RFC 1631 access control lists • DMZ port

Quality of Service: Voice priority • DownStreamQoS™ • Traffic management, shaping and policing • IEEE 802.1p, TOS, DiffServ labeling • IEEE 802.1Q, VLAN tag insertion/deletion 4,096

Optional WAN interfaces: X.21/V.35 Frame Relay (8 PVCs); RFC1490, FRF12 fragmentation; LMI, Q.933D, ANSI 617D, Gang of Four; PPP, PAP, CHAP, LCP, IPCP) • T1/E1 (ITU-T G.703, ANSI T1.403; & AMI, B8ZS, HDB3) • ADSL2+ (Annex A, B, I, J, I, M, U-R2) • G.SHDSL (G.991.2, Annex A, B, F, G, Up to 5.7Mbps, 8 PVCs, QoS)

Management: Web/HTTP, CLI with local console and remote Telnet access • TFTP configuration & firmware loading • SNMP MIB II and product MIB • Secure auto-provisioning for both firmware and unit/subscriber configuration • Built-in diagnostic tools (trace, debug, call generator)

System: CPU Motorola MPC875 @ 133 MHz • Memory 32MB SDRAM/8MB Flash

Power: 100–240 VAC (50/60 Hz) • Power dissipation: > 22W (60W max, model SN4932/JS/RUI)

Environment: Temp.: 0–40°C • Humidity: 5–80% (non condensing)

Compliance: EMC compliance: EN55022 and EN55024 • Safety compliance: EN 50950 • CE compliance • FCC Part 15 Class A

4-Slot Modular Router

SmartNode™ 2400

Combining a real-time QoS IP router, Voice-over-Packet Gateway, and ToIP circuit switching, the SmartNode 2400 Series VoIP Media Routers & Gateways are ideal for multi-service carrier access and corporate PSTN networking for up to 120 simultaneous calls.



The SmartNode 2400 Series provides a high density, seamless link between the circuit-switched telephone network and Voice-over-IP. Ideal for multi-service carrier and corporate PSTN access, the SmartNode 2400 Series takes 120 calls from voice-to-packet. With dual 10/100 Ethernet ports and four voice interface slots, the SmartNode 2400 connects to any switch, PBX, or data network.

The SmartNode delivers VoIP that has the clarity of toll-quality voice. Multiple user-defined G.711 and G.726 voice CODECs are included, as well as G.723 and G.729ab for low bandwidth voice. T.38 FoIP, fax bypass, and modem bypass capabilities ensure that the SmartNode will seamlessly connect to all voice and data services. QoS ensures optimal voice performance through traffic classification and prioritization.

Patton's exclusive Telephony-over-IP™ (ToIP™) programmable circuit switching delivers service transparency and flexible PSTN integration. With ToIP any BRI, T1/E1 PRI, or FXS port can connect to any telephone or media gateway port.

FEATURES & BENEFITS

- ✓ Supports up to 120 simultaneous calls from any combination of voice signaling including T1 RBS, T1/E1 PRI, BRI, and FXS.
- ✓ T1/E1, BRI, & FXS Voice Interface Cards—Use any combination of voice interfaces for connection to any telephone, switch, or service provider.
- ✓ Expansion slots for ISDN, T1, E1, and FXS interface cards for voice processing features
- ✓ Voice VPNsReal-time quality of service (TOS, Diffserv, and IEEE 802.1p/Q)
- ✓ Simultaneously compresses up to 120 ISDN voice calls over the same IP link

ORDERING INFORMATION

Note: Select up to four ISDN, T1, E1, and FXS interface cards from page 31 to configure the SmartNode Gateway Router to meet your requirements.

SN2400/OVIL/UI: Gateway Router QoS ToIP, Internal UI (90–260 VAC) power; no VoIP modules

Options & Accessories

SNSW-VPN2: License Key for IPSec VPN support (DES, 3DES, AES)

Application—Shared-Switch Access

To take advantage of emerging technologies and the changing regulatory environments, network service providers are providing new services which can be integrated within the enterprise to reduce costs and improve service. Deployed as a trunk gateway, the SmartNode is the seamless link between the PSTN

and VoIP access. Subscribers now access new carrier services without incurring charges from the incumbent carrier.

In enterprise networks, the SmartNode integrates telephony and IP data communications for best use of bandwidth, improved office-to-office communication, and reduced network costs.

Instead of installing a separate PBX in a remote office, the SmartNode is able to provide transparent extension of PBX phones. The extension can be managed centrally and benefit from services such as calling groups, least cost routing, and call forwarding.



SPECIFICATIONS

Data Connectivity: 2 10/100Base-T Ethernet, RJ-45

Voice Signalling: Euro ISDN EDSS-1/ETSI BRI/NET3 (ETS 300 012-1 (ITU-T I.430); ETS 300 402-1 (ITU-T Q.921); ETS 300 403-1/2 (ITU-T Q.931); ETS 300 102-1 (ITU-T Q.931)) • Q-SIG (PSS-1) (ECMA-143; ETSI and ISO/ECMA channel numbering) • SIP and MGCP • H.323v3 (RAS, H.225, H.245; Fast-connect, early H.245; Gatekeeper autodiscovery; Alias

registration; Overlap sending; Empty capability set (call transfer, hold); H.323v1 call transfer, hold) • ECS support • ISDN over IP (ISoIP) • H.323 GW and GK compatible • H.323 Annex M3 • ISDN/Q-SIG feature tunnelling • ISDN speech, audio and data (Fax Gr 4, UDI 64, RDI 64) • ISDN supplementary services

Voice Routing—Session Router™: Local switching • Interface huntgroups • ISDN broadcast message

routing • Routing Criteria (Interface; Calling/called party number; Time of day, day of week, date; ISDN bearer capability) • Number manipulation functions (Replace numbers; Add/remove digits) • Multiple remote gateways • PLAR

IP Routing: IPv4 router • RIPv1, v2 (RFC 1058 and 2453) • Programmable static routes • ICMP redirect (RFC 792) • DHCP client/server • Packet fragmenta-

tion • Static Firewall (NAT/PAT/NAPT (RFC 1631); Access control lists)

IP Quality of Services: WFO/Fixed Rate/Priority Queuing/Flow-split scheduler • Combination of QoS schemes with configurable burst • DiffServe/ToS set or queue per header bits • Packet Policing discards excess traffic • 802.1p/Q VLAN support with 4096 IDs • Traffic classification

Management: Industry standard CLI

• Local console (RS-232, RJ-45) and remote Telnet access • TFTP configuration down- and upload • TFTP firmware download • SNMP v1 agent (MIB II and private MIB) • Built-in diagnostic tools (trace, debug) • Java™ Applet • HPOV Integration with NNM

Operating Environment: Op. temperature: 0–40°C
Op. humidity: 5–80% (non-condensing)

System: CPU Motorola MPC750 at 333 MHz (Memory 32MB SDRAM (160MB max.)/16 MB Flash) • Power: 100–240 VAC (50/60 Hz) • Power dissipation 30W (fully loaded)

Compliance: EMC compliance: EN55022 and EN55024 • Safety compliance: EN 50950 • CE compliance • FCC Part 15 Class A

30-Channel E1 Module for ISDN PRI

IC-E1V Interface Card for SmartNode™ 2400



ORDERING INFORMATION

SN-IC-E1V: 30-channel E1 gateway interface card for ISDN PRI

SN-IC-E1V-0: E1 Gateway interface card for ISDN PRI (circuit switching only)

SN-IC-E1V-15: 15-channel E1 gateway interface card for ISDN PRI

FEATURES & BENEFITS

- ✓ IC-E1V provides one PRI E1 port to support 30 VoIP calls. For mounting in the SN2400 expansion slots.
- ✓ IC-E1V-0 is an E1 gateway interface card for ISDN PRI-circuit switching only.
- ✓ IC-E1V-15 is a 15-channel gateway interface card with one ISDN PRI/S2m port.

23-Channel T1 Module for ISDN PRI

IC-T1V Interface Card for SmartNode™ 2400



ORDERING INFORMATION

SN-IC-T1V: 23-channel T1 gateway interface card for ISDN PRI

SN-IC-T1V-0: T1 Gateway interface card for ISDN PRI (circuit switching only)

SN-IC-T1V-15: 15-channel T1 gateway interface card for ISDN PRI

FEATURES & BENEFITS

- ✓ IC-T1V provides one PRI T1 port to support 30 VoIP calls. For mounting in the SN2400 expansion slots.
- ✓ IC-T1V-0 is an T1 gateway interface card for ISDN PRI-circuit switching only.
- ✓ IC-T1V-15 is a 15-channel gateway interface card with one ISDN PRI/S2m port.

8-Channel Module Provides 4 ISDN BRI Interfaces

IC-4BRV Interface Card for SmartNode™ 2400



ORDERING INFORMATION

SN-IC4BRV-8V: 4 x ISDN BRI/So VoIP, NT/TE configurable, 8 DSP VoIP channels

SN-IC4BRV-8VR: 4 x ISDN BRI/So VoIP, NT/TE configurable, 8 DSP VoIP channels

FEATURES & BENEFITS

- ✓ IC-4BRV provides four BRI/SO ISDN ports to support 8 VoIP calls. For mounting in the SN2400 expansion slots.
- ✓ IC-4BRV-8V is an 8-channel gateway interface card for ISDN BRI/SO.
- ✓ IC-4BRV-8VR is an 8-channel gateway interface card for ISDN BRI/SO with hardware bypass (emergency) relay.

4-Channel Module Provides 4 Analog Phone Ports

IC-4FXS Interface Card for SmartNode™ 2400



ORDERING INFORMATION

SN-IC4FXS: 4 x FXS VoIP, 4 DSP VoIP channels Requires PM-4XV-int for FXS power

FEATURES & BENEFITS

- ✓ IC-4FXS provides 4 analog FXS ports and connects to the SmartNode base unit through a PCI packet and PCM circuit interface. The IC-4FXS supports up to 4 simultaneous voice or fax calls.

I'm Natalie, Patton's Inside Sales Manager, US & Canada. Call me at +1 301.975.1000 when you want to purchase Patton products or if you have questions about our products. You can also send e-mail to sales@patton.com.

IP-PBX

SipXNano-15 & SipXNano-30

Patton's SipXNano IP-PBX enables small enterprises to access large enterprise PBX features and becomes the first to realize the benefits of VoIP.



The SIPxNano is a full function IP-PBX tailored to meet the needs of small to medium enterprises and branch offices. It provides the features of a traditional PBX with the benefits of VoIP such as soft clients and voicemail to e-mail integration. The SIPxNano supports up to 30 concurrent users and comes with common PBX/Key System features such as an auto-attendant, configurable call routing, music on hold, call-forwarding, music on park, hunt groups, and much more.

The web-based administrative interface permits quick and easy configuration of dialing plans, auto attendants and other PBX features. Office users of the SIPxNano IP-PBX benefit the most from the voicemail to e-mail integration. An

easy to use web page is available to create and manage personal voicemail folders. Menu options facilitate the setup of e-mail notification and even e-mail delivery of the message in easy-to-open .wav file format. Multiple greetings can be recorded and then activated via a drop down box.

Enterprises operating in multiple locations can leverage their existing data intranet/VPN investment to extend features of the headquarters IP-PBX to all locations and telecommuters. Every employee can be reached via a 3-digit extension by a simple web page configuration of the dialing plan. Intra-enterprise long-distance phones bills drop to zero by using the VPN. At the same time, additional savings can be achieved both by reducing the number of local PSTN connections, as well as by leveraging the remaining local PSTN connections in remote offices to effect a least cost routing of long distance calls to the remote office area code and thereby performing a long distance toll by-pass.

When combined with a Patton SmartNode or SmartLink device, the SIPxNano IP-PBX provides VoIP services to analog phones, faxes, and legacy PBX systems that are not able to support newer VoIP technologies.

FEATURES & BENEFITS

- ✓ Full Function Enterprise PBX—Complete call control, voicemail and administrative systems
- ✓ Drives Intra-Enterprise Calling Costs Down—All voice traffic is transported as data across your data connection on the enterprise IP network
- ✓ Geographically Unified Calling Features —All employees with an Internet connection can have access to the same PBX features from any location
- ✓ Easy to Use System Configuration—Full system and user administration via web interface
- ✓ Voicemail and Email Integration—Sends your voicemail to your email
- ✓ Web-Based Self-Administration—Users can specify call forwarding, call routing and voicemail preferences thru the web interface

SPECIFICATIONS*

Protocol: IETF SIP RFC3261—SIP
Call Routing/Call Processing: Automatic call route selection • User and Administrator web-based configuration • Call admission control • Digitmap-based call setup control • Dynamic call forwarding • Hotline/Ring down • Hunt groups • Message waiting indication • Multi-site/Multi-location • Multi-station appearance • Local/Remote stations • Outbound Call blocking/Toll restriction • Out-of-band DTMF signaling • Phone number to SIP address alias facility • System security • Web services APIs for configuration server • User forwarding through GUI • Backup configuration via the GUI • Emergency routing • Attendant console • Direct call pick-up • Call Park/Retrieve with music on hold
Media Server: HTTPS-based message storage • Customizable voicemail greetings • Operator (zero out) • Login to VM via user greeting • User distribution lists • Change VM password through GUI

Auto Attendant: Alpha-dialed number confirmation • Customizable main greeting • Dial by extension • Dial by Name • Operator (zero out)
Interactive Voice Response (IVR): Customizable top-level IVR choices
CPU: Onboard VIA EDEN N Nano processor (1.3 GHz Pentium equivalent)
RAM: 256Mb DDR266
I/O Interface: LPT • RS-232 • PS/2 Keyboard • PS/2 Mouse • USB 2.0 ports, Qty: 2
Operating System: Linux
Power supply: Universal 100–240 VAC
Dimensions: 6.7 x 4.9 x 2.3 in. (170 x 124 x 58 mm) Aluminum case
Weight: 940g
Operating Humidity: 0–90% relative humidity, non-condensing
Operating Temp.: 32–140°F (0–60°C)

* Hardware specifications subject to change without notice.

ORDERING INFORMATION

SIPxNano-15/E: SmartLink IP-PBX NanoServer & 15 concurrent user license with 1-year software maintenance; AC UI power

SIPxNano-30/E: SmartLink IP-PBX NanoServer & 30 concurrent user license with 1-year software maintenance; AC UI power

SL4250-75: SmartLink IP-PBX rack mount server w/RAID1 & 75 user license with 1-year software maintenance

SL4250-125: SmartLink IP-PBX rack mount server w/RAID1 & 125 user license with 1-year software maintenance

SL4250-250: SmartLink IP-PBX rack mount server w/RAID1 & 250 user license with 1-year software maintenance

Application diagram

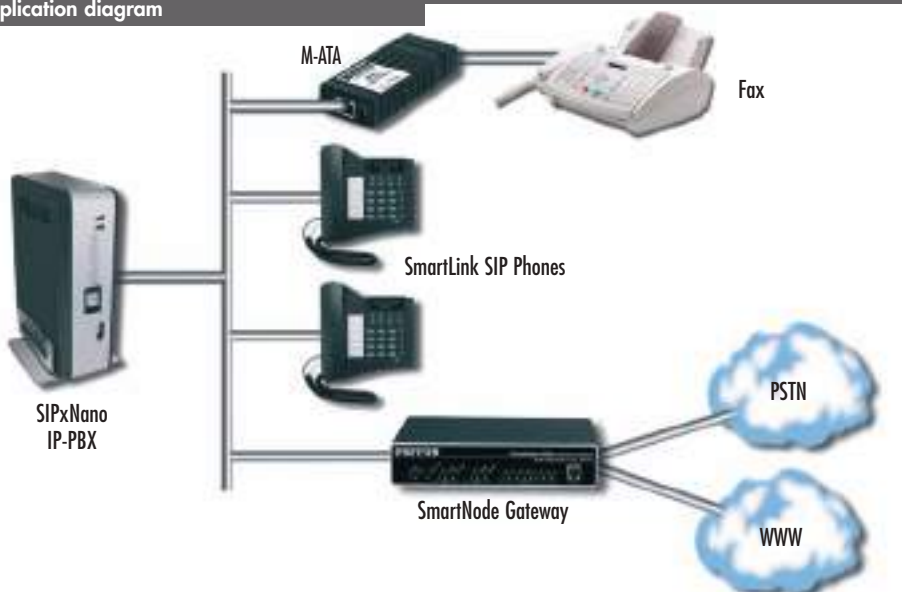

Successful VoIP Starts With a SmartNode™ ...



Introducing the **IpChannel Bank™**

Whether you're connecting hundreds of handsets, transporting a termination, or sharing a PRI, nothing works like Patton's SmartNode™ 4900 Series IpChannel Bank.

The IpChannel Bank is the perfect SIP gateway for applications requiring 12 to 32 con-

current analog voice/fax calls within a single redundant solution.

With easy setup and third-party interoperability on a proven platform, the SmartNode 4900 Series IpChannel Bank is *VoIP that works.*

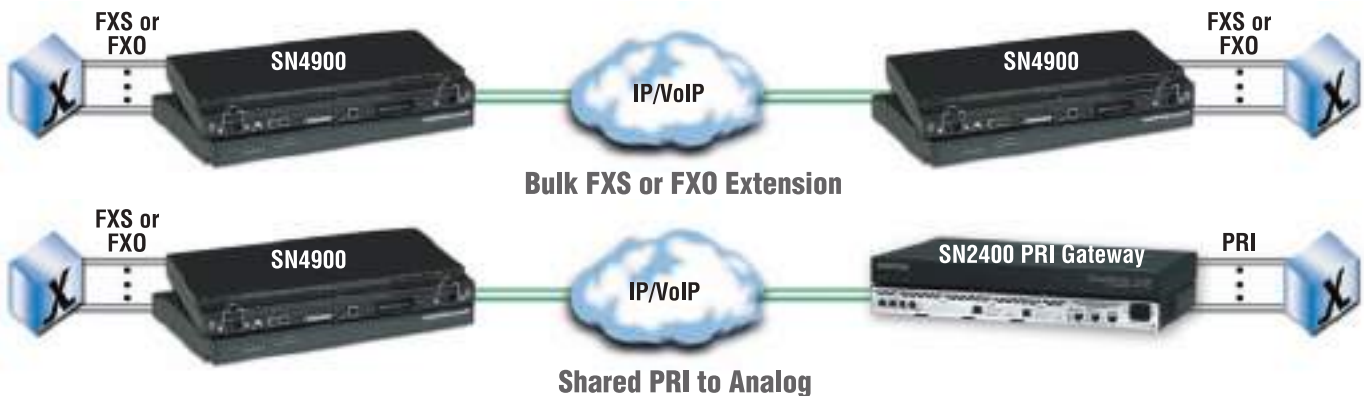

Get your **FREE "VoIP Product Guide"**

The VoIP Product Guide includes a broad range of SmartNode VoIP solutions offering up to 120 ports of IP connectivity.

Call today: **+1 301.975.1000**

or Email: **sales@patton.com**

www.patton.com



7622 Rickenbacker Drive
Gaithersburg, MD 20879

+1 301.975.1000

www.patton.com

sales@patton.com

SIP Telephones

SmartLink™ 4050 Series

Move to the world of VoIP telephony with these full-function SIP phones.



SL4050/2

Smartlink 4050 IP Phones are full-featured VoIP telephones that provide a rich set of end user calling features and allow full integration with intranet IP-PBXs and Internet Telephony Service providers. With speaker phone, multi-line support, one touch dialing, local conferencing capabilities, and 200 number local phone directory, the SL4050 phones are suitable for the corporate desktop or the home/home office.

Full support is provided for local configuration of call handling for busy, call forward and conditional call forward.

The SmartLink 4050s can be easily installed and configured through a local web interface for individual installations. For enterprises or service providers in need of large scale deployments, the SIP phones feature automatic firmware and configuration and phone directory download from a central configuration server for plug-and-play setup.

FEATURES & BENEFITS

- ✓ Full VoIP SIP feature set
- ✓ Rich set of local calling features including conditional call forwarding, call park, and group pickup
- ✓ Dual Ethernet ports to minimize cabling needs
- ✓ Up to four SIP user accounts
- ✓ Up to 10 lines or one-touch speed dial buttons
- ✓ Local Web configuration or remote configuration download
- ✓ Local conferencing
- ✓ Call transfer
- ✓ Message waiting indicator

ORDERING INFORMATION

SL4050/2/EUI/K: 2 Line VoIP SIP Phone with 2X 10/100Base-TX, EU power, North American power cord. Color: Black

SN4050/2/EUI/A: 2 Line VoIP SIP Phone with 2X 10/100Base-TX, EU power, European power cord. Color: Black

SL4050/2/E: 2 Line VoIP SIP Phone with 2X 10/100Base-TX, EU power, Order cord or PoE independently power cord. Color: Black

SL4050/10/EUI/K: 10 Line VoIP SIP Phone with 2X 10/100Base-TX, EU power, North American power cord. Color: White

SL4050/10/EUI/A: 10 Line VoIP SIP Phone with 2X 10/100Base-TX, EU power, European power cord. Color: White

SL4050/10/E: 10 Line VoIP SIP Phone with 2X 10/100Base-TX, EU power, Order cord or PoE independently power cord Color: White

Options & Accessories for SN4050/2 & SN4050/10

PO805: EU 110—240V to 5V power transformer—Order country-specific power cord

O805-INF-POE-5: IEEE 802.3af Power over Ethernet (PoE) splitter—5VDC output

SPECIFICATIONS

Protocol: IETF SIP RFC3261

Network Interface: RJ45 x 2, 10/100Base-T

Call Features: Call transfer (unattended/blind & announced) • Call forward (busy/no answer/unconditional) • anonymous call blocking • out-of-band DTMF (RFC 2833) • message waiting indicator • call park/pickup (support SIP required) • group pickup (Support SIP server required)

Voice Codec: G.711µ-law • G.711a-law • G.723.1 (5.3k) • G.723.1 (6.3k) • G.729a/b

SIP Server Support: Registrar Server (setting from web) • Outbound Proxy (setting from web)

IP Assignment: Static IP • DHCP • PPPoE

Security: HTTP 1.1 basic/digest • authentication for Web setup • MD5 for SIP authentication (RFC 2069/ RFC 2617)

QoS: ToS field • IEEE 802.1q VLAN • Tone • DTMF—(inband, out of band, SIP info) • 4 selectable ring tones • ring back tone (local & remote) • dial tone • busy tone

Dial Methods: Direct IP call without SIP registration • dial registered number via SIP server • dial URI from phone book/speed dial

Voice Quality: VAD (voice activity detection) • CNG (comfort noise generation) • AEC (acoustic echo cancellation) • G.168 • jitter buffer

Firmware Upgrade: TFTP • auto/manual provisioning system • NAT Traversal • UPnP • STUN • TCP/IP • IP/TCP/UDP/DHCP/RTP/RTCP • ICMP/HTTP/SNTP/TFTP/DNS

Configuration: Key & LCD configuration • web browser configuration • auto/manual provisioning system

Compliance: FCC Part 15 Class B • CE Class B • VCCI Class B • EN60950

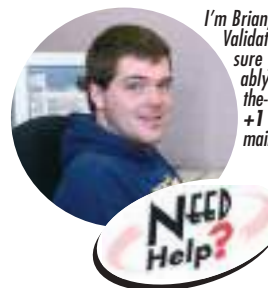
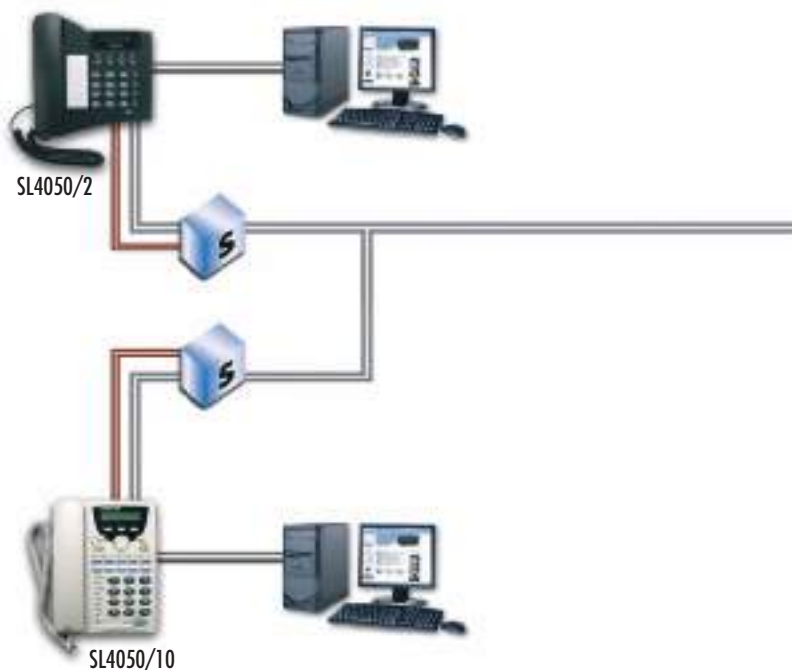

I'm Brian, one of Patton's Product Validation Engineers who makes sure your VoIP product works reliably. To buy one of these state-of-the-art devices, call +1 301.975.1000 or send e-mail to sales@patton.com.

IP-PBX

SmartLink™ 4250 IP PBX

The Patton Smartlink 4250 IP PBX provides complete PBX services to VoIP equipment within centralized or decentralized enterprises.



The Patton IP PBX, the SmartNode family of analog and PSTN trunk gateways, and VoIP SIP phones are the elements of an enterprise PBX solution that can be purchased as complete turnkey system or as individual elements.

The IP PBX package is designed to serve as a replacement or augmentation to traditional telephony PBX systems while providing access to enhanced telephony features that are only available through VoIP. Single IP PBX systems are targeted for use in the private enterprise networks of up to 150 – 200 employees. Multiple systems can be implemented in larger organizations to provide seamless calling between systems or sites.



Web based administrative and user interfaces allow for quick and easy adjustment of calling preferences.

Enterprises operating in multiple locations can leverage their existing data intranet /VPN investment to extend the headquarters IP PBX all locations and telecommuters. Every employee can be reach on a simple 3 digit extension and all the features of the IP PBX are available to all employees. Intra-enterprise long-distance phones bills drop to zero while increasing organizational productivity. Additional cost savings can be achieved through downsizing of the local PSTN connection(s) and/or leveraging the local connections to implementing least cost telephony routing.

QoS capabilities on all elements of the Patton IP voice solution ensures that voice traffic can be given a higher priority than data within your network

The IP PBX includes a robust Voice mail system that allows users to retrieve their voice mails from any phone or interface with a browser. User preferences on the web interface allow each user to set voice message delivery options including delivery of voicemails to email.

The Smartlink 4250 is based on the VoIP industry standard SIP protocol (IETF RFC 3261) and provides compete SIP registration, subscription and notification services to any SIP capable end point. APIs in the software allow for easy integration of other 3rd party SIP based applications.

When partnered with a Patton Smartnode product, the Patton 4250 IP PBX can provide VoIP services to analog phones, faxes and legacy PBX systems that are not prepared to support newer VoIP technologies. Patton's ability to link voice technologies of the past with today's VoIP technologies allows your enterprise to cost effectively move forward.

FEATURES & BENEFITS

- ✓ Full Enterprise PBX, Call Control and Routing functions
- ✓ Uniquely leverages the unique functionality of Patton's Routers and Gateways & SIP Phones
- ✓ Standards-based implementation of the IETF Session Initiation Protocol (SIP) standard for end-to-end signaling.
- ✓ Simple to install with a browser-based configuration and management
- ✓ Easy to use with browser-based user interfaces
- ✓ Unprecedented customizable PBX system and unified messaging features
- ✓ Email notification and delivery of voice mail
- ✓ Scalable up to hundreds users—from 50 to 1000s
- ✓ Adaptable to a variety of telephony environments
- ✓ Modular architecture allows distributed network integration for multi-site, multi-station and multi-location support
- ✓ High reliability, backup and load balancing
- ✓ Highly manageable, productive, and secure
- ✓ Fully supported by Patton



VoIP Auto-Provisioning System (VAPS)

Provides centralized configuration and firmware control for large implementations of Patton VoIP Products



Service provider or enterprises with large deployments of Patton VoIP equipment require a way to centrally manage and control deployment of end user configurations and firmware. Configuration of individual devices via web interfaces is not a practical option for customers with a large installed base of end users. Patton's VAPS is a centralized provisioning and configuration tool that enables large scale roll-out, configuration, and firmware deployment of the Patton VoIP products at a device, group or network wide level.

Using web configuration screens similar to the web interface presented by the actual device, properly authenticated network operations personnel can review and adjust device configuration parameters. Changes that have been set to the VAPS database will be deployed to the selected devices the next time the device reloads or checks-in with VAPS server. Patton Smartnode and SmartLink products will check in with the VAPS server on a configuration defined interval.

The VAPS log tracks each VoIP device's check-in with the VAPS and what activities were performed. Network operators can quickly tell which devices received new configurations and new firmware.

To provide maximum connectivity to diverse end user environments, configuration and firmware is transmitted to and from VAPS using HTTP. Secure HTTPS is supported with the installation of an SSL public certificate on the VAPS server. Smartnode products offer the additional option of distributing configuration information using TFTP.

FEATURES & BENEFITS

- ✓ Centrally manages 100s–1,000s of Patton VoIP devices— Individual, group level or network-wide device configuration and firmware control
- ✓ Easy integration with existing Network Management Systems— Link to the VAPS database using ODBC
- ✓ Open standard HTTP or HTTPS-based data transfer— Provides maximum connectivity to end user devices located behind firewalls
- ✓ Eliminates the need manage to each device individually— device check-in deploys new firmware and software groups or all devices managed by VAPS
- ✓ Full integration with SmartLink and SmartNode products; Track device check-ins and upgrades— VAPS system log tracks firmware, configuration and check-in activity by device
- ✓ **VAPS Requirements:** Windows XP Server (XP Pro can be substituted for XP Server if fewer than 8 sessions will be served) with MS-SQL or Linux with MYSQL DB

ORDERING INFORMATION

Call for a custom quote for your deployment.

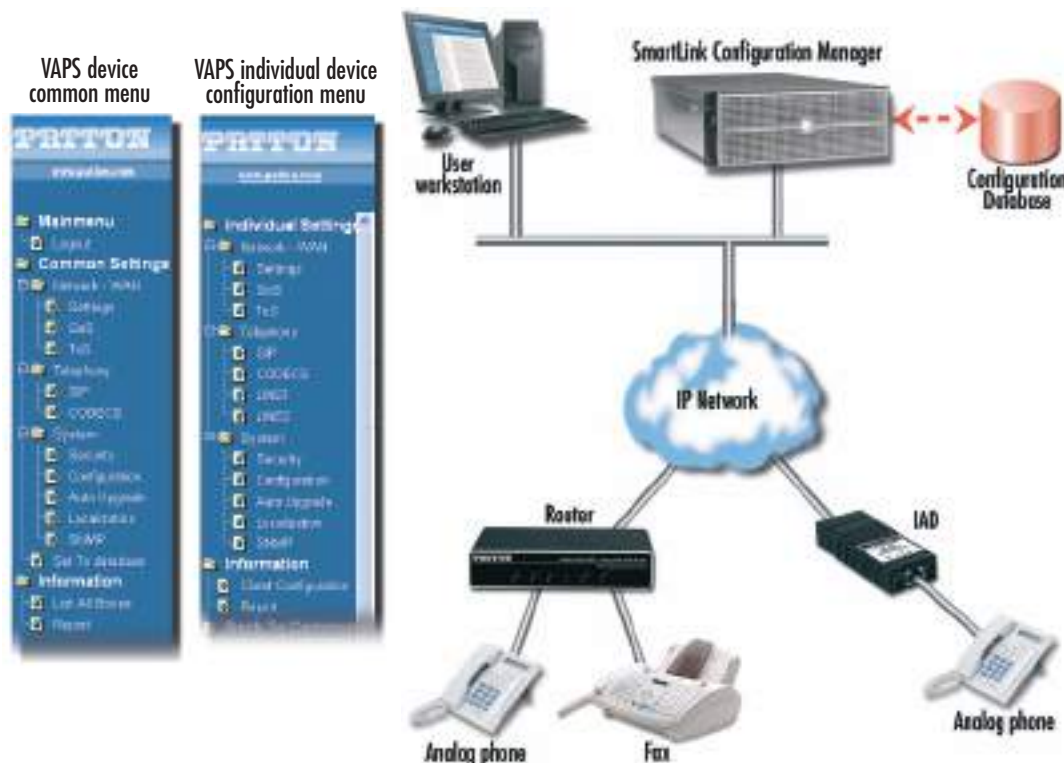

- Manages SmartLink and SmartNode configurations with a common look-and-feel interface.
- Provides a mechanism through either push or pull to automatically update a single device, groups of devices or to make a change across the entire installed base of end user devices.
- Implements VAPS application access security with logging of configuration and access related activities to a syslog.
- Allows application of a group or system wide default configuration to a device or group of devices
- Implements secure transmission of the configuration to and from managed devices.

VAPS system diagram

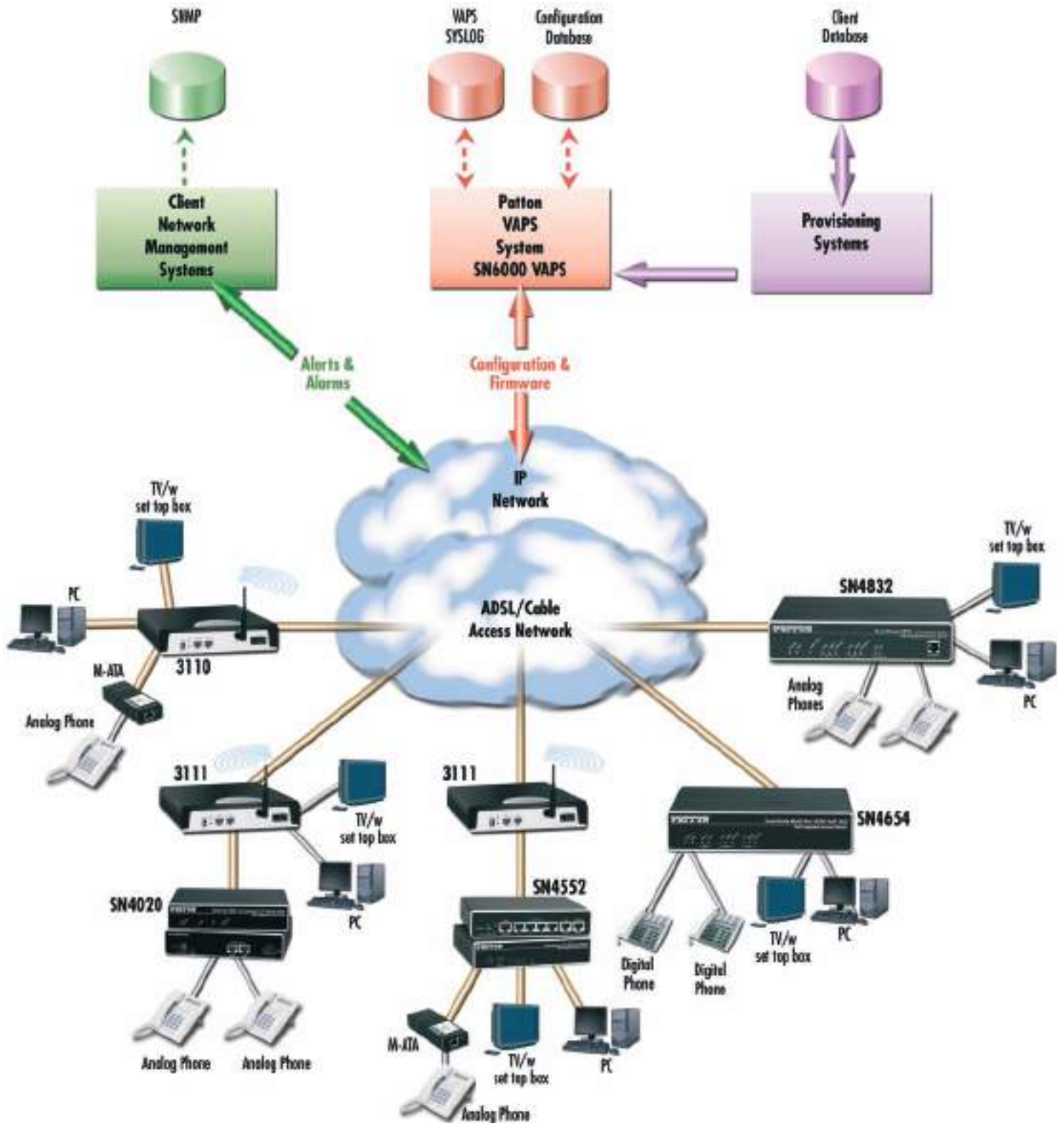

VoIP Bundles

The Patton IP PBX, the SmartNode family of analog and PSTN trunk gateways and VoIP SIP phones are the elements of an enterprise PBX solution that can be purchased as complete turnkey system or as individual elements.

The IP PBX package is designed to serve as a replacement or augmentation to traditional telephony PBX systems while providing access to enhanced telephony features that are only available through VoIP. Single IP PBX systems are targeted for use in the private enterprise networks of up to 150–200 employees. Multiple systems can be implemented in larger organizations to provide seamless calling between systems or sites.

Web based administrative and user interfaces allow for quick and easy adjustment of calling preferences.



EXAMPLE PACKAGE

GS-40-1003 package includes:

Full Function IP PBX for 75 extensions

- Voice Mail
- Auto Attendant
- Voice to email integration
- Hunt Groups

PSTN Gateway

- Up to 24 concurrent PSTN calls
- Analog phone and FAX support

75 VoIP Phones

- 2 line speaker phones
- LCD display
- Local phone book
- Voicemail MWI
- Fax Support

Picking the right PBX package for your office is as easy as 1, 2, 3!

1. Pick your IP PBX		2. Pick your Gateway			3. Pick your Handsets and Complete Package			
Up to # of extensions	Then select your IP-PBX	# of Analog Phones or Faxes	# of PSTN Peak Calls	Then select your Gateway(s)	VoIP Phones	PBX, Gateway and VoIP phone package	Keep your existing Analog phones	PBX, Gateway and Analog phone package
15	SIPxNano-15	≤4	4	SN4528/4JS4JO	(15) SL4050/2	GS-40-1001	SN4912	GS-40-1011
30	SIPxNano-30	≤4	4	SN4528/4JS4JO	(30) SL4050/2	GS-40-1002	SN4932	GS-40-1012
75	SL4250-75	≤4	24	SN2400/1T1 w/(1) 4 FXS	(75) SL4050/2	GS-40-1003	(3) SN4924	GS-40-1013
			30	SN2400/1E1 w/(1) 4 FXS	(75) SL4050/2	GS-40-1004	(3) SN4924	GS-40-1014
125	SL4250-125	8	24	SN2400/1T1 w/(2) 4 FXS	(120) SL4050/2	GS-40-1005	(3) SN4932	GS-40-1015
			30	SN2400/1E1 w/(2) 4 FXS	(125) SL4050/2	GS-40-1006	(3) SN4932	GS-40-1016
250	SL4250-250	8	48	SN2400/2E1 w/(2) 4 FXS	(250) SL4050/2	GS-40-1007	(6) SN4932	GS-40-1017
			60	SN2400/2E1 w/(2) 4 FXS	(250) SL4050/2	GS-40-1008	(6) SN4932	GS-40-1018

Telecommuter/Remote office VoIP equipment selector

You can quickly extend all the capabilities of your office IP-PBX to your tele-workers and remote offices that have a dedicated Internet connection of at least 256 kbps.		+ Local LAN		+ PSTN		
	Number of Phones or Faxes	1	2	1	2	4
	Then Pick →	M-ATA or M-AFA	SL4022	SN4522	SN4522	SN4524

Application diagram



ORDERING INFORMATION

- GS-40-1001SipX: 15 User Package with 4xFXS 4xFXO Gateway; 15x 2-line SIP phones
- GS-40-1011SipX: 15 User Package with 4xFXS 4xFXO Gateway; 12x FXS phone ports
- GS-40-1002SipX: 30 User Package with 4xFXS 4xFXO Gateway; 30x 2-line SIP phones
- GS-40-1012SipX: 30 User Package with 4xFXS 4xFXO Gateway; 32x 2-line SIP phones
- GS-40-1003SL4250: 75 User Package with 1xT1 and 4xFXS Gateway; 75x 2-line SIP phones
- GS-40-1013SL4250: 75 User Package with 1xT1 and 4xFXS Gateway; 72x FXS phone ports
- GS-40-1004SL4250: 75 User Package with 1xE1 and 4xFXS Gateway; 75x 2-line SIP phones
- GS-40-1014SL4250: 75 User Package with 1xE1 and 4xFXS Gateway; 72x FXS phone ports
- GS-40-1005SL4250: 125 User Package with 1xT1 and 8xFXS Gateway; 120x 2-line SIP phones
- GS-40-1015SL4250: 125 User Package with 1xT1 and 8xFXS Gateway; 72x FXS ports
- GS-40-1006SL4250: 125 User Package with 1xE1 and 8xFXS Gateway; 120x 2-line SIP phones
- GS-40-1016SL4250: 125 User Package with 1xE1 and 8xFXS Gateway; 72x FXS ports
- GS-40-1007SL4250: 250 User Package with 1xT1 and 8xFXS Gateway; 250x 2-line SIP phones
- GS-40-1017SL4250: 250 User Package with 1xT1 and 8xFXS Gateway; 144x FXS ports
- GS-40-1008SL4250: 250 User Package with 1xE1 and 8xFXS Gateway; 250x 2-line SIP phones
- GS-40-1018SL4250: 250 User Package with 1xE1 and 8xFXS Gateway; 144x FXS ports

TIME FOR A REALITY CHECK

SmartNode enterprise VoIP telephone and VoIP provider solutions are fully proven, which is why enterprises, carriers, and VoIP providers all over the world choose Patton SmartNode.

And that's why every issue of RealityCheck™ carries success stories of customers using award-winning SmartNode devices in a wide variety of applications. RealityCheck is an invaluable resource and it's **FREE!** So why not subscribe today? Just call +1 301.975.1000 or via the web: www.patton.com/netnews/subscribe/

visit us online
www.patton.com



FAST Delivery From Your AUTHORIZED DISTRIBUTOR!



WAN Routers

Product Line Summary

Product Line	Ethernet Ports	Integrated WAN Interfaces	Model	Description	Pg	
Low-Cost WAN Routers 	1	1 T1/E1	2603	Low-Cost Single Port T1/E1 Access Router	48	
	4	2 T1/E1	2620	Low-Cost Dual-Port T1/E1 Access Router	52	
	1	1 E1	2701/1	Low-Cost Single E1 Access Bridge	62	
	1	1 T1	2720/1	Low-Cost Single T1 Access Bridge	100	
Serial Routers 	Public Access	1	V.35	WAN Router V.35	49	
		1	X.21	WAN Router X.21	49	
		1	V.35	2135	V.35 Micro Bridge	64
		1	X.21	2121	X.21 Micro Bridge	64
		1	V.24 (RS-232)	2124	V.24/RS-232 Micro Bridge	64
Managed VPN Routers 	Private Access	1 or 4-port switch	1 Ethernet	2802/2805	SOHO/Enterprise Secure VPN Router Appliance	46
		2	1 T1/E1	2803	Integrated T1/E1 VPN WAN Access Device	50
		2	V.35	2835	Integrated V.35 VPN WAN Access Device	51
		2	X.21	2821	Integrated X.21 VPN WAN Access Device	51
Edge Routers 	Edge	2 Gigabit Ethernet	2/4 T1/E1 Inverse Multiplexer	2888	T1/E1 Multi-Megabit Edge Router	54
		2 Gigabit Ethernet	2/4 T1/E1	2884	T1/E1 Channelized Gigabit Edge Router	53
		Up to 11	Up to 128 T1/E1 Ports	6400	Modular T1/E1 Edge Router	55

								
Model	2603	2620	2635	2621	2701/1 & 2720/1	2135	2121	2124
Description	Low-Cost Single Port T1/E1 Access Router	Low-Cost T1/E1 Access Router with Drop & Insert	WAN Router V.35	WAN Router X.21	Ethernet-over-T1/E1 WAN Bridge	V.35 Micro Bridge	X.21 Micro Bridge	V.23 (RS-232) Micro Bridge
Form Factor	Desktop				Micro Unit			
Feature Set	Basic Internet Access/Delivery Feature Set				PPP Bridging Feature Set			
Routing & Protocols	RIP V1 and V2, Frame Relay, Inverse ARP, PPP with BCP or IPCP, PPPoE				PPP/BCP			
IP Connectivity Features	NAT/NAPT, DHCP server and relay, DNS relay, SNTP client, PPPoE				-			
QoS	-				-			
VPN/Security	-				-			
Key Features	DoS Detection/Protection. Intrusion detection, blacklisting with automated configurable actions, packet filtering firewall, access list.				-			
	<ul style="list-style-type: none"> Lowest Cost Internet Access Router in the Market Integrated WAN interfaces Full Featured IP Router 				<ul style="list-style-type: none"> Transparent LAN Bridging Standard PPP Bridge Control Protocol Auto Learning and Aging Supports 4096 MAC Address 			

Link-Up for Less

In This Section

Product Highlights

Basic T1/E1 Routers



- Single and dual port T1/E1
- Intrusion Detection and ACL/Filters
- Full Frame Relay & PPP Support
- Advanced IP features include NAT, DHCP, DNS relay

Sync-Serial Routers



- X.21 and V.35 interfaces
- Basic Firewall Functionality
- Advanced IP feature set
- Simple SNMP/HTTP management interface

QoS VPN Routers



- IPSec with DES/3DES/AES
- ACLs and active Packet Filtering
- Active traffic classification, scheduling & prioritization
- Service login feature set (PPPoE/NAT/DHCP)
- T1/E1, Ethernet, and V.35 and X.21 sync-serial interfaces

Edge Routers



- Modular interfaces support from 4 to 208 T1/E1s
- Tunneling protocols supported for port wholesaling
- VPN (PPTP & IPsec) for secure networking

Low-Cost WAN Routers

- Single-Port T1/E1 Access Router • 48
- Dual-Port T1/E1 Access Router • 52
- Single E1 Access Bridge • 62
- Single T1 Access Bridge • 100

Serial Routers

- WAN Router V.35 • 49
- WAN Router X.21 • 49
- V.35 Micro Bridge • 64
- X.21 Micro Bridge • 64
- V.24/RS-232 Micro Bridge • 64

Managed VPN Routers

- SOHO-Secure VPN Router Appliance • 46
- Enterprise-Secure VPN Router Appliance • 46
- Integrated VPN WAN Access Device T1/E1 • 50
- Integrated VPN WAN Access Device V.35 • 51
- Integrated VPN WAN Access Device X.21 • 51

Edge Routers

- Multi-Port T1/E1 Edge Router • 54
- Modular T1/E1 Edge Router • 55

2802/2805	2823	2803	2835	2821	2884	2888	6400
SOHO/Enterprise Secure VPN Ethernet Appliances	Managed DMZ Secure VPN WAN Access Device	Integrated T1/E1 VPN WAN Access Device	Integrated V.35 VPN WAN Access Device	Integrated X.21VPN WAN Access Device	Multi-Port T1/E1 Channelized Gigabit Edge Router	Multi-Port T1/E1 Multi-Megabit Edge Router	Modular T1/E1 Edge Router
Desktop					Desktop & 19" Rack Mount		
Secure, QoS, VPN Feature Set					Edge Router Feature Set		
RIP V1 and V2, Frame Relay, PPP, PPPoE					RIP V1 & V2, OSPFv2 & v3, RIPng, PPP with BCP & IPCP, Multi-Link PPP		
NAT/NAPT, DHCP server and client, PPPoE, VLAN .p/Q					NAT/NAPT, VLAN .p/Q, Tunneling/port wholesaling with L2TP; IP filtering; MAC filtering		
ToS and DiffServ labeling: Active QoS with traffic scheduling and classification. Weighted fair queuing and shaping of traffic classes with configurable burst tolerance; DownStreamQoS™ with dynamic restriction of inbound TCP traffic; IKE; IPsec encryption of voice (VoVPN)					ToS and DiffServ labeling: Active QoS with traffic scheduling and classification. Hierarchical queuing and shaping of traffic classes with configurable burst tolerance; Random Early Discard (RED) for uplink ports. Eight priority queues dedicated for the classification of VLAN traffic.		
DoS Detection/Protection. Intrusion detection, packet filtering firewall, Static Firewall ACLs, IPsec with DES/3DES/AES including Internet Key Exchange (IKE), VPN-Passthrough for PPTP/GRE, PPTP VPN.					Packet filtering firewall, PPTP VPN, L2TP, VLAN, IPsec VPN		
<ul style="list-style-type: none"> • IPSec VPN Tunneling • DES/3DES/AES Encryption 		<ul style="list-style-type: none"> • Firewall and Intrusion Detection • Built-In Router 			<ul style="list-style-type: none"> • OSPF and Other Advanced Routing Features • nxE1 and STM-1 Connectivity • Voice, Video, and Data Quality QoS with Hierarchical Levels of Prioritization 		

WAN Routers

Solutions Center Product Guide

Pg	Model	Product	Application	Solution
48	2603	T1/E1 WAN Access Router	Low-Cost Network Access	Inexpensive T1/E1 Internet access with basic routing support.
49 51	2621/2635 2821/2835	Serial Access Routers	Legacy Network Integration	Convert serial interfaces to Ethernet. Add VPN security to serial interfaces.
52	2620	Dual Port T1/E1 Drop & Insert Router	Integrated TDM and IP Data	Simultaneous delivery of digital voice over fractional T1/E1 and IP data with IP terminated on Ethernet port and voice switched to second T1/E1 port.
46	2802/2805	Managed Ethernet VPN Routers	Secure Triple-Play Router	Manage encrypted voice, video and data flows over IP to create secure building ingress points.
50	2803	Managed T1/E1 VPN Routers	Secure Managed Service	Service provider based Internet Access and IPsec VPN service overlay for remote branch connectivity.
50	2800	Managed VPN Routers and Inverse Multiplexers	Multimedia IP Demarc	Use existing broadband and T1/E1 Internet access networks to create secure private networks with firewalls using strong VPN encryption.
53	2884	Channelized Gigabit Router	Remote Site Monitoring	Create a service handoff point with advanced per flow QoS, support for per flow strong encryption of voice, video and data, and advanced service delivery such as IP Centrex and IP multicast video.
54	2888	Multi-Megabit Inverse Mux	Remote Traffic Backhaul	

Low Cost Network Access

T1/E1 Router

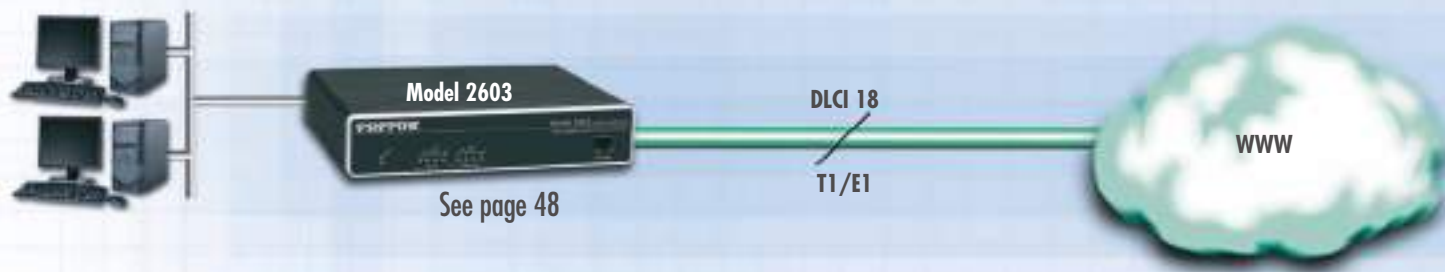

The Model 2603 T1/E1 Router provides basic IP access across T1/E1 lines.

This is our lowest cost T1/E1 router providing basic "Ethernet to T1/E1 converter" functionality. So if you need a low cost WAN router for basic internet access, or IP monitoring of a remote site, this series of products are right for you.

Link-Up for Less

Legacy Network Integration

Serial (V.35/X.21) to Ethernet Conversion



See page 49

- Extend life of serial routers
- Update the functionality of serial network equipment
- Connect to serial NTUs

The Model 2621/2635 WAN Router provides basic IP access across any TDM WAN network by providing standard X.21 and V.35 WAN interfaces

These units are low cost WAN routers which provide "Ethernet to X.21 or V.35 converter" functionality. If you need to add a second Ethernet port to an existing modular router or provide IP access for existing leased-line based networks, the 2621 and 2635 are right for you.

Integrated TDM & IP Data

T1/E1 Drop & Insert

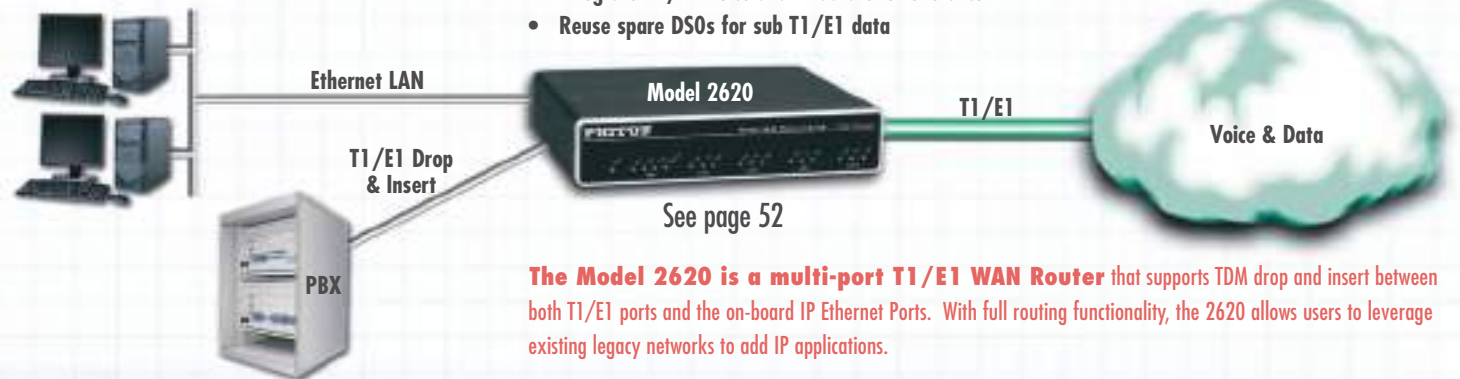

See page 52

- Integrate T1/E1 voice and IP data over one circuit
- Reuse spare DSOs for sub T1/E1 data

The Model 2620 is a multi-port T1/E1 WAN Router that supports TDM drop and insert between both T1/E1 ports and the on-board IP Ethernet Ports. With full routing functionality, the 2620 allows users to leverage existing legacy networks to add IP applications.

If you have an existing leased line or a TDM network carrying legacy TDM data and you want to add some IP connectivity between locations, the Model 2620 is right for you.

Secure Managed Service

Internet Access with Enterprise VPN Service Overlay

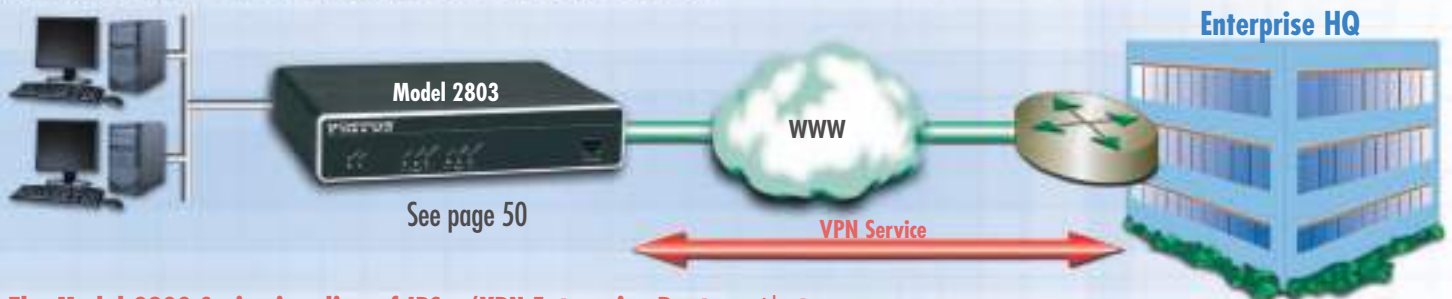

See page 50

The Model 2800 Series is a line of IPSec/VPN Enterprise Routers with strong encryption and a variety of integrated WAN interface options.

If you are a Carrier or Service Provider delivering a managed IP VPN service across WAN circuits, the 2803 series is right for you. Boasting QoS, IPSec/VPN Tunneling as well as DES/3DES and AES encryption, plus Firewall and IKE security, the 2800 series is ideal for your banking, government, and other security-minded customers.

WAN Routers

Solutions Center Product Guide

Remote Traffic Backhaul

TDM Inverse Mux

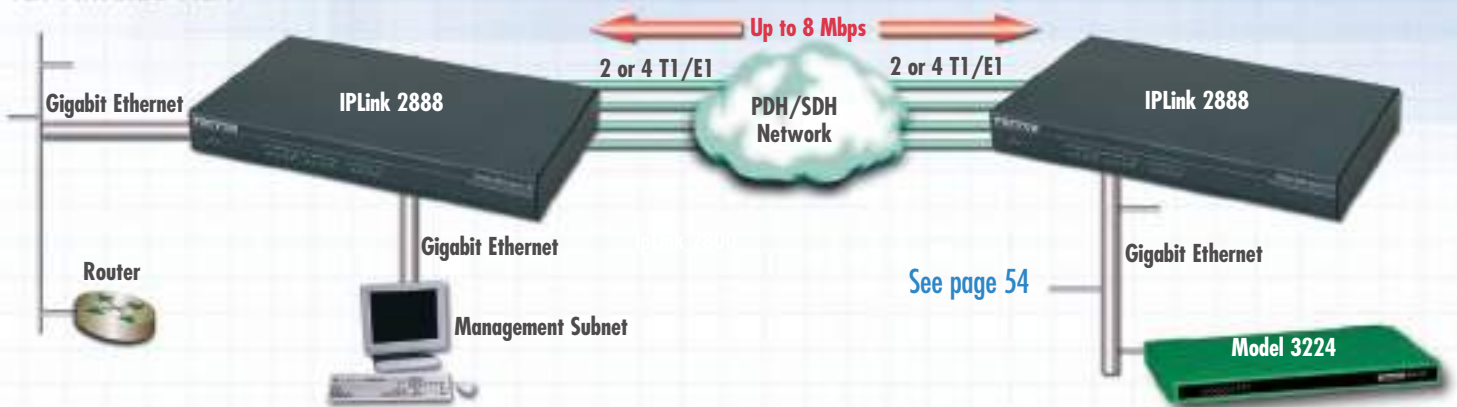

The Model 2888 provides point-to-point high-bandwidth Ethernet/IP connectivity over TDM-based T1/E1 circuits.

If you need to increase raw bandwidth between two locations, the Model 2888 is right for you. An ideal solution for IPDSLAM traffic backhaul, the 2888 uses ML PPP to aggregate up to 4 T1/E1 TDM ports and provide perfect complement to any MxU DSLAM installation.

Remote Site Monitoring

Channelized T1/E1 router

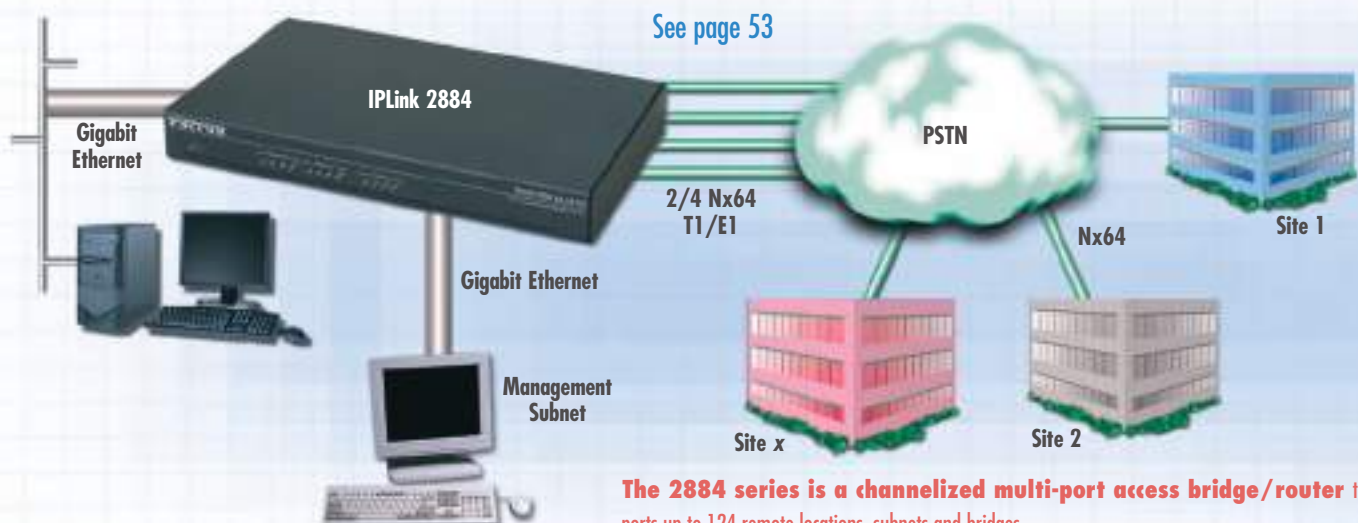

The 2884 series is a channelized multi-port access bridge/router that supports up to 124 remote locations, subnets and bridges.

If you have multiple remote locations to manage, the 2884 provides an ideal companion to any out-of-band network management solution. Equipped with VLAN and RIP support, the 2884 is adept at providing the connectivity required to manage and monitor remote locations.

Link-Up for Less

Secure Triple-Play Router

Secure Voice, Video, & Data



- Firewall with ACLs
- Encrypted voice & data for data integrity
- SNTP time stamping of logged events
- IP multicast/IGMP for redundant video capture

See pages 50

The 2800 series is a line of Routers supporting a full suite of Bandwidth Management and QoS features required for integrated Voice/Data and Video applications

If you are integrating and aggregating voice, data, and video over IP links, the 2800 series is right for you. Supporting IP multi-cast IGMP video streams as well as encrypted voice, data and video, the 2800 series is ideal for creating an integrated security network.



Multimedia IP Demarc

Manage, Monitor, and Manipulate IP Service Flows

- IP service delivery point
- Per flow SLAs/QoS
- Per flow encrypted strong VPN
- Per flow marking/tagging
- Back-to-back user agent with QoS equipment



See pages 50

Internet Access



Video Conference



IP PBX (NanoServ)



The 2800 series is a line of IP Demarc Routers

If you are a Carrier using the new IP access network as your "last mile access" to customers and you need a service level demarcation point to terminate your services, the 2800 series is right for you. By establishing differential Quality of Service metrics for voice, data and video services the 2800 series allows the Carrier to manage and control IP

service flows across IP networks to the customer premise. With the ability to encrypt and decrypt as well as perform tagging and prioritization of any IP flow (voice/data/video) and provide management data, the 2800 series is an ideal IP Demarc for Next Generation Carriers and Service Providers

Ethernet Managed VPN WAN Router

IPLink™ 2802 & 2805

IPLink Managed VPN Routers promote business/dual use of broadband access networks by applying VPN encryption AND QoS/CoS traffic management to traffic flows.



The IPLink Managed VPN Routers are a family of next generation appliances that address both the security and the traffic prioritization needs of enterprises. VPN routers enable the secure communication of remote offices, home offices, and mobile users across insecure IP networks such as the Internet. IPLink VPN Routers take it one step further and integrate quality of service (QoS) to optimize business traffic flows, allowing dual use (business and leisure) of broadband connections without impacting the quality of business communications.

IPLink VPN Routers implement a comprehensive security environment. It all starts with IPSec. By supporting ESP as well as AH, IPLink VPN Routers provide data integrity, authentication, anti-replay and data confidentiality to any

traffic flow. DES, 3DES, and AES provide standard encryption up to 256 bits. Firewall capabilities of the IPLink VPN Routers include Access Control Lists (ACLs), IP address and port filtering, and protection against Denial of Service (DoS) attacks. Likewise, PPPoE protocols include support for PAP and CHAP authentication.

QoS features include ToS/DiffServ marking and the configuration of eight service class tags per IEEE 802.1p/Q. With traffic scheduling and shaping, create dedicated bandwidth guarantees, configurable burst tolerance, and policing to include excess traffic discard. IP fragmentation is configurable to help minimize jitter in traffic flows.

Advanced IP features include RIPv1 & RIPv2 routing and static route configuration. Static and dynamic NAT, NAPT, DNS resolver and relay, dynamic DNS, and DHCP server further add to the capabilities of the IPLink VPN Router. All IPLink VPN routers can be managed via a web browser (HTTP), command line interface (Telnet), or an SNMP management platform.

FEATURES & BENEFITS

- ✓ VPN Tunnels—Standard IPSec with AH and ESP ensures maximum protection when traversing unsecured networks.
- ✓ Strong Encryption—DES, 3DES, and AES offer standards based encryption algorithms from 56 to 256 bits.
- ✓ QoS/CoS Profiles—Configurable burst tolerance, bandwidth guarantees plus reduce per flow traffic jitter as required by the application.
- ✓ Configurable Security Profiles—Built-in IP address and IP port filtering, ACLs and DoS attack detection creates a comprehensive security environment.
- ✓ Enhanced IP Services—DNS resolver and relay, NAT/NAPT, dynamic DNS, and DHCP server, eases integration.
- ✓ 10/100 Ethernet—Dual 10/100 Ethernet and 5 port Ethernet switch.
- ✓ SNMP/HTTP Management—Easily manage the IPLink VPN Routers via a simple web browser interface.

ORDERING INFORMATION

2802/EUI: VPN Router; 2 Ethernet ports; external UI power supply

2805/EUI: VPN Router; 5 Ethernet ports; external UI power supply

Typical application

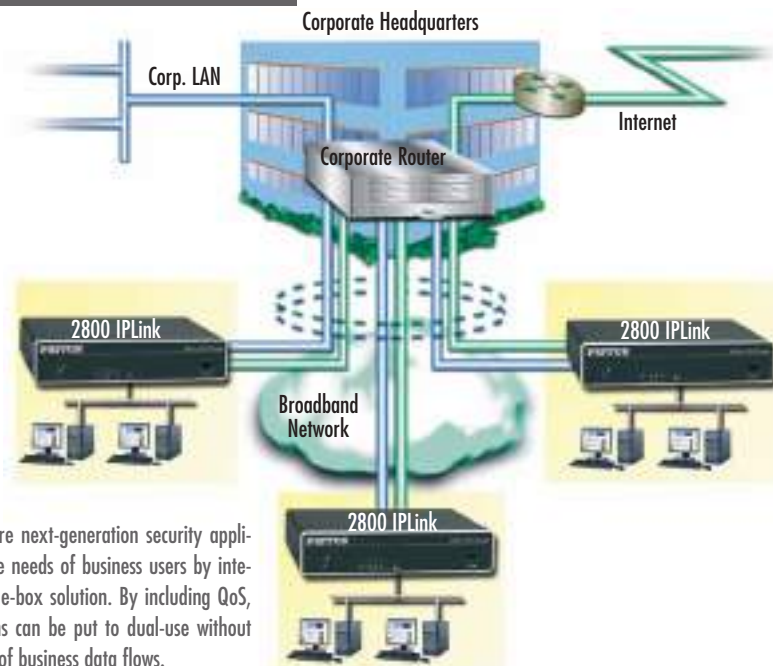

IPLink VPN Routers are next-generation security appliances that address the needs of business users by integrating QoS into a one-box solution. By including QoS, broadband connections can be put to dual-use without impacting the quality of business data flows.

SPECIFICATIONS

WAN Ethernet port:

2802 & 2805—10/100Base-T (RJ-45 connector); auto-negotiating; half/full duplex operation with automatic MDI/MDI-X

LAN Ethernet Ports:

2802—10/100Base-T (RJ-45 connector); auto-negotiating; half or full duplex operation with automatic MDI/MDI-X

2805—4 port 10/100Base-T switch (RJ-45 connector); auto-negotiating; half/full duplex operation with automatic MDI/MDI-X

Management: CLI via Telnet; TFTP for software upgrade and configuration upload; SNMPv1; HTTP/web browser

Protocols: IP (RFC 741), TCP (RFC 793), UDP (RFC 768), ICMP & ICMP Redirect (RFC 792), ARP (RFC 826), IP Router with RIPv1 (RFC 1058), RIPv2 (RFC 2453), programmable static routes, Integrated DHCP Server (RFC 2131), DNS Relay (RFC 1631), IEEE 802.1p VLAN Tagging, NAT/NAPT (RFC 1631/2381), IGMPv2

Security: IPSec including AH and ESP, DES, 3DES, and AES encryption. Access Control Lists (ACLs). IP port and address filtering both by source and destination. DoS Detection. Password protected system management with a username/password for console and virtual terminal, IKE

Power Supplies: External universal 90–260 VAC input or 48 VDC input. (Optional internal universal 90–260 VAC input.)

Compliance: CE Mark; Safety: UL60950-1, CSA 22.2 6095001, IEC/EN60950-1. Universal AC units are US NRTL Listed; EMC Emissions: FCC Part 15 Class A; EN55022 Class A; EMC Immunity: EN55024

Environment: Temp.: 0–40°C (32–104°F); Humidity: 5–80% non-condensing

Dimensions: 7.3W x 1.6H x 6.1D in. (18.5H x 4.1W x 15.5D cm)

Weight: 30.5 oz./500g (models with internal power); 24.4 oz./400g (models with external power; no power supply)

DMZ Secure Router

IPLink™ 2823 Managed VPN Routers

Patton DMZ Secure Routers streamline DMZ implementation and secure-firewall configurations for enterprise networks without sacrificing QoS for critical business traffic.



IPLink Managed VPN Routers are a family of next generation appliances that address both the security and the traffic prioritization needs of enterprises. The Model 2823 Secure DMZ Router with integrated QoS makes it easy for enterprises to isolate their web servers in a secure demilitarized zone (DMZ). The three-port router physically provides and logically separates connections to a private LAN and a DMZ network, while still allowing secure business-class Internet access with traffic-shaping services.

As with all IPLink VPN Routers, the Secure DMZ Router implements a comprehensive security environment. It all starts with IPsec. By supporting ESP as well as AH, IPLink VPN Routers provide data integrity, authentication, anti-replay and

data confidentiality to any traffic flow. DES, 3DES, and AES provide standard encryption up to 256 bits. Firewall capabilities of the IPLink VPN Routers include Access Control Lists (ACLs), IP address and port filtering, and protection against Denial of Service (DoS) attacks. Likewise, PPPoE protocols include support for PAP and CHAP authentication.

QoS features include ToS/DiffServ marking and the configuration of eight service class tags per IEEE 802.1p/Q. With traffic scheduling and shaping, create dedicated bandwidth guarantees, configurable burst tolerance, and policing to include excess traffic discard. IP fragmentation is configurable to help minimize jitter in traffic flows.

Advanced IP features include RIPv1 & RIPv2 routing and static route configuration. Static and dynamic NAT, NATP, DNS resolver and relay, dynamic DNS, and DHCP server further add to the capabilities of the IPLink VPN Router. All IPLink VPN routers can be managed via a web browser (HTTP), command line interface (Telnet), or an SNMP management platform.

FEATURES & BENEFITS

- ✓ Triple-Port Power DMZ—Use to configure the 3rd 10/100 Ethernet port as a physical and logical DMZ to keep traffic off the local network.
- ✓ VPN Tunnels—Standard IPsec with AH and ESP ensures maximum protection when traversing unsecured networks.
- ✓ Strong Encryption—DES, 3DES, and AES offer standards based encryption algorithms from 56 to 256 bits.
- ✓ QoS/CoS Profiles—Configurable burst tolerance, bandwidth guarantees plus reduce per flow traffic jitter as required by the application.
- ✓ Configurable Security Profiles—Built-in IP address and IP port filtering, ACLs and DoS attack detection creates a comprehensive security environment.
- ✓ Enhanced IP Services—DNS resolver and relay, NAT/NAPT, dynamic DNS, and DHCP server, eases integration.
- ✓ SNMP/HTTP Management—Easily manage the IPLink VPN Routers via a simple web browser interface.

ORDERING INFORMATION

- 2823/UI: Secure DMZ Router; external UI power supply
- 2823/48: Secure DMZ Router; 48-VDC power supply

SPECIFICATIONS

WAN Ethernet port: 10/100Base-T (RJ-45 connector); auto-negotiating; half/full duplex operation with automatic MDI/MDI-X
LAN Ethernet Ports: One 10/100BaseT port (RJ-45 connector); auto-negotiating; half or full duplex operation with automatic MDI/MDI-X plus One 10BaseT (RJ-45 connector); half or full duplex with automatic MDI/MDI-X
Management: CLI via Telnet; TFTP for software upgrade and configuration upload; SNMPv1; HTTP/web browser
Protocols: IP (RFC 741), TCP (RFC 793), UDP (RFC 768), ICMP & ICMP Redirect (RFC 792), ARP (RFC 826), IP Router with RIPv1 (RFC 1058), RIPv2 (RFC 2453), programmable static routes. Integrated DHCP Server (RFC 2131), DNS Relay (RFC 1631), IEEE 802.1p VLAN Tagging, NAT/NAPT (RFC 1631/2391)
Security: IPsec including AH and ESP. DES, 3DES, and AES encryption. Access Control Lists (ACLs). IP port and address filtering both by source and destination. DoS Detection. Password protected sys-

tem management with a username/password for console and virtual terminal.
Power Supplies: External universal 90–260 VAC input or 48 VDC input. (Optional Internal universal 90–260 VAC input.)
Compliance: CE Mark; Safety: UL60950-1, CSA 22.2 6095001, IEC/EN60950-1. Universal AC units are US NRTL Listed; EMC Emissions: FCC Part 15 Class A; EN55022 Class A; EMC Immunity: EN55024
Environment: Temp.: 0–40°C (32–104°F); Humidity: 5–80% non-condensing
Dimensions: 7.3W x 1.6H x 6.1D in. (18.5H x 4.1W x 15.5D cm)
Weight: 30.5 oz./500g (models with internal power); 24.4 oz./400g (models with external power; no power supply)

Typical application

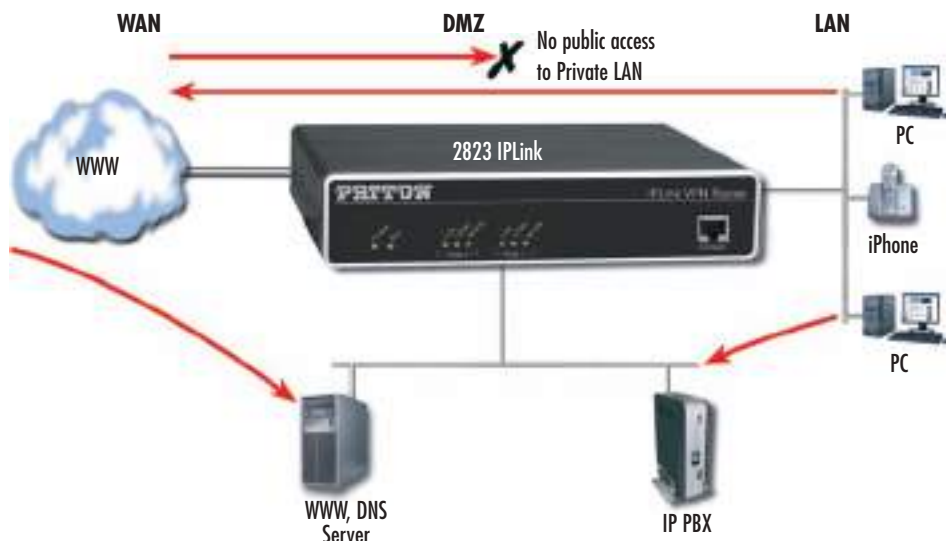

visit us online
www.patton.com

FAST Delivery From Your AUTHORIZED DISTRIBUTOR!



Low-cost T1/E1 WAN Access Router

IPLink™ 2603

This WAN Gateway Router is a complete all-in-one network access device which easily connects your IP/LAN to any T1/E1 network interface with routed or bridged connections



The Models 2603 Gateway Router is the ideal solution for connecting any small to medium-sized enterprise or remote office to an IP/Internet network using standard telco and WAN interfaces.

Combining ease-of-use with a full suite of LAN/WAN routing features, the IPLink routers provide selectable bridging or routing functionality along with advanced IP features such as NAT/NAPT, Firewall, and DHCP. A complete set of configurable FR/PPP/IP WAN protocols allow a wide range of choices when connecting branches via common WAN services. The IPLink Routers boast easy installation offering Console/VT-100, Telnet, and HTTP/SNMP management options.

The IPLink 2603 come with an auto-sensing full-duplex 10/100Base-T Ethernet port, cross-over switch, and internal

power supply. The Model 2603 is equipped with an integrated T1/E1 CSU/DSU for connection to full and fractional T1/E1 services.

Patton's new series of high-speed routers offer the versatility and reliability demanded for business-class applications at the most affordable price.

Why use our IPLink Router?

Patton's IPLink 2603 Gateway router delivers all the advanced features for secure, reliable, and high speed Internet data connections. It combines ease-of-use with powerful data routing to make shared Internet connectivity simple and easy.

With NAT support, the IPLink router offers convenient and economical operation by using a single IP address while the integrated DHCP server automates IP address assignment for connected LAN computers. Security is standard with built-in firewall and violation alerting features that protect the network from would-be intruders.

Patton stands behind our products—we are the only company in the industry offering free configuration support, free technical services, and a minimum one-year warranty on all our products.

FEATURES & BENEFITS

- ✓ T1/E1 WAN interface in industry-standard connectors
- ✓ PPP and Frame Relay — Versatile WAN options enable deployment into any network. Use routed IP or bridged Ethernet for transparent networking. Bridge passes VLAN tagged frames (no VLAN tagging within the 2603)
- ✓ NAT/NAPT, Firewall, DHCP — Powerful routing features make shared Internet connectivity simple and secure.
- ✓ 10/100 Ethernet with MDI-X — Easily connect to any computer or LAN — the built-in communication crossover switch eliminates messy configuration cables.
- ✓ WWW/SNMP Manageable — Built-in VT-100 console port makes setup a *snap*, and you can use the embedded HTTP/SNMP agent to manage an IPLink router from anywhere in the world.

SPECIFICATIONS

WAN Interface: T1/E1 (RJ-48C)

Ethernet Connection: Single-port 10/100Base-T switch, auto-sensing, full/half-duplex operation, built-in MDI-X

Management: EIA-561 RJ-45 RS-232, VT-100 CLI, TELNET, Embedded WEB/HTTP, SNMP, Logging events: POST, POST errors, line/DSL, PPP/DHCP.

Protocol: IP (RFC 741), TCP (RFC 793), UDP (RFC 768), ICMP (RFC 950), ARP (RFC 826), BCP (RFC 1638) • IP Router with RIP (RFC 1058), RIPv2 (RFC 2453), Integrated DHCP Server (RFC 2131) • Selectable IP leases and MAC/IP pairings • DHCP relay agent (RFC 2132/RFC 1542) with 8 address pools. DNS Relay, IGMP v1 and v2 • Ethernet Bridging • NAT/NAPT with integrated application support. MultiNat with 1:1 mapping, Many:1, Many:Many mapping, NAT Port/IP redirection and mapping

Security: DoS Detection/protection. Intrusion detection, Logging of session, blocking and intrusion events and Real-

Time alerts, Password protected system management with a username/password for console and virtual terminal, Packet filtering firewall for controlled access to and from LAN/WAN • Support for 255 rules in 32 filter sets • 16 individual connection profiles • Access list determining up to 5 hosts/networks which are allowed to access management system SNMP/HTTP/TELNET

Indicators: 12 LEDs: Power, Link, Loss, Loop, Back-Up WAN signals; Link, TX, RX LAN signals

Power Supply: Internal universal 90-260 VAC input or 48 VDC input.

Compliance: FCC Part 15A, CE Mark, EMC Directive 89/336/EEC, Low-Voltage Directive 73/23/EEC, EN60950, EN55022 (CISPR 22) • FCC part 68.

Environment: Temp.: 32–122°F (0–50°C) • Humidity: 5–90%, non-condensing

Dimensions: 7.3 x 6.6 x 1.62 inch (185 x 168 x 41 mm)

ORDERING INFORMATION

2603/K/EU1: E1 (RJ-45/BNC) Router with external UI power supply

2603/K/48: T1/E1 (RJ-45/BNC) Router with 48-VDC power supply

2603/T/EU1: T1 (RJ-45) Router with external UI power supply

2603/T/48: T1/E1 (RJ-45) Router with 48-VDC power supply

Application diagram

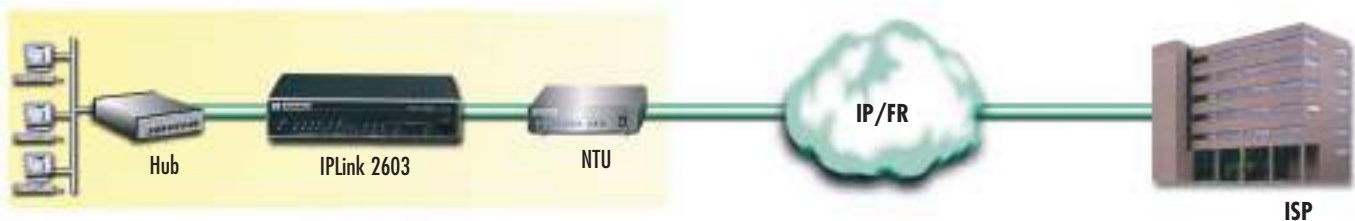

Sync. Serial WAN Routers

IPLink™ 2621 & 2635

These WAN Gateway Routers are complete all-in-one network access devices that easily connect your IP/LAN to any X.21 or V.35 network interface with routed or bridged connections



The Models 2621 and 2635 Gateway Routers are the ideal solution for connecting any small to medium-sized enterprise or remote office to an IP/Internet network using standard telco and WAN interfaces.

Combining ease-of-use with a full suite of LAN/WAN routing features, the IPLink routers provide selectable bridging or routing functionality along with advanced IP features such as NAT/NAPT, Firewall, and DHCP. A complete set of configurable FR/PPP/IP WAN protocols allow a wide range of choices when connecting branches via common WAN services. The IPLink Routers boast easy installation offering Console/VT-100, Telnet, and HTTP/SNMP management options.

All IPLink routers come with an auto-sensing full-duplex 10/100Base-T Ethernet port, cross-over switch, and internal power supply. The Model 2621 has an X.21 interface, and the Model 2635 comes with a V.35 interface.

ORDERING INFORMATION

2621/EU: X.21 Router; external UI power supply

2621/48: X.21 Router; external 48-VDC power supply

Patton's new series of high-speed routers offer the versatility and reliability demanded for business-class applications at the most affordable price.

Why use our IPLink Routers?

IPLink Gateway routers deliver all the advanced features for secure, reliable, and high speed Internet data connections. They combine ease-of-use with powerful data routing to make shared Internet connectivity simple and easy.

With NAT support, the IPLink routers offer convenient and economical operation by using a single IP address while the integrated DHCP server automates IP address assignment for connected LAN computers. Security is standard with built-in firewall and violation alerting features that protect the network from would-be intruders.

Available with such standard WAN sync-serial interfaces as V.35 and X.21, the IPLink series gives you the right interface needed for your WAN service.

Patton stands behind our products—we are the only company in the industry offering free configuration support, free technical services, and a minimum one-year warranty on all our products.

FEATURES & BENEFITS

- ✓ V.35 or X.21 WAN interfaces—Get the WAN interface you need in industry-standard connectors
- ✓ PPP and Frame Relay—Versatile WAN options enable deployment into any network. Use routed IP or Bridged Ethernet for transparent networking. Bridge passes VLAN tagged frames (no VLAN tagging within the 2635/2621)
- ✓ NAT/NAPT, Firewall, DHCP—Powerful routing features make shared Internet connectivity simple and secure.
- ✓ 10/100 Ethernet with MDI-X—Easily connect to any computer or LAN—the built-in communication crossover switch eliminates messy configuration cables.
- ✓ WWW/SNMP Manageable—Built-in VT-100 console port makes setup a snap, and you can use the embedded HTTP/SNMP agent to manage the IPLink routers from anywhere in the world.

SPECIFICATIONS

WAN Interface: 2635: V.35 (M/34F) • 2621: X.21 (DB-15F)

Ethernet Connection: Single-port 10/100Base-T switch • auto-sensing • full/half-duplex operation • built-in MDI-X

Management: EIA-561 RJ-45 RS-232, VT-100 CLI, TELNET, Embedded WEB/HTTP, SNMP, Logging events: POST, POST errors, line/DSL, PPP/DHCP.

Protocol: IP (RFC 741), TCP (RFC 793), UDP (RFC 768), ICMP (RFC 950), ARP (RFC 826), BCP (RFC 1638) • IP Router with RIP (RFC 1058), RIPv2 (RFC 2453), Integrated DHCP Server (RFC 2131) • Selectable IP leases and MAC/IP pairings • DHCP relay agent (RFC 2132/RFC 1542) with 8 address pools • DNS Relay • IGMP v1 and v2 • Ethernet Bridging • NAT/NAPT with integrated application support, MultiNat with 1:1 mapping, Many:1, Many:Many mapping, NAT Port/IP redirection and mapping

Security: DoS Detection/protection • Intrusion detection, Logging of session, blocking and intrusion events and Real-Time alerts, Password protected system

management with a username/password for console and virtual terminal, Packet filtering firewall for controlled access to and from LAN/WAN • Support for 255 rules in 32 filter sets • 16 individual connection profiles • Access list determining up to 5 hosts/networks which are allowed to access management system SNMP/HTTP/TELNET

Indicators: 12 LEDs: Power, Link, Loss, Loop, Back-Up WAN signals; Link, TX, RX LAN signals

Power: Internal universal 90–260 VAC input or 48 VDC input.

Compliance: FCC Part 15A, CE Mark, EMC Directive 89/336/EEC, Low-Voltage Directive 73/23/EEC, EN60950, EN55022 (CISPR 22) • FCC part 68.

Environment: Temp.: 32–122°F (0–50°C) • Humidity: 5–90%, non-condensing

Dimensions: 7.3 x 6.6 x 1.62 inch (185 x 168 x 41 mm)

Application diagram

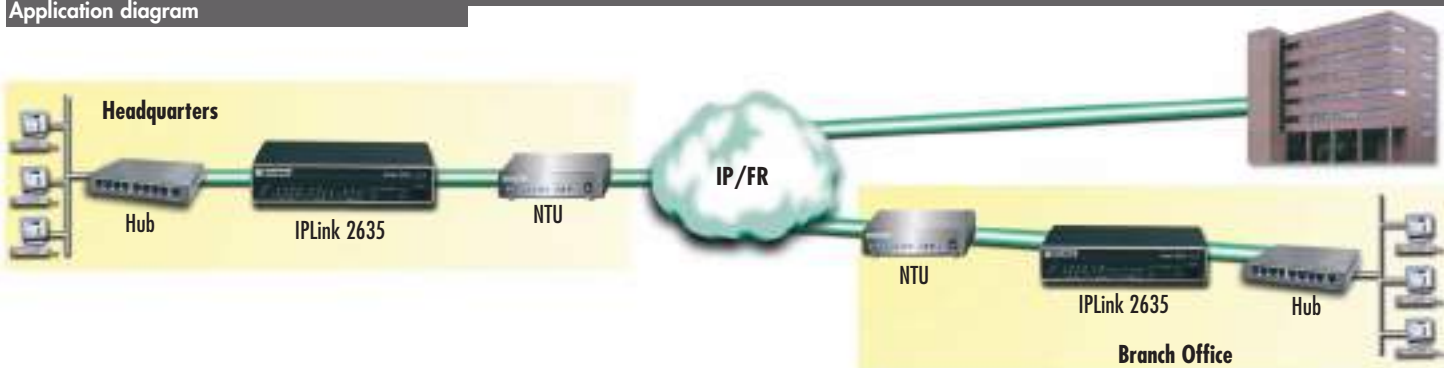

visit us online
www.patton.com

FAST Delivery From Your AUTHORIZED DISTRIBUTOR!



T1/E1 Managed VPN WAN Router

IPLink™ 2803

Multimedia-enable any Access TDM network.



The IPLink Managed T1/E1 VPN Router with integrated WAN port is a multimedia router with built-in NTU that manages, monitors and manipulates IP traffic flows to create a service quality control point for IP traffic going over TDM networks. The Model 2803 addresses both the security and the traffic prioritization needs of enterprises and service providers alike through its support for strong encryption of all traffic flows as well as key multimedia features such as prioritization of voice, video and data traffic, IP multicast and IGMP, and embedded VoIP gateway.

VPN routers enable the secure communication of remote offices, home offices, and mobile users across insecure IP networks such as the Internet. IPLink VPN Routers take it one step further and integrate quality of service (QoS) to optimize business traffic flows plus include an NTU to eliminate the need for external converters. IPLink VPN Routers imple-

ment a comprehensive security environment and encrypt all flows including VoIP and video flows.

It all starts with IPsec. By supporting ESP as well as AH, IPLink VPN Routers provide data integrity, authentication, anti-replay and data confidentiality to any traffic flow. DES, 3DES, and AES provide standard encryption up to 256 bits. Firewall capabilities of the IPLink VPN Routers include Access Control Lists (ACLs), IP address and port filtering, and protection against Denial of Service (DoS) attacks. Likewise, PPP/PPPoE protocols include support for PAP and CHAP authentication.

QoS features include ToS/DiffServ marking and the configuration of eight service class tags per IEEE 802.1p/Q. With traffic scheduling and shaping, create dedicated bandwidth guarantees, configurable burst tolerance, and policing to include excess traffic discard. IP, PPP, and Frame Relay fragmentation is configurable to help minimize jitter in traffic flows.

Advanced IP features include IGMP and IP multicast support as well as RIPv1 & RIPv2 routing and static route configuration. Static and dynamic NAT, NAPT, DNS resolver and relay, dynamic DNS, and DHCP server further add to the capabilities of the IPLink VPN Router. Frame Relay support is included standard. All IPLink VPN routers can be managed via a web browser (HTTP), command line interface (Telnet or Console), or an SNMP management platform. IKE is included for ease of key management.

FEATURES & BENEFITS

- ✓ Strong encryption of traffic including VoIP & video flows
- ✓ IP multicast and IGMP support
- ✓ True multimedia QoS with traffic class prioritization
- ✓ VoIP SIP proxy with built-in NAT, DHCP relay and DynDNS
- ✓ Embedded T1/E1 NTU with loopback and alarms
- ✓ VLAN per IEEE 802.1Q including priority queuing

ORDERING INFORMATION

2803/K/EUI: VPN Router, 2 Ethernet ports, 1 T1/E1 part with RJ & BNC, external UI power supply

2803/K/48: VPN Router, 2 Ethernet ports, 1 T1/E1 part with RJ & BNC, 48-VDC power supply

2803/T/EUI: VPN Router, 2 Ethernet ports, 1 T1/E1 port RJ only, external UI power supply

2803/T/48: VPN Router, 2 Ethernet ports, 1 T1/E1 port RJ only, 48-VDC power supply



I'm Joe, one of Patton's Senior Product Managers. If you have any questions about products or applications using WAN Routers, please call me at +1 301.975.1000, x137, or via e-mail at joe@patton.com.

SPECIFICATIONS

WAN ports: 2803: One T1/E1. (E1—G.703/G.704 with HDB3 and AMI encoding. T1—ANSI T1.403 & AT&T TR54016 with AMI coding/D4 framing or 8B2S coding/ESF framing. RJ-48C connector and/or dual BNC available. 2835: V.35 DTE on DB-25F Connector 2821: X.21 DTE or DCE on DB-15F Connector

Ethernet ports: Two 10/100Base-T ports (RJ-45 connector); auto-negotiating; half or full duplex operation with built-in MDI-X

Management: CLI via Telnet Ethernet or RS-232 Console Port (EIA-564); TFTP for Software upgrade and configuration upload; SNMPv1; HTTP/web browser

Protocols: IP (RFC 741), TCP (RFC 793), UDP (RFC 768), ICMP & ICMP Redirect (RFC 792), ARP (RFC 826). IP Router with RIPv1 (RFC 1058), RIPv2 (RFC 2453), programmable static routes. Integrated DHCP Server (RFC 2131), DNS Relay (RFC 1631), IEEE 802.1p VLAN Tagging, NAT/NAPT (RFC 1631/2391); IGMPv2

Security: IPsec including AH and ESP. DES, 3DES, and AES encryption. Access Control Lists (ACLs). IP port and address filtering both by source and destination. DoS Detection. Password protected system management with a username/password for console and virtual terminal; IKE

Power: External universal 90–260 VAC input or 48 VDC input. (Optional Internal universal 90–260 VAC input.)
Compliance: CE Mark; Safety: UL60950-1, CSA 22.2 6095001, IEC/EN60950-1. Universal AC units are US NRTL Listed; EMC Emissions: FCC Part 15 Class A; EN55022 Class A; EMC Immunity: EN55024

Environment: Temp.: 0–40°C (32–104°F) • Humidity: 5–80% non-condensing

Dimensions: 7.3W x 1.6H x 6.1D in. (18.5H x 4.1W x 15.5D cm)

Weight: 30.5 oz./500g (models with internal power); 24.4 oz./400g (models with external power; no power supply)

Application diagram

IPLink VPN Routers are next generation security appliances that address the needs of business users by integrating QoS and WAN interfaces into a one-box solution. Service Providers

can take advantage of the built-in QoS to provide both VPN services as well as managed bandwidth services using IPLink VPN Routers.

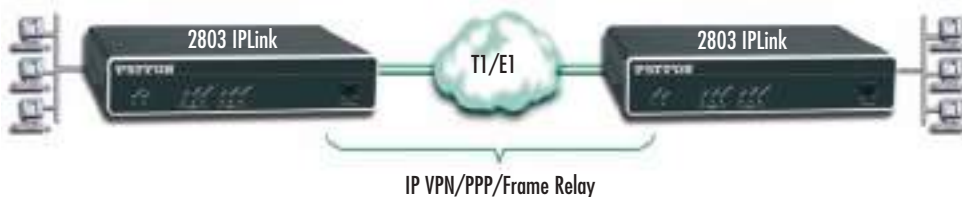

Sync. Serial Managed VPN WAN Router

IPLink™ 2821 & 2835

IPLink Managed VPN Routers with integrated WAN ports optimize and secure information flows applying VPN encryption and QoS/CoS traffic management.



The IPLink Managed VPN Routers with integrated serial ports are a family of next generation appliances that address both the security and the traffic prioritization needs of enterprises. VPN routers enable the secure communication of remote offices, home offices, and mobile users across insecure IP networks such as the Internet. IPLink VPN Routers take it one step further and integrate quality of service (QoS) to optimize business traffic flows plus include a serial port to eliminate the need for external converters.

IPLink™ VPN Routers implement a comprehensive security environment. It all starts with IPSec. By supporting ESP as well as AH, IPLink VPN Routers provide data integrity, authentication, anti-replay and data confidentiality to any

traffic flow. DES, 3DES, and AES provide standard encryption up to 256 bits. Firewall capabilities of the IPLink VPN Routers include Access Control Lists (ACLs), IP address and port filtering, and protection against Denial of Service (DoS) attacks. Likewise, PPP/PPPoE protocols include support for PAP and CHAP authentication.

QoS features include ToS/DiffServ marking and the configuration of eight service class tags per IEEE 802.1p/Q. With traffic scheduling and shaping, create dedicated bandwidth guarantees, configurable burst tolerance, and policing to include excess traffic discard. IP, PPP, and Frame Relay fragmentation is configurable to help minimize jitter in traffic flows.

Advanced IP features include RIPv1 & RIPv2 routing and static route configuration. Static and dynamic NAT, NAPT, DNS resolver and relay, dynamic DNS, and DHCP server further add to the capabilities of the IPLink VPN Router. Frame Relay support is included standard. All IPLink VPN routers can be managed via a web browser (HTTP), command line interface (Telnet or Console), or an SNMP management platform.

FEATURES & BENEFITS

- ✓ V.35 and X.21 — Get the integrated serial port you need.
- ✓ VPN Tunnels — Standard IPSec with AH and ESP ensures maximum protection when traversing unsecured networks.
- ✓ Strong Encryption — DES, 3DES, and AES offer standards based encryption algorithms from 56 to 256 bits.
- ✓ QoS/CoS Profiles — Configurable burst tolerance, bandwidth guarantees plus reduce per flow traffic jitter as required by the application.
- ✓ Configurable Security Profiles — Built-in IP address and IP port filtering, ACLs and DoS attack detection creates a comprehensive security environment.
- ✓ Enhanced IP Services — DNS resolver and relay, NAT/NAPT, dynamic DNS, and DHCP server, eases integration.
- ✓ SNMP/HTTP Management — Easily manage the IPLink VPN Routers via a simple web browser interface.

ORDERING INFORMATION

2821/EUI: VPN Router, 2 Ethernet ports, 1 X.21 port with DB15 connector, external UI power supply

2821/K/48: VPN Router, 2 Ethernet ports, 1 X.21 port with DB15 connector, 48-VDC power supply

2835/EUI: VPN Router, 2 Ethernet ports, 1 V.35 port with M34 connector, external UI power supply

2835/48: VPN Router, 2 Ethernet ports, 1 V.35 port with M34 connector, 48-VDC UI power supply

SPECIFICATIONS

WAN ports: 2835—V.35 DTE on DB-25F connector • 2821—X.21 DTE or DCE on DB-15F connector

Ethernet ports: Two 10/100Base-T ports (RJ-45 connector); auto-negotiating; half or full duplex operation with built-in MDI-X

Management: CLI via Telnet Ethernet or RS-232 Console Port (EIA-564); TFTP for Software upgrade and configuration upload; SNMPv1; HTTP/web browser

Protocols: IP (RFC 741), TCP (RFC 793), UDP (RFC 768), ICMP & ICMP Redirect (RFC 792), ARP (RFC 826), IP

Router with RIPv1 (RFC 1058), RIPv2 (RFC 2453), programmable static routes. Integrated DHCP Server (RFC 2131), DNS Relay (RFC 1631), IEEE 802.1p VLAN Tagging, NAT/NAPT (RFC 1631/2391); IGMPv2

Security: IPSec including AH and ESP, DES, 3DES, and AES encryption. Access Control Lists (ACLs). IP port and address filtering both by source and destination. DoS Detection. Password protected system management with a username/password for console and virtual terminal; IKE

Power supplies: External universal 90–260 VAC input or 48 VDC input. (Optional internal universal 90–260 VAC input.)

Compliance: CE Mark; Safety: UL60950-1, CSA 22.2 6095001, IEC/EN60950-1. Universal AC units are US NRTL Listed; EMC Emissions: FCC Part 15 Class A; EN55022 Class A; EMC Immunity: EN55024

Environment: Temp.: 0–40°C (32–104°F); Humidity: 5–80% non-condensing

Dimensions:

7.3W x 1.6H x 6.1D in. (18.5H x 4.1W x 15.5D cm)

Weight: 30.5 oz./500g (models with internal power); 24.4 oz./400g (models with external power; no power supply)



I'm Nathan, Patton's NMS Product Line Manager. If you do not find the solutions you need at www.patton.com or in this catalog, please call me at +1 301.975.1000, x129. You can also send e-mail to nathan@patton.com.



Application diagram

IPLink VPN Routers are next generation security appliances that address the needs of business users by integrating QoS and WAN interfaces into a one-box solution. Service Providers can take advantage of the built-in QoS to provide both VPN services as well as managed bandwidth services using IPLink VPN Routers.

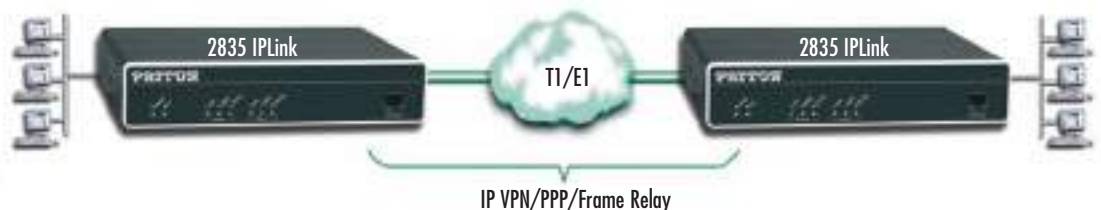

visit us online
www.patton.com

FAST Delivery From Your AUTHORIZED DISTRIBUTOR!



Integrated TDM & IP Routers

IPLink™ 2620

Link up effortlessly with the Patton Model 2620 Dual-Port T1/E1 IPLink Router combines two T1/E1 and four 10/100 Ethernet ports to deliver drop and insert and WAN bandwidth to the most demanding access applications.



This dual-port T1/E1 router is a versatile access router supporting drop and insert T1/E1 applications as well as high-speed WAN IP network access.

Combining ease-of-use with a full suite of LAN/WAN routing features, the Model 2620 provides selectable bridging or routing functionality along with advanced IP features such as NAT/NAPT, DNS relay, and DHCP server and relay. Numerous firewall features, including the ability to filter by IP address and by IP port, support for Intrusion Detection (IDS), and the capability of “blacklisting” offending traffic flows, likewise come standard with the unit.

ORDERING INFORMATION

2620/KK/EU1: E1 Router, D&I port, Quad 10/100 Ethernet, 90–260 VAC PS

2620/TT/EU1: T1 Router, D&I with Quad 10/100 Ethernet, 90–260 VAC PS

A complete set of configurable FR/PPP/IP WAN protocols allow a wide range of choices when connecting equipment via common WAN services. By supporting the latest version of PPP/BCP, the IPLink transparently negotiates the passing of VLAN traffic. Deployments can also take advantage of the Model 2620's full implementation of Frame Relay to support Frame Relay VPN deployments over switched carrier networks.

The Model 2620 boasts easy installation offering Console/VT-100, Telnet, and HTTP/SNMP management options. All IPLink Routers come with a four port auto-sensing full-duplex 10/100Base-T Ethernet switch, the choice of internal or external power supply and two T1/E1 WAN ports with built-in CSU/DSU.

Patton's series of high-speed access routers offer the versatility and reliability demanded for business-class applications at the most affordable price.

2620/KK/48: E1 Router, D&I port, Quad 10/100 Ethernet, internal 36–72 VDC PS

2620/TT/48: T1 Router, D&I with Quad 10/100 Ethernet, internal 36–72 VDC PS

FEATURES & BENEFITS

- ✓ Dual T1/E1 with Drop & Insert— Easily take any DSO from one T1/E1 port and switch it to the other.
- ✓ Four 10/100 Ethernet— Easily bridge the gap between the LAN and WAN.
- ✓ Terminate nx64 data, Frame Relay, or PPP encapsulated IP traffic on channelized interfaces.
- ✓ Enhanced IP Services— DNS relay, NAT/NAPT, DHCP server and relay, make it easy to offer any service.
- ✓ Firewall with Standard DoS & Filtering— Built-in IP address and IP port filtering, intrusion detection and blacklisting capabilities make firewall services a snap.

SPECIFICATIONS

WAN ports: Two software configurable ports. E1—G.703/G.704 with HDB3 and AMI encoding support. T1—ANSI T1.403 & AT&T TR54016 with AMI coding/D4 framing or B8ZS coding/ESF framing

Ethernet Ports: Four port 10/100Base-T (RJ-45 connector) • auto-negotiating • half or full duplex operation with built-in MDI-X

Management: HTTP/SNMP, Telnet, Ethernet, RS-232 Console Port, SYSLOG Client, Software upgrade via TFTP, SNTF

Protocols: IP (RFC 741), TCP (RFC 793), UDP (RFC 768), ICMP (RFC 950), ARP (RFC 826) • IP Router with RIP (RFC 1058) and RIPv2 (RFC 2453), integrated DHCP Server (RFC 2131) with selectable IP leases and MAC/IP pairings • DHCP relay agent (RFC 2132/RFC 1542) with 8 address pools • DNS Relay, IGMP v1 and v2, Ethernet Bridging • NAT/NAPT with integrated application support, MultiNat with 1:1 mapping,

Many:1, Many:Many mapping, NAT Port/IP redirection and mapping

Security: DoS Detection/protection • Intrusion detection, Logging of session, blocking of intrusion events and Real-Time alerts, Password protected system management with a username/password for console and virtual terminal, Packet filtering firewall for controlled access to and from LAN/WAN. Support for 255 rules in 32 filter sets. 16 individual connection

Power: Internal universal 90–260 VAC input or 48 VDC input.

Compliance: FCC Part 15A, CE Mark, EMC Directive 89/336/EEC, Low-Voltage Directive 73/23/EEC, EN60950, EN55022 (CISPR 22) • FCC part 68

Environment: Temp.: 0–50°C (32–122 °F) • Humidity: 5–90% non-condensing

Dimensions: 7.3 x 6.6 x 1.62 in. (185 x 168 x 41 mm)

Typical Internet Application

With Dual T1/E1 ports, the IPLink Model 2620 maximizes the use of the up-link network and minimizes the cost of deploying the service by implementing Drop & Insert of DSO channels between the T1/E1 ports. The remaining bandwidth can then be used to provide other value added IP access services or even LAN extension over any of the four 10/100 Ethernet ports. For bandwidth hungry applications, traffic from both T1/E1 ports can be bonded together using multi-link PPP.

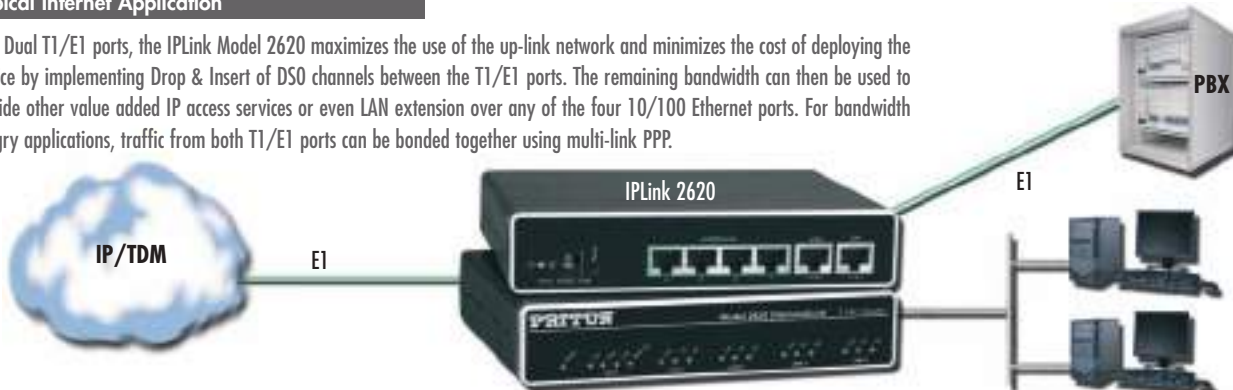

Channelized Gigabit Router

IPLink™ 2884 T1/E1 Router

Patton's IPLink Channelized Gigabit multi-media routers concentrate up to 124 WAN connections or bond up to 4 T1/E1s for an 8 Mbps link to serve high-density and bandwidth hungry applications.



The Model 2884 Series T1/E1 Channelized Gigabit Routers are a family of multi-media routers that terminate up to 124 PPP channels as well as perform Layer 2 bonding of T1/E1 WAN ports with multi-link PPP. Dual Gigabit Ethernet ports ensure connection to any LAN infrastructure.

The IPLink Channelized Gigabit Routers offer pre-set priorities for voice and video traffic on a per port basis up to a user configurable bandwidth. QoS configurations ease the bandwidth management of ports and applications through the creation of QoS classes and profiles. Traffic can be shaped and policed to provide full QoS control over both the egress

and ingress directions. ToS/DiffServ bits can be re-stripped to ensure network-wide QoS enforcement. VLAN priority bits can be used for QoS enforcement.

Stateful Firewall inspection of traffic is accomplished through the creation of Access Control Lists (ACLs) that enable the filtering of traffic based on numerous criteria including source and destination IP address, port and protocol.

Logical and physical ports are selectable for bridging or routing. Advanced IP features such NAT/NAPT and VLANs are likewise configurable on a per port basis. By supporting the latest version of PPP/BCP, the IPLink transparently negotiates the passing of VLAN traffic over PPP based WAN links. Bridged traffic can be tagged and prioritized according to user defined parameters.

The 2884 Model Series boasts easy installation, offering CLI configuration via Console/VT-100 or Telnet/SSH, and HTTP web based management, and SNMP. Patton's series of high-speed access routers offer the versatility and reliability demanded for business-class applications at the most affordable price.

FEATURES & BENEFITS

- ✓ 2/4 port Channelized T1/E1 — Support up to 124 PPP sessions with up to 4 channelized T1/E1 ports.
- ✓ ML PPP Expands Bandwidth — Bind any number of channels or T1/E1 ports to create up to an 8-Mbps WAN link.
- ✓ Dual Gigabit Ethernet Ports — With Dual 10/100/1000, auto-MDI ports easily connect to any LAN infrastructure.
- ✓ Per Flow QoS — Traffic rates are set through ACLs that shape and police VLAN and IP traffic.
- ✓ Stateful Firewall Inspection through ACLs that filter by source and destination IP address, IP port and protocol.
- ✓ VLAN Tagging — VLAN tagging and processing is configurable on any T1/E1 channel or Ethernet port.
- ✓ Easy Management — Easily manage the 2884 router via an HTTP/web interface, a CLI accessible via the VT100 console or through Telnet/SSH, or via SNMP.

SPECIFICATIONS

WAN ports: Two or Four software configurable channelized ports. E1 — G.703/G.704 with HDB3 and AMI encoding support. T1 — ANSI T1.403 & AT&T TR54016 with AMI coding/D4 framing or B8ZS coding/ESF framing.

Ethernet Ports: Two port 10/100/1000BaseT (RJ-45 connector); auto-negotiating; half or full duplex operation with built-in MDI-X

Management: HTTP/SNMP, Telnet/SSH Ethernet, RS-232 Console Port, SYSLOG Client. Software upgrade via TFTP

Protocols: IP (RFC 741), TCP (RFC 793), UDP (RFC 768), ICMP (RFC 950), ARP (RFC 826). IP Router with RIP (RFC 1058) and RIPv2 (RFC 2453), integrated DHCP Server (RFC 2131) with selectable IP leases and MAC/IP pairings; IGMP v1 and v2, Ethernet Bridging, NAT/NAPT with integrated application support, MultiNat with 1:1 mapping, Many:1, Many:Many mapping, NAT Port/IP redi-

rection and mapping; PPP/BCP, PP/PCP; IEEE 802.1p/Q VLAN Tagging and Priority

Security: Logging of session, Password protected system management with a username/password for console and virtual terminal, Packet filtering firewall for controlled access to and from LAN/WAN. ACL rule and profile creation; SSH for secure remote access.

Power Supplies: Internal universal 100–240 VAC input (50/60 Hz). Less 15W power consumption.

Compliance: EMC Compliance: EB55022 and EN55024

Safety Compliance: EN 60950
FCC Part 15A, CE Mark, FCC part 68, CS-03

Environment:
Operating temperature: 32–122 °F (0–50 °C)

Humidity: up to 90% non-condensing

Dimensions:
11 x 1.5 x 7 in. (280 x 39 x 180 mm)

Remote Site Monitoring

The 2884 series is a channelized multi-port access bridge/router that supports up to 124 remote locations, subnets and bridges.

If you have multiple remote locations to manage, the 2884 provides an ideal companion to any out-of-band network management solution. Equipped with VLAN and RIP support, the 2884 is adept at providing the connectivity required to manage and monitor remote locations.

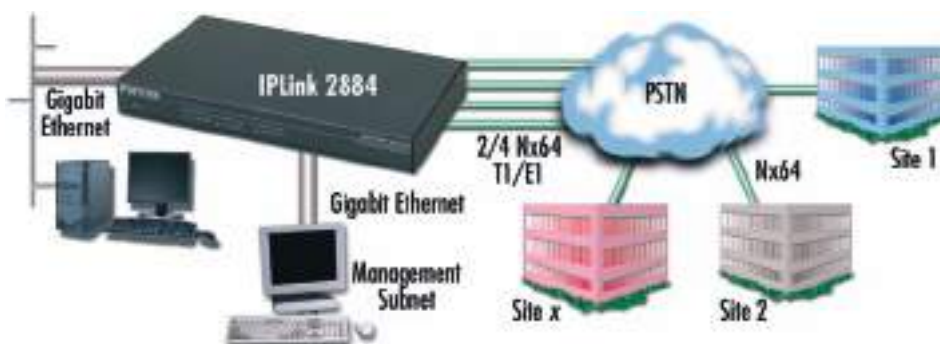

ORDERING INFORMATION

2884/2/UK: Dual-Port, T1/E1 Dual Gigabit-Ethernet Router, internal 100–240 VAC power supply

2884/4/UK: Quad-Port, T1/E1 Dual Gigabit-Ethernet Router, internal 100–240 VAC power supply

Multi-Megabit Inverse Mux

IPLink™ 2888

Patton's IPLink™ Multi-Megabit Inverse Multiplexer facilitates the bonding of up to 4 T1/E1 ports into a high-bandwidth WAN link to feed the most bandwidth hungry applications.



The Model 2888 Four-Port T1/E1 Multi-Megabit Inverse Multiplexer provides point-to-point high-bandwidth Ethernet/IP connectivity over TDM-based T1/E1 circuits. Dual 10/100/1000 Ethernet ports ensure easy connection to any LAN infrastructure.

In order to maximize the bandwidth utilization over the T1/E1 links, the Multi-Megabit Inverse Mux uses Multi-Link PPP to bond the individual circuits into one high bandwidth WAN link. Ethernet/IP traffic is transparently bridged over the link using PPP/BCP which adds minimal encapsulation overhead when compared to ATM.

SPECIFICATIONS

WAN ports: Four software-configurable channelized ports. E1 – G.703/G.704 with HD83 and AMI encoding support. T1 – ANSI T1.403 & AT&T TR54016 with AMI coding/D4 framing or 8B2S coding/ESF framing.

Ethernet Ports: Two-port 10/100/1000Base-T (RJ-45 connector); auto-negotiating; half or full duplex operation with built-in MDI-X
Management: HTTP/SNMP, Telnet/SSH Ethernet, RS-232 Console Port, SYSLOG Client, Software upgrade via TFTP

Protocols: IP (RFC 741), TCP (RFC 793), UDP (RFC 768), ICMP (RFC 950), ARP (RFC 826); IGMP v1 and v2, Ethernet Bridging.; PPP/BCP, IEEE 802.1p/Q VLAN Tagging and Priority
Security: Password protected system management with a username/password

for console and virtual terminal, Packet filtering firewall for controlled management access, ACL rule and profiles; SSH for secure remote access.
Power Supplies: Internal universal 100–240 VAC input (50/60 Hz). Less 15W power consumption.

FEATURES & BENEFITS

- ✓ 4-port T1/E1 Inverse Mux — Using ML PPP bond from 2-4 T1/E1 ports to create a single high-bandwidth WAN link over TDM circuits.
- ✓ Dual Gigabit Ethernet Ports — With Dual 10/100/1000, auto-MDI ports easily connect to any LAN infrastructure.
- ✓ End-to-end QoS — Inspect and preserve VLAN priority as well as ToS/Diffserv bits to maintain end-to-end QoS.
- ✓ VLAN Trunk Extension — Tag untagged traffic, preserve VLAN QoS, or simply transparently forward VLAN traffic.
- ✓ Layer 3 Traffic Filtering — Assign an ACL to the bridge or VLAN connection
- ✓ VLAN Tagging — VLAN tagging and processing is configurable on any T1/E1 channel or Ethernet port.
- ✓ Easy Management — Easily manage the 2888 router via an HTTP/web interface, a CLI accessible via the VT100 console or through Telnet/SSH, or via SNMP.
- ✓ Large MTU size support for frame sizes greater than 9216.

ORDERING INFORMATION

2888/2/UJ: Dual-Port, Dual Gigabit-Ethernet Router, internal 100–240 VAC power supply

2888/4/UJ: Quad-Port, Dual Gigabit-Ethernet Router, internal 100–240 VAC power supply

Compliance: EMC Compliance: EB55022 and EN55024
 Safety Compliance: EN 60950
 FCC Part 15A, CE Mark, FCC part 68, CS-03
Environment: Operating temperature: 32–122°F (0–50°C)

Humidity: up to 90% non-condensing
Dimensions: 11 x 1.5 x 7 in. (280 x 39 x 180 mm)

Remote Traffic Backhaul

The Model 2888 provides point-to-point high-bandwidth Ethernet/IP connectivity over TDM-based T1/E1 circuits.

If you need to increase raw bandwidth between two locations the Model 2888 is right for you. An ideal solution for IPDSLAM traffic backhaul, the 2888 uses ML-PPP to aggregate up to 4 T1/E1 TDM ports and provide perfect complement to any MxU DSLAM installation.

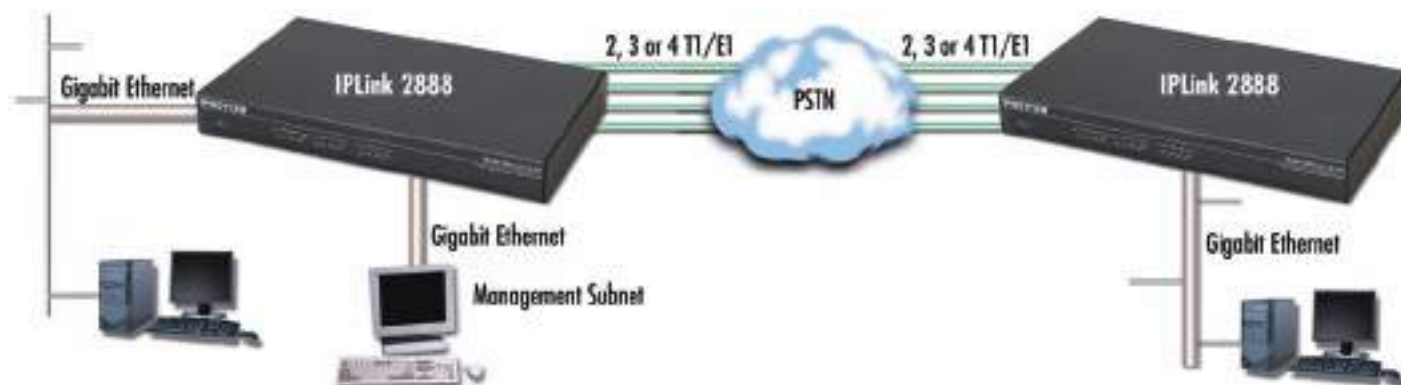

Modular T1/E1 Routers

ForeFront™ 6400 Series Edge/Access Routers

Patton's ForeFront™ Edge/Access TDM Router line delivers carrier grade IP networking and helps service providers integrate TDM based services with core MPLS networks.



The Patton ForeFront™ 6400 Edge/Access Router Series redefines carrier grade networking with the unparalleled redundancy and upgradeability needed to establish service commitments and optimize capital investments. Flexible, rugged and easily upgradeable, it is a platform for current and future networking needs including next-generation narrowband, broadband, and multimedia requirements.

The 6400 Model Series can accept nx64 or full T1/E1 traffic and ease the integration of TDM technologies with modern broadband networks by supporting per subscriber Ethernet VLAN tagging conforming to 802.1p/Q standards. Simple bridging configurations are likewise supported. When used in conjunction with Patton Model 2616RC cards, the solution permits drop & insert of DSO circuits as well as the cross-connecting and multiplexing of TDM (DSO) traffic.

ForeFront Routers are equipped to meet the most demanding needs of organizations. Advanced QoS/CoS mechanisms reliably guarantee bandwidth and set burst tolerances for traffic flows. Access Control Lists (ACL) permit the level of filtering needed to provide service differentiation on a per port basis.

ForeFront Modular Routers offer a robust, reliable solution complete with power distribution, thermal management, and a redundant high-speed backplane.

FEATURES & BENEFITS

- ✓ **Carrier Grade**—Integrated cooling, redundant backplane, hot-swappable components, redundant power.
- ✓ **MPLS Integration via VLAN**—Use VLAN tags to make traffic from TDM circuit transparent to core MPLS networks supporting broadband subscribers.
- ✓ **Drop & Insert**—Take any TDM channel from any port and perform a Drop & Insert to any other port.
- ✓ **Multimedia Ready**—Support for IGMP efficiently handles multicast multimedia applications.
- ✓ **QoS/CoS**—Configure bursts, guarantee bandwidth and reduce per flow traffic jitter.
- ✓ **Management Features**—Configurable alarm reporting with SNMP Traps, HTTP, SNMP, Telnet Ethernet, RS-232 Console Port, SYSLOG Client, Software upgrade via FTP, SSH, NTP, RADIUS Authentication (RFC 2865 & 2868), Accounting (RFC 2866 & 2867).

Application diagram

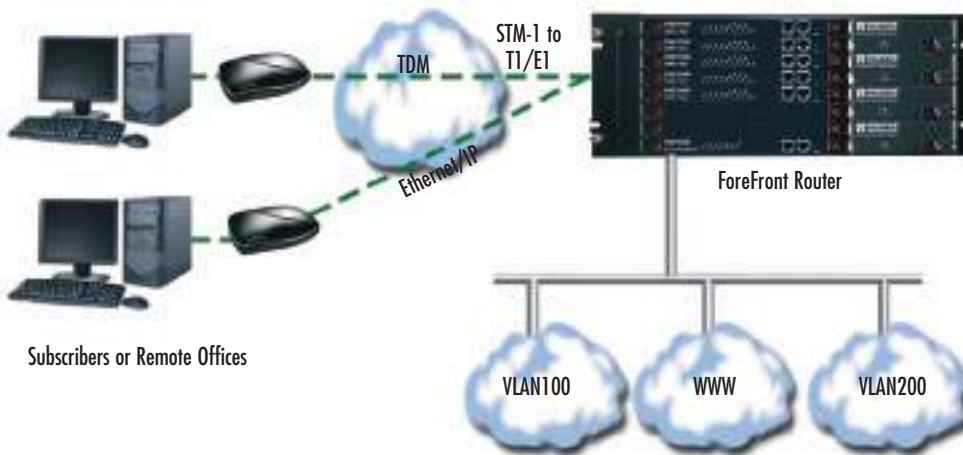

Subscribers or Remote Offices

SPECIFICATIONS

Routing: RIPv1 (RFC 1058), RIPv2 (RFC 2453), OSPFv2 (RFC 2328), VLSM (RFC 1878)

T1/E1 Ports: Software configurable: T1 (AMI/B8ZS line coding) or E1 (HDB3/AMI line coding), G.703, G.704, G.723

IP Services: ARP (RFC0826), Proxy-ARP (RFC1027), ICMP (RFC0950), RFC1256, NTPv3 (RFC1305), IGMP & IGMPv2 (RFC2236), DiffServ (RFC2474),

NAT (RFC 1631/2663/2766/2993), PAP (RFC 1332), CHAP (RFC 1334 & 1994)

Ethernet Ports: One to three 10/100Base-T (RJ-45 connector); auto-negotiating; half or full duplex operation. Optional Dual and Quad Gigabit Ethernet ports are available.

Front Panel Indicators: LEDs for power, CPU, system, Ethernet, External clock, and test mode

Management Service: HTTP, SNMP, Telnet Ethernet, RS-232 Console Port, SYSLOG Client, Software upgrade via FTP, SSH, NTP, RADIUS Authentication (RFC 2865 & 2868), Accounting (RFC 2866 & 2867)

Alarm Reporting: Configurable alarms; Remote SNMP Traps; Front Panel LEDs

Compliance: Safety: UL/CSA per UL1950 (METS) Canadian cMET and CS-03. EMC Directive 89/336/EEC, Low-Voltage Directive 73/23/EEC (EN60950), FCC Part 15, CE Mark, CTR12, CTR13, FCC Part 68

Environment
Operating temperature: 0–40°C (32–104 °F)
Humidity: 5–90% non-condensing



I'm Glen, one of Patton's Product Marketing Managers. If you do not find what you need at www.patton.com or in this catalog, please call me at +1 301.975.1000, x356. You can also send e-mail to gflowers@patton.com.

ORDERING INFORMATION*

6423/16E/R48: One 2U-high 4-slot chassis with DC power, 16 T1/E1 ports, and router card with 3 10/100 Ethernet ports

6423/32E/R48: One 2U-high 4-slot chassis with DC power, 32 T1/E1 ports, and router card with 3 10/100 Ethernet ports

6423/16E/RUI: One 2U-high 4-slot chassis with AC power, 16 T1/E1 ports, and router card with 3 10/100 Ethernet ports

6423/32E/RUI: One 2U-high 4-slot chassis with AC power, 32 T1/E1 ports, and router card with 3 10/100 Ethernet ports

6443/16E/R48: One 4U-high 8-slot chassis with DC power, 16 T1/E1 ports, and router card with 3 10/100 Ethernet ports

6443/32E/R48: One 4U-high 8-slot chassis with DC power, 32 T1/E1 ports, and router card with 3 10/100 Ethernet ports

6443/16E/RUI: One 4U-high 8-slot chassis with AC power, 32 T1/E1 ports, and router card with 3 10/100 Ethernet ports

6443/32E/RUI: One 4U-high 8-slot chassis with AC power, 32 T1/E1 ports, and router card with 3 10/100 Ethernet ports

6423/1S/R48: One 4U-high 8-slot chassis with DC power, 32 T1/E1 ports, and router card with 3 10/100 Ethernet ports

*Call for additional model numbers.

visit us online
www.patton.com

FAST Delivery From Your AUTHORIZED DISTRIBUTOR!



Wide Area Ethernet

Copper Ethernet Extension

In This Section









Copper Ethernet Extenders 57

50 Mbps Multi-Rate Ethernet Extender	57
16.67 Mbps Multi-Rate Ethernet Extender	58
12.5 Mbps CopperLink™ Ethernet Extender	59
2.3 & 4.6 Mbps Ethernet Extenders with Auto-Rate Adaptation	60
144 kbps LAN Extender	61
IP Network Camera Extender	62
CopperLink™-T Extender	63

Bridges 64

Compact Ethernet-over-E1 WAN Bridge	64
Ethernet MicroBridges (X.21, RS-232, RS-530, & V.35)	65

CopperLink™...Going the Distance!

Model	Max. Distance	Max. Speed	Distance at Max. Speed	Rack Card	Photo	Pg
2172	1 mile (1.6 km)	50 Mbps	800 feet (244 m)	No		57
2168	1.1 miles (1.8 km)	16.6 Mbps	3,125 feet (953 m)			58
2158	0.75 miles (1.2 km)	12 Mbps	4,000 feet (1,219 m)			59
2157	5.7 miles (9.1 km)	4.6 Mbps	2 miles (3.2 km)	No		60
2156	5.7 miles (9.1 km)	2.3 Mbps	3.1 miles (5 km)	No		61
2155	5 miles (8.0 km)	144 kbps	5 miles (8 km)	No		62

Other Ethernet Extension Applications

- ✓ Campus LAN Connectivity
- ✓ Secure IP Networks (Dark Fiber)
- ✓ Metropolitan IP Networks
- ✓ Mission-Critical IP Links
- ✓ City LANs
- ✓ Multi-Dwelling, Multi-Tenant IP Services

Our Full Range of CopperLink Ethernet Extenders

Extend your Ethernet connectivity over existing copper infrastructures with Patton's CopperLink Ethernet Extenders. Whether your requirement is sending Ethernet data over long distances or at high speeds, there is a Patton CopperLink Ethernet Extender for you. Use the table above to select the best model for you.

Revitalize your copper today!

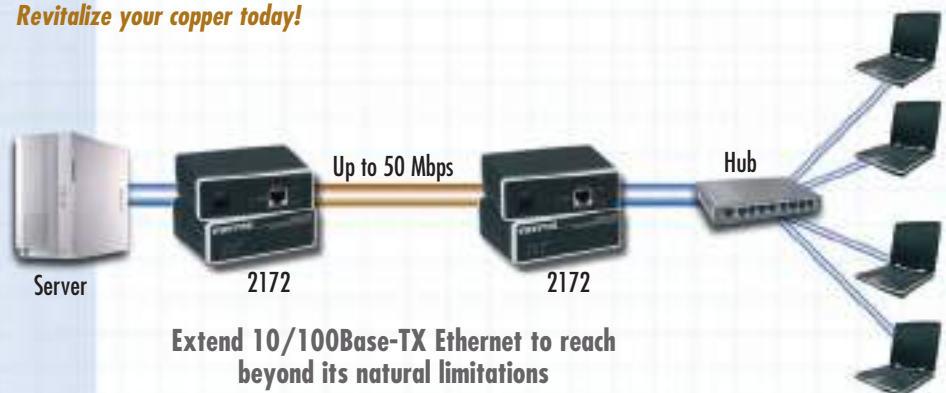



See Pg 134



See Pg 144

50 Mbps Multi-Rate CopperLink™ Ethernet Extender Model 2172

The CopperLink 2172 breaks both distance and speed barriers with up to 50-Mbps full-duplex and distances of up to 5,500 feet (1,700 meters). Now a single twisted-pair can go the distance without sacrificing speed or cost.



The CopperLink™ Model 2172 Ultra-High-Speed Ethernet Extender leverages existing copper infrastructure to deliver high-speed Ethernet extension. Providing data rates up to 50 Mbps in each direction for an aggregated full-duplex speed of 100 Mbps, the Model 2172 is the perfect solution for delivering triple-play communications services and other bandwidth-intensive applications. CopperLink™ Ethernet Extenders easily inter-connect remote devices or remote networks to a central LAN for such applications as medical imaging, video-conferencing, Ethernet bridging, Triple Play, and VoIP.

Six user-selectable settings for symmetrical and asymmetrical rates provide the flexibility required to achieve the optimal speed-distance combination for each and every connection. Multi-rate symmetrical line rates allow each connection to be tuned for the length and gauge of the copper wire, in order to achieve the maximum possible data rate for the environment. Multi-rate asymmetrical line rates make the Model 2172 the ideal solution for service providers who want to differentiate their services or extend the reach of their customer base.

Get near-fiber performance without the expense with Patton's Ultra High-Speed CopperLink™ Ethernet Extender!

SPECIFICATIONS

CopperLink line interface: RJ-45 (pin 4 = ring; pin 5 = tip)
Ethernet interface: 8-position shielded RJ-45. Auto-sensing 10/100Base-T with half or full-duplex operation. DIP switch capable of disabling 100-Mbps full-duplex for equipment that does not support 802.3X (Pause Packets)
Protocol: Transparent to high layer protocol. Supports 802.1Q VLAN tagging
Modulation: Quadrature Amplitude Modulation (QAM) 4-band
Duplexing Method: FDD (Frequency Division Duplexing)
Frequency Range: CopperLink: 0–12 MHz
Transmission: CopperLink line rate: Up to 50 Mbps

Surge suppression: CopperLink line maximum current surge: 20kA (8/20µs) gas tube
Front Panel Indicators: Power, Link, Ethernet
Power Supply: External AC and DC options: 120VAC, and universal input (UI)—100–240 VAC, or optional -48 VDC, -24 VDC, or -12 VDC
Compliance: FCC Part 15A, CE Mark, EMC Directive 89/336/EEC, Low-Voltage Directive 73/23/EEC
Environment: Temp.: 32–122°F (0–50°C)
Humidity: Up to 90% non-condensing
Dimensions: 1.5H x 4.13W x 3.75D in. (3.81H x 10.5W x 9.53D cm)
Weight: 0.4 lbs (0.18 kg) without power supply

FEATURES & BENEFITS

- ✓ Operates Over Twisted Pair—Reduces the cost and hassles of new installations. Utilizes installed voice-grade twisted pairs to eliminate the expense of fiber or Cat5e cabling.
- ✓ Full-duplex data-line rate of 100 Mbps—Provides near fiber performance for bandwidth intensive applications such as Triple Play services.
- ✓ Plug and Play—No configuration or cable hassles during installation with auto-sensing 10/100, full or half duplex, and auto MDI-X.
- ✓ Multiple Line Rates Supported—Switch-selectable line rates ensure the best possible line rate for each application

ORDERING INFORMATION

- 2172/EUI: 50-Mbps Ethernet Extender, 100–240 VAC*
- 2172/EUI-2PK**: 50-Mbps Ethernet Extender K, 100–240 VAC*

Environmentally Hardened 50 Mbps CopperLink Ethernet Extender; 100–240 VAC

- ET2172/UI: Extended Temp -40 to 85°C Remote Extender
- EC2172/UI: Environmentally Controlled 0 to 85°C Remote Extender
- EHA2172/UI: Environmentally Hardened 0 to 50°C Remote Extender
- EHA2172/UI: Environmentally Hardened (external connector), 0 to 50°C Remote Extender

* -12, -24, and -48 VDC power options available.
 **You must specify a country specific power cord

Model 2172 Extension Distances

DS/US* Line Settings	Throughput	26 AWG (0.4 mm)	24 AWG (0.5 mm)	22 AWG (0.6 mm)	19 AWG (0.9 mm)
50/50 Mbps	48 Mbps	600 feet (184 m)	800 (243 m)	1,000 (306 m)	1,500 (460 m)
25/25 Mbps	24.5 Mbps	1,500 feet (458 m)	2,000 (610 m)	2,500 (763 m)	2,750 (1,144 m)
10/10 Mbps	10 Mbps	3,000 feet (900 m)	4,000 (1,200 m)	5,000 (1,500 m)	7,500 (2,250 m)
4/1 Mbps	3.75/1 Mbps	4,500 feet (1,373 m)	6,000 (1,830 m)	7,500 (2,288 m)	11,250 (3,430 m)
16/2 Mbps	15/2 Mbps	3,000 feet (900 m)	4,000 (1,200 m)	5,000 (1,500 m)	7,500 (2,350 m)
50/2 Mbps	48/2 Mbps	1,500 feet (458 m)	2,000 (610 m)	2,500 (763 m)	3,750 (1,144 m)

Workgroup Ethernet extension application

Model 2172 Extenders provide Ethernet to remote buildings beyond the 328-foot (100-meter) distance limit of Ethernet. 100 Mbps throughput eliminates bandwidth concerns experienced

with other copper wired transmission technologies. By using existing voice grade copper pairs the expense and hassle of installing low capacitance or fiber cable is no longer required.



Extend 10/100Base-TX Ethernet to reach beyond its natural limitations

Up to 800 feet (243 meters) at 50 Mbps over voice-grade twisted-pair

16.67 Mbps Multi-Rate CopperLink™ Ethernet Extender

Model 2168

Multi-rate high speed Ethernet extension over voice-grade wire.



The Patton Model 2168 Multi-Rate CopperLink Ethernet Extender enables the utilization of existing copper infrastructure for high speed Ethernet extensions at data rates up to 16.67 Mbps. The Model 2168 Ethernet Extender includes seven asymmetrical and symmetrical settings which provide the flexibility to increase the distance or speed of the Ethernet connections.

CopperLink applications include Ethernet extension, medical imaging, video-conferencing, Ethernet Bridging, and inter-con-

necting remote devices or remote networks to a central LAN. The multi-rate symmetrical line rates ensure the highest possible data rate is achieved over various lengths and types of copper wire and environments. Multi-rate asymmetrical line rates make the Model 2168 the ideal solution for service providers who want to differentiate their services or extend the reach of their customer base. The Model 2168 allows service providers to offer unparalleled performance for such applications as always on Internet access, real time bi-directional video streaming, and various multimedia applications.

If you want to take your network and voice connections farther and faster over existing copper and eliminate the expense of fiber, Patton's CopperLink Ethernet Extenders are the products for you!

Just plug it in, power it on, and play!



Workgroup Ethernet extension application



Ethernet Extender allows copper instead of fiber for vertical Ethernet spans!

These multi-rate Ethernet Extenders are ideal for bridging Ethernet spans inside buildings that are beyond the 328-foot (100-meter) distance limit of Ethernet.

For example, connecting workgroups located on different floors in a building no longer requires expensive switches or the installation of low capacitance cable.

SPECIFICATIONS

Line Interface: RJ-45 or terminal block

Ethernet Interface: Shielded RJ-45

POTS-ISDN Interface: RJ-45 (pin 4=ring, pin5=tip)

Transmission: Switch selectable async. and sync. line rates up to 16.67 Mbps

Surge suppression: CopperLink 20kA (8/20_{μs}) gas tube

Power Supply: External AC: UI (100–240); DC: -48, -24, and -12; DC power supplies are optional

Dimensions: 1.5H x 4.13W x 3.75D in.

3.81H x 10.5W x 9.53D cm
Weight: 0.4 lbs (0.18 kg) without power supply

FEATURES & BENEFITS

- ✓ Low cost/plug and play solution for campus wide network extension and delivery of last-mile ISP services over Ethernet
- ✓ Switch selectable asymmetrical or symmetrical line rates up to 16.67 Mbps!
- ✓ Auto-sensing 10Base-T/100Base-TX port
- ✓ Supports full or half-duplex Ethernet
- ✓ Transparent LAN bridging (Passes 802.1Q (VLAN) packets)
- ✓ Automatic learning, aging, & filtering source address table
- ✓ Stand alone and rack mount versions

Symmetric or asymmetric variable-rate VDSL

Line rates can be set on the standalones and rack cards to differentiate services and increase the distance of the individual links.

Asymmetric

Line Rates		Distance
Upstream	Downstream	26 AWG (0.4 mm)
1.56 Mbps	4.17 Mbps	6,000 feet (1,829 m)
1.56 Mbps	9.38 Mbps	5,500 feet (1,676 m)
2.34 Mbps	16.67 Mbps	5,000 feet (1,524 m)

Symmetric

Line Rates		Distance
Upstream	Downstream	26 AWG (0.4 mm)
6.25 Mbps	6.25 Mbps	4,500 feet (1,372 m)
9.38 Mbps	9.38 Mbps	4,150 feet (1,265 m)
12.50 Mbps	12.50 Mbps	4,000 feet (1,220 m)
16.67 Mbps	16.67 Mbps	3,300 feet (1,006 m)

ORDERING INFORMATION

16.67 Mbps Ethernet Extender; 100–240 VAC

2168/L/EUI: Local Extender; RJ45 Line

2168/R/EUI: Remote Extender; RJ45 Line

2168/L/TB45/EUI: Local Extender; RJ45 Line + Terminal Block

2168/R/TB45/EUI: Remote Extender; RJ45 Line + Terminal Block

16.67 Mbps Ethernet Extender Kit; 100–240 VAC

2168/EUI-2PK: Local & Remote Extenders; RJ45 Line

2168/TB45/EUI-2PK: Local & Remote; RJ45 Line + Terminal Block

Environmentally Hardened 16.67 Mbps CopperLink Ethernet Extender; 100–240 VAC

ET2168/R/UI: Extended Temp -40 to 85°C Remote Extender

EC2168/R/UI: Environmentally Controlled 0 to 85°C Remote Extender

EHA2168/R/UI: Environmentally Hardened 0 to 50°C Remote Extender

16.67 Mbps Ethernet Extender Rack Card

2168RC/L: Local Extender; RJ45/TB line

2168RC/R: Remote Extender; RJ45/TB line



12.5 Mbps CopperLink™ Ethernet Extender

Model 2158

Efficient and cost-effective Ethernet extension over voice-grade wire.



The Patton CopperLink™ Ethernet Extender offers the fastest, most efficient and reliable solution for connecting 10/100Base-TX Ethernet LANs. With a line rate of 12.5 Mbps, the Patton Model 2158 offers premium performance

over your existing voice-grade telephone wire, eliminating the cost of installing new LAN-grade cable or expensive fiber.

CopperLink™ Ethernet Extenders are compact, easy to install, and transparent to higher layer protocols. The CopperLink Ethernet Extenders will auto-sense and configure for 10Base-T or 100Base-TX as well as full or half-duplex Ethernet operation. No configuration is required!

Whether you are looking to make your network connections go farther and faster, increase the efficiency of your existing wiring infrastructure, or just simply extending your LAN, Patton's CopperLink™ Ethernet Extender is one of the most simple and cost-effective solutions around!

FEATURES & BENEFITS

- ✓ Overcomes the 328-ft (100-m) limitations of Ethernet
- ✓ 12.5 Mbps line rate
- ✓ Auto-sensing 10/100Base-TX port
- ✓ Transparent LAN Bridging
- ✓ Supports 802.1 Q VLAN tagging
- ✓ Auto-sensing full or half duplex
- ✓ 100% Plug-and-Play!

Approximate Distances at 12.5 Mbps	
Wire Gauge	Distance
26 AWG (0.4 mm)	3856 feet (1.18 km)
24 AWG (0.5 mm)	4656 feet (1.42 km)
22 AWG (0.6 mm)	5256 feet (1.60 km)
20 AWG (0.8 mm)	5556 feet (1.69 km)
18 AWG (1.00 mm)	5756 feet (1.75 km)
16 AWG (1.29 mm)	5856 feet (1.78 km)

Back-to-Back Extension Application

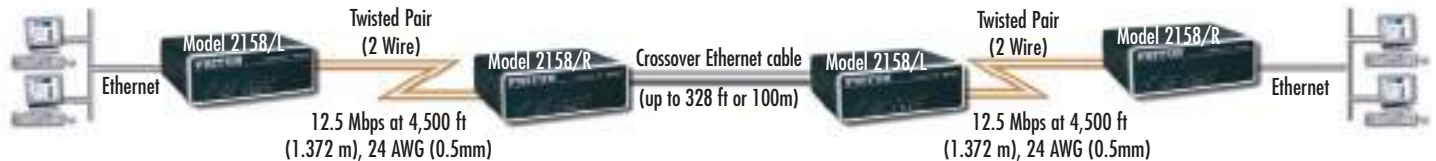

SPECIFICATIONS

CopperLink Interface: RJ-45 (pin 4=TX, pin 5=RX) and two-position terminal block (supports 19–26 AWG)

Ethernet Interface: Shielded RJ-45. Auto-sensing 10/100Base-TX with half or full-duplex operation

Protocol: Transparent to high layer protocols. Supports 802.1Q VLAN tagging

Transmission: CopperLink line rate: 12.5 Mbps; Data rate: 10 Mbps

Surge Suppression: CopperLink maximum current surge: 20kA (8/20µs) gas tube

External Power Supply Options:

- Universal Power Supply (100–240 VAC)
- DC: -48 VDC, -24 VDC, and -12 VDC (optional upon request)

Compliance: FCC Part 15 Class A; EMC Directive 89/336/EEC, Low Voltage Directive 73/23/EEC; CE Mark

Op. Temp.: 32–122°F (0–50°C)

Dimensions:

- Standalone: 1.5H x 4.13W x 3.75D in. (3.81H x 10.5W x 9.53D cm)
- Rack card: 3.0H x 0.83W x 7.84D in. (7.6H x 2.1W x 19.9D cm)

Weight:

- Standalone: 0.4 lbs (0.18 kg) without power supply
- Rack card: 0.3 lbs (0.14 kg) with rear card

ORDERING INFORMATION

12.5 Mbps CopperLink Ethernet Extender

2158/L/EU: Local Extender; RJ45 Line; 100–240VAC

2158/R/EU: Remote Extender; RJ45 Line; 100–240VAC

12.5 Mbps CopperLink Ethernet Extender Kit

2158/EU-2PK: Local & Remote Extenders; RJ45 Line; 100–240 VAC

Environmentally Hardened 12.5 Mbps CopperLink Ethernet Extender

EHA2158/UE: Environmentally Hardened (external connector), 0 to 50°C Remote Extender; 100–240 VAC

Rack Card 12.5 Mbps CopperLink Ethernet Extender

2158RC/L: Local Extender; RJ45/TB line

2158RC/R: Remote Extender; RJ45/TB line

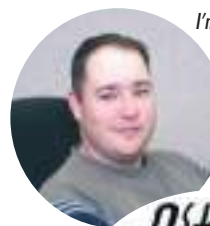

I'm John, one of Patton's Ethernet Extenders Product Group Managers. If you do not find what you need at www.patton.com or in this catalog please call me at +1 301.975.1000, x160. You can also send e-mail to jgrant@patton.com.



2.3 & 4.6 Mbps CopperLink™ Ethernet Extenders with Auto-Rate Adaptation

Models 2156 & 2157

High speed/long-distance LAN extension over copper wires.

LAN extension doesn't have to be expensive or difficult. The Auto-Rate Adaptive LAN Extenders are easy to use and take advantage of the existing copper twisted-pair infrastructure to connect LANs at rates up to 4.6 Mbps.

Whether it's connecting corporate LANs or remote offices, the CopperLink is the simple solution for ensuring the best combination of speed and distance in the industry. Many LAN extenders are set for a single rate, or require difficult configurations in order to connect LANs at different distances. With its auto-rate adaptation feature, the Models 2157 and 2156 ensure that users get the highest speed possible for the distances they are trying to reach. To make it even simpler to use, the Models 2157 and 2156 come with a built-in MDI-X switch to allow easy connection to LANs or PCs with no need for worrying about whether you



have a cross-over cable or not. Setup consists of connecting the Ethernet port, connecting the copper twisted pair, and powering up the units!



ORDERING INFORMATION

2156/L/EUI: CopperLink Ethernet Extender, (Local unit), 90–260 VAC UI

2156/R/EUI: CopperLink Ethernet Extender, (Remote unit), 90–260 VAC UI

2156/EUI-2PK: CopperLink Ethernet Extender, (Local and Remote units), 90–260 VAC UI

2157/L/EUI: Auto-Rate CopperLink Ethernet Extender, (Local unit), 90–260 VAC UI

2157/R/EUI: Auto-Rate CopperLink Ethernet Extender, (Remote unit), 90–260 VAC UI

2157/EUI-2PK: Auto-Rate CopperLink Ethernet Extender, (Local and Remote units), 90–260 VAC UI

FEATURES & BENEFITS

- ✓ Auto-rate adaptation gives the highest rate possible for the extension distance of your network
- ✓ Model 2156: 2.3 Mbps over just a single twisted pair of copper
- ✓ Model 2157: 4.6 Mbps over just a single twisted pair of copper
- ✓ Extension distances up to 32,000 feet (10 km)
- ✓ Auto-sensing 10/100 Ethernet port
- ✓ Integrated MDI-X switch to allow easy connection to any computer or LAN
- ✓ Auto-sensing full or half-duplex operation
- ✓ Support for 802.1 Q VLAN tagged packet transmission

SPECIFICATIONS

Protocol: Transparent to higher layer protocols. Supports 802.1 Q VLAN tagged packet transmission

Transmission Line: Single twisted pair

Line Rates: 2156: Auto-Rate adaptive from 64 kbps to 2.3 Mbps • 2157: Auto-Rate adaptive from 64 kbps to 4.6 Mbps

DTE Rates: 2156: All 64k steps from 64 to 2304 kbps • 2157: All 64k steps from 64 to 4608 kbps

Line Coding: TC-PAM

LED Status Indicators: WAN: Link, TD, RD, Ethernet: Link, 10/100, TD, RD, Power

Connectors: RJ-11 on copper line side, RJ-45 for Ethernet connection, shielded male IEC320 power connector.

Power: External 90–260 VAC, 50–60 Hz (Universal Input), 10 W external 40–60 VDC, 10W (DC option)

Line Interface: Transformer coupled, 1500 VAC isolation.

Compliance: FCC Part 15, CE Mark per EMC directive 89/336/EEC and Low Voltage Directive 73/23/EEC, UL1950 UL and cUL listed (Rev A: Listing in process)

Op. Temp.: 32–122°F (0–50°C)

Humidity: 5–95%, non-condensing

Altitude: 0–15,000 ft (0–4,600 m)

Dimensions: 7.3 x 6.6 x 1.62 in. (185 x 168 x 41 mm)

Weight: 2.0 lbs (1.0 kg)

Corporate Campus application

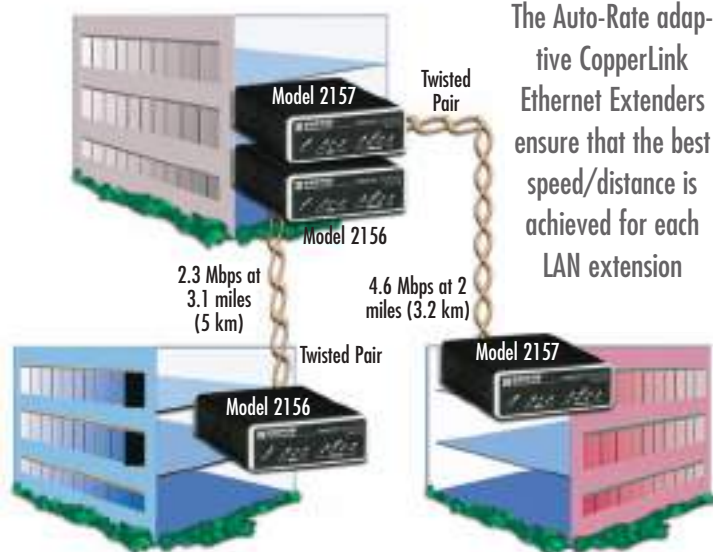

Models 2156 & 2157 Extension Distances

DSL line rate	No Noise										
	26g (0.4 mm)		24g (0.5 mm)		22g (0.6 mm)		20g (0.8 mm)		19g (0.9 mm)		
N	kbps	miles	km	miles	km	miles	km	miles	km	miles	km
3	200	4.4	7.2	5.7	9.4	8.0	13.1	10.3	16.8	12.1	19.7
6	392	4.0	6.6	5.4	8.8	7.5	12.3	8.7	15.8	10.8	17.5
8	520	3.8	6.2	5.1	8.3	7.1	11.6	9.2	14.9	9.7	15.8
12	776	3.5	5.6	4.6	7.5	6.0	9.8	7.8	12.7	8.8	14.3
18	1160	3.0	4.9	4.0	6.4	5.2	8.4	6.7	11.0	7.5	12.3
24	1544	2.8	4.6	3.7	6.1	4.9	7.9	6.4	10.3	6.7	11.0
32	2056	2.5	4.0	3.3	5.3	4.2	6.9	5.6	9.0	5.9	9.6
36	2312	2.3	3.8	3.1	5.0	4.0	6.6	5.3	8.6	5.6	9.1
42	2696	2.3	3.7	3.0	5.0	4.0	6.4	5.2	8.4	5.5	8.9
48	3080	2.2	3.6	3.0	4.8	3.9	6.3	5.0	8.2	5.4	8.7
54	3464	2.1	3.4	2.7	4.5	3.6	5.8	4.7	7.6	4.9	8.8
60	3848	1.9	3.1	2.5	4.1	3.3	5.3	4.3	7.0	4.5	7.4
66	4232	1.7	2.8	2.3	3.7	2.9	4.8	3.9	6.3	4.1	6.6
72	4616	1.5	2.5	2.0	3.3	2.6	4.2	3.4	5.5	3.6	5.9



144 kbps, LAN Extender

Model 2155

The perfect LAN extender for those long haul applications.

There are many applications for long distance LAN extension that do not require ultra-high rates. The Model 2155 is perfect for just those applications. You can connect these modems up to 5 miles (8 km) apart on a single copper twisted-pair without changing the data rate. Just plug them in and power them up, and they take care of the rest. Lots of LAN extenders require you to set up the rate and vary the data rate based on the distance. Not these modems—connect them up and you get the maximum rate at any distance up to their maximum reach of 8 miles (8 km).

The 2155 LAN extenders are completely transparent to higher level protocols, like VLAN tagging, enabling these extenders to fit into almost any location where cost-effective LAN



extension is needed. If there is ever a problem, the easy-to-read LEDs and built-in diagnostics make it a snap to verify operation. When you need the same connection to all your remote LANs, use the Patton 2155.

FEATURES & BENEFITS

- ✓ Extend your network up to 5 miles (8 km)
- ✓ 144 kbps using twisted pair of copper
- ✓ Plug-and-play—No configuration necessary!
- ✓ 10Base-T full or half-duplex Ethernet port
- ✓ Support for 802.1 Q VLAN tagged packet transmission
- ✓ LEDs provide quick status at a glance
- ✓ Test mode switch makes troubleshooting easy
- ✓ Convenient standalone desktop model

SPECIFICATIONS

Data Rate: 144 kbps

Diagnostics: V52 compliant (511/511E) pattern generator and detector with error injection mode and Remote Loopback control by a single front panel switch.

LED Status: Copper Link, 10BT Link, Ethernet Status, No Signal, Error, Test Mode

Power: External desk top transformer, 90–260 VAC, 50–60 Hz (Universal Input), 10 W or –48 VDC; shrouded male IEC-320 power connector

Transmission Line: Single Twisted Pair of Copper

Line Coding: 2B1Q

Line Interface: Transformer coupled, 1500 VAC isolation

Physical Connection: RJ-45, 2 wire, polarity insensitive pins 4 and 5

LAN Connection: RJ-45, 10Base-T 802.3 Ethernet

Protocol: Transparent to higher layer protocols. Supports 802.1 Q VLAN tagged packet transmission

Address Aging: Entries are deleted after 8 minutes of inactivity

LAN Address Table: 4096 MAC Addresses

Frame Latency: 1 Frame

Frame Buffer: 512 Frames

Physical Connection: RJ-45, pin 1 Tx Data +, pin 2 Tx Data -, pin 3 Rx Data +, pin 6 Rx Data -pins 4,5,7,8 no connection

Compliance: FCC Part 15, CE Mark per EMC directive 89/336/EEC and Low Voltage Directive 73/23/EEC, CTR 1, UL1950 UL and cUL listed (Rev A: Listing in process)

Op. Temp.: 32–122°F (0–50°C)

Dimensions: 4.1 x 5.5 x 1.6 in. (105 x 140 x 41 mm)

Weight: 1.6 lbs (0.7 kg)

Typical applications



LAN Extension Using Existing Copper Twisted Pair

2-Wire Distance Table in miles (km)

Data Rate	AWG Wire Gauge (mm)			
	19 (0.9)	22 (0.6)	24 (0.5)	26 (0.4)
All rates	10.8 (17.2)	7.2 (11.5)	7.2 (11.5)	5.0 (8.0)

ORDERING INFORMATION

2155/L/UI: CopperLink 144 kbps Ethernet Extender, (local unit), 90–260 VAC UI

2155/R/UI: CopperLink 144 kbps Ethernet Extender, (Remote unit), 90–260 VAC UI

2155/UI-2PK: CopperLink 144 kbps Ethernet Extender, Local and Remote units), 90–260 VAC UI

IP Network Camera Extender

Model 1173

Patton's plug-and-play IP Network Camera Extender enables users to place IP cameras almost 20 times farther away than the standard distance of 328 ft (100 meters) over standard phone-grade twisted-pair.



The Patton Model 1173 IP Network Camera Extender enables streaming video rates of up to 50 Mbps over ordinary phone grade twisted pair. Unlike wireless, wire-

line extension provides a secure and reliable connection without needing a clear line of sight. Dependable performance and streaming rates up to 50 Mbps, the Model 1173 is the perfect solution for transporting high resolution security video footage.

While the device is plug-and-play, the Model 1173 features three user-selectable settings for line rates providing flexibility in achieving the optimal video resolution-distance combination. The Model 1173 is completely transparent to protocols, codecs, and applications ensuring compatibility with any IP camera and its management software.

SPECIFICATIONS

CopperLink line interface: RJ-45 (pin 4 = ring; pin 5 = tip)

Ethernet interface: 8-position shielded RJ-45. Auto-sensing 10/100Base-T with half or full-duplex operation. DIP switch capable of disabling 100-Mbps full-duplex for equipment that does not support 802.3X (Pause Packets)

Protocol: Transparent to high layer protocol. Supports 802.1Q VLAN tagging

Modulation: Quadrature Amplitude Modulation (QAM) 4-band

Duplexing Method: FDD (Frequency Division Duplexing)

Frequency Range: CopperLink: 0–12 MHz

Transmission: CopperLink line rate: Up to 50 Mbps

Surge suppression: CopperLink line maximum current surge: 20 kA (8/20 µs) gas tube

Front Panel Indicators: Power, Link, Ethernet

Power Supply: External AC and DC options: 120 VAC, and universal input (UI)—100–240 VAC, or optional -48 VDC, -24 VDC, or -12 VDC

Compliance: FCC Part 15A, CE Mark, EMC Directive 89/336/EEC, Low-Voltage Directive 73/23/EEC

Environment: Temp: -10 to 70°C

Humidity

Standard: Up to 90% non-condensing
Conformal Coated: 85% condensing humidity from -10 to 35°C

Dimensions:

1.5H x 4.13W x 3.75D in.
(3.81H x 10.5W x 9.53D cm)

Weight: 0.4 lbs (0.18 kg) without power supply

FEATURES & BENEFITS

- ✓ Extend high resolution IP video up to 6,000 feet (1,829 meters) over telephone-grade twisted-pair cabling
- ✓ Fully compatible with any IP camera and its managing software
- ✓ Fully transparent to compression schemes such as WMV, MPEG-4 and MJPEG
- ✓ Fully transparent to your camera's application software
- ✓ Wall or DIN mountable
- ✓ Plug and Play
- ✓ Operating temperature of -10 to 70°C

Line Rates (AWG 24/0.5 mm)

Mbps	Distance in feet (meters)
4	6,000 (1,830)
16	4,000 (1,200)
50	2,000 (610)

ORDERING INFORMATION

Model 1173R/EUI-2PK: IP Network Camera Extender Kit -10 to 70°C; UI

Model 1173R/C/EUI-2PK: IP Network Camera Extender Kit -10 to 70°C, conformal coated (humidity 85% condensing from -10 to +35°C); UI

USB 1.1 Extender Kit

Model 110

Extends the distance of a USB device to a host computer up to 196 feet (60 m) over Cat5e cable

Patton's Model 110 overcomes USB length limitations of 16 feet so that you have the flexibility to locate your USB printer, camera, web cam or any other USB device where you want them. The Model 110 extends the distance of a USB device to a host computer up to 196ft (60m) over Cat5e. The 110 is plug-and-play with absolutely no special software or drivers to install.

ORDERING INFORMATION

110-KIT: USB Extender Kit

0805XXX: USB Power Supply



FEATURES & BENEFITS

- ✓ Fully compliant with USB 1.1 specifications
- ✓ Provides support for any full speed (12 Mbps) or low speed (1.5 Mbps) USB devices
- ✓ No software required
- ✓ USB LED indicator for quick glance status checks

SPECIFICATIONS

USB: Fully compliant to USB 1.1

Rates: Full speed (12 Mbps)/Low speed (1.5 Mbps)

Connector:

• Local Unit: USB Type A Male; RJ-45

• Remote Unit: USB Type A Female; RJ-45

Active Pins: Power 1 & 4; Data 2 & 3

Distances:

• **Cat 5:** non-powered 98 ft (30m)

• **Cat 5:** powered 165ft (50m)

• **Cat 5e/6:** non-powered 196 feet (60 m)

• **Cat 5e/6:** powered 263 feet (80 m)

Operating temp.: 32 to 104°F (0 to 40°C)

Storage temp.: -40 to 185°F (-40 to 85°C)

See Pg 134



CopperLink™-T T1/E1 Extender

Models 2113 & 2115

This transparent, plug-and-play T1/E1 Extender solves the distance and wire limitations of TDM technology by tripling the reach and halving the number of required wire pairs.



Model 2113

Model 2113 & 2115 T1/E1 Extenders are the perfect choice for enterprises, integrators, and service providers needing to extend T1 and E1 circuits beyond their typical reach while conserving the number of wire pairs used.

With the CopperLink™-T extenders, zero configuration is required. They operate in clear-channel mode, thereby facilitating the transparent extension of data and voice bearing circuits—including the F-bit on T1 circuits. The two active pins on the RJ connector are polarity insensitive, so you don't even need to worry about which wire you connect on the line interface. Simply take them out of the box, put

them on either side of the dry copper pair, connect your T1 or E1 device and the circuit will light up immediately!

The Model 2113 extends E1 circuits to 16,100 feet (4,900 meters, nearly 5 km) while the Model 2115 extends T1 circuits to more than 3.5 miles (18,500 feet or 5,600 meters). Both models require only two wires (one pair) to extend the TDM circuits, thereby conserving and minimizing the copper plant resources used.

For these reasons, the CopperLink™-T extenders are the ideal solution for most popular applications such as T1/E1 backhaul from a remote site, T1/E1 relocation, T1/E1 extension across a campus or between buildings, and last-mile TDM delivery.



Model 2115

FEATURES & BENEFITS

- ✓ Triple the Distance—Extend T1s to over 3 miles and E1s to almost 5 km over one pair of wires.
- ✓ Half the Wires—The T1/E1 extenders only require one pair of wires to operate.
- ✓ Voice and Data Extension—The T1/E1 Extenders operate in clear channel mode allowing the transparent passing of both voice and data.
- ✓ Plug and Play—Plug them in and the link comes up in seconds. The line interface is even polarity insensitive, making it easier to get running.
- ✓ Line Tests—V.52 511/511E Pattern generator with remote digital loopback (RDL); local analog loopback (LAL).
- ✓ Front Panel Status Indicators—Front panel LEDs provide users with quick feedback on unit operation.

SPECIFICATIONS

Circuit Connector: Model 2113 E1 Extender: Dual 75-Ohm female BNC and single 120-Ohm female RJ-48C • Model 2115 T1 Extender: Single female RJ-48C
Supported Line Tests: V.52 511/511E Pattern Generator with RDL; LAL
Clocking: CO unit preset for Network Clock, CPE unit preset for Receive Recover
Line Coding: 16-constellation TC-PAM
Line Interface: Female RJ-11 using pins 2 & 3; Two wires (single twisted-pair)
Front Panel Indicators:
Power—Solid green indicates unit is powered up. Slow blinking indicates unit is in POST. Fast blinking indicates unit failed POST. Dark indicates unit does not have power.

Link—Solid green indicates end-to-end link. Flashing indicates unit is training. Dark indicates link is down.
Frame—Solid green indicates valid framing. Flashing indicates signal being received, but no link established.
Power Supply: External power supply options: Universal 90–260 VAC operating from 50–60 Hz; 120 VAC/60 Hz; 240 VAC/60Hz; -48 VDC
Compliance: FCC Part 15A, CE Mark, EMC Directive 89/336/EEC, Low-Voltage Directive 73/23/EEC
Operating Temp.: 32–122°F (0–50°C)
Humidity: 5–90% non-condensing
Dimensions: 4.7 x 1.52 x 5.0 in. (10.6 x 3.9 x 12.7 cm)

Typical applications



I'm Emily, one of Patton's Electrical Engineers designing CopperLink™ Ethernet Extenders. To buy one of these state-of-the-art devices, call +1 301.975.1000 or send e-mail to sales@patton.com.

ORDERING INFORMATION

- 2113/EUJ-2PK: CopperLink-T, E1 Extender, 2 pack
- 2113/L/EUJ: CopperLink-T E1 Extender, Local unit
- 2113/R/EUJ: CopperLink-T E1 Extender, Remote Unit
- 2115/EUJ-2PK: CopperLink-T T1 Extender, 2 pack
- 2115/L/EUJ: CopperLink-T T1 Extender, Local unit
- 2115/R/EUJ: CopperLink-T T1 Extender, Remote unit

visit us online
www.patton.com

FAST Delivery From Your AUTHORIZED DISTRIBUTOR!





See
Pg 134

Compact Ethernet-over-E1 WAN Bridge

NetLink 2701/I EtherRocket & 2701RC Rack Card

These devices, available in low-cost standalone or rack-mountable versions, terminate G.703/G.704 NTU with on-board transparent Ethernet Bridge extend branch-office LAN segments over E1/FE1 simply and affordably.



Patton Electronics introduces a new way of interconnecting remote branches to a Main Office LAN using the Model 2701/I Ethernet-over-E1 Bridge. Called "Remote Router Porting" (RRP), it offers network managers and integrators a simple and economical way for LAN-to-LAN deployments.

At the branch office, RRP replaces the traditional router and CSU/DSU solution with Patton's Ethernet-over-E1 Bridge, which includes integrated E1 and 10Base-T transparent bridging. This unit allows for high-speed PPP data connections across the Wide Area Network at scalable data rates of nx56/nx64kbps up to 2.048 Mbps, and also connects directly to the 10Base-T branch office LAN at 10Mbps. The 2701/I transparently forwards Ethernet packets to a headquarters LAN based on their destination MAC address.

At headquarters, RRP builds on the bridging capabilities of a router to extend their serial or WAN ports across town or across the country. In order for the central routed network to connect to a remote branch Ethernet network, the serial or WAN interface of the router needs to be configured as a PPP IP half-bridge. In this configuration, the Ethernet-over-E1 Bridge sends bridge packets (BPDU's) to the router's WAN interface. The router will then look at the layer-3 address information and will forward these packets based on its IP address. The router's port, connected through the E1 network and Ethernet-over-E1 Bridge, appears as a virtual interface at the branch office network.

The Model 2701/I Ethernet-over-E1 Bridge supports G.704 framing, and AMI and HDB3 line coding. Data rates, framing, and coding options are programmed by DIP switches or from a VT-100 terminal with menu-driven software. A full range of system and diagnostic features make setup simple and quick.



FEATURES & BENEFITS

- ✓ Terminates E1/Fractional E1 service
- ✓ 10Base-T Ethernet-over-E1 Bridge
- ✓ Available in low-cost standalone or rack-mountable (2701RC) versions
- ✓ PPP (Point-to-Point Protocol, RFC 1661) with BCP (Bridge Control Protocol, RFC 1638)
- ✓ 2 Mbps E1 Line Rate with n x 64 kbps timeslot selection
- ✓ Switch-selectable AMI or HDB3 line encoding options
- ✓ 75-ohm dual coax and 120-ohm twisted-pair G.703 connections
- ✓ Local and remote loopback diagnostics
- ✓ Internal and G.703 network timing
- ✓ Conforms to ONP requirements CTR 12 and CTR 13 for connection to international Telecom networks
- ✓ Rack cards fit into Model 1001 access rack system

ORDERING INFORMATION

2701/I/U: G.703/G.704 NTU, Ethernet interface; 120–220 VAC PS

2701/I/48: G.703/G.704 NTU, Ethernet interface; 48 VDC power supply (PS)

2701RC/A/I: G.703/G.704 NTU Card, V.35 interface

2701RC/C/IA: G.703/G.704 NTU, Ethernet/RJ-45 interface

2701RC/D/D: G.703/G.704 NTU Card, X.21 interface

2701RC/D/V: G.703/G.704 NTU Card, X.21 interface

Remote Router Porting with Patton's Ethernet-over-E1 Bridge



SPECIFICATIONS

2701/I

Line Rate: 2 Mbps with nx64 kbps timeslot selection

Network Connector: RJ-48C and Dual Coaxial

DTE Interface: 10Base-T Ethernet

Line Coding: AMI or HDB3

Line Framing: G.703 (unframed) or G.704/G.732 (framed)

Clocking: Internal or Receive Recover

DTE Rates: 10 Mbps (10Base-T)

Indicators: E1 Link Status, TD, RD, Loss of Sync, Error, Test Mode, Ethernet Status

Diagnostics: Local/Remote Loop, 511 pattern

Line Isolation: 1500VRMS

Compliance: CE Mark, G.703, G.704, G.723, G.832, CTR-12 and CTR-13

Environment: Temp.: 32–122°F (0–50°C) • Humidity: 5–90% non-condensing

Dimensions: 5.84L x 4.16W x 1.51H in. (14.84L x 10.6W x 3.84H cm)

Weight: 2.225 lbs (1.02 Kg)

2701RC

Data Rate: Smooth Clock 2.048 Mbps

Network Connector: RJ-48C (all versions); Dual Coaxial (X.21 & Ethernet)

DTE Interface: EIA-530, X.21/V.11, V.35, or 10Base-T Ethernet

Line Coding: AMI or HDB3

Line Framing: G.703 (unframed) or G.704/G.732 (framed)

Clocking: Internal, External or Receive Recover

DTE Rates: nx64kbps (EIA-530, X.21/V.11, V.35); 10Mbps (10Base-T)

Indicators: E1 Link Status, TD, RD, Loss of Sync, Error, Test Mode, Ethernet Status (on 10Base-T Version)

Diagnostics: Local/Remote Loop, 511

Line Isolation: 1500VRMS

Compliance: CE Mark, G.703, G.704, G.723, G.832, CTR-12 and CTR-13

Environment: Temp.: 32–122°F (0–50°C) • Humidity: 5 to 90% non-condensing

Dimensions: 5.84L x 4.16W x 1.51H in. (14.84L x 10.6W x 3.84H cm)

Weight: 2.225 lbs (1.02 Kg)

Ethernet MicroBridges (X.21, RS-232, RS-530, & V.35)

Models 2121, 2124, 2130, 2135, & 2135C

Patton's MicroBridge products are the cost-effective solution for expanding your LAN—without using a router!



The Patton Ethernet MicroBridge provides a cost-effective solution for connecting multiple local or remote network segments. The Patton MicroBridges feature a wide variety of serial interfaces to make your WAN connections easy. All models are equipped with an 802.3 10Base-T Ethernet RJ-45 jack, which allows a direct connection to your network equipment.

The Ethernet MicroBridge works on the MAC-layer addresses and operates independent of higher layer protocols. This functionality enables Patton Ethernet MicroBridges to pass higher-layer broadcast, multicast, unicast, and data frames over the WAN with minimal to no configuration by the end-user. The MicroBridges are PPP ready supporting standards based layer-2 protocol interfacing. The MicroBridges are fully compatible with each other as well as Patton's full line of bridging products. Using PPP, the MicroBridges have the flexibility to be used in conjunction with all other third-party PPP compliant equipment.

Whether you are looking to add additional LANs, increase the efficiency of your WAN connection, or extending your router's interface, Patton's Ethernet MicroBridge is the most simple and cost-effective solution around!

FEATURES & BENEFITS

- ✓ PPP Bridging Control Protocol (RFC 1638) with auto detection for compatibility with existing Patton Bridge Products and standard third-party equipment
- ✓ Transparent LAN bridging enables the MicroBridge to pass higher layer protocols and VLAN tagged frames.
- ✓ Industry standard, shielded RJ-45 Ethernet connection
- ✓ 802.3 Ethernet supported by transparent LAN bridging
- ✓ 1 Mbyte RAM; 128 kbyte FLASH
- ✓ Automatic learning and aging with support for up to 4,096 MAC addresses
- ✓ Nine LEDs monitor power, LAN link, and DTE interface signals
- ✓ Variety of WAN interfaces available (X.21, RS-232, RS-530, and V.35)
- ✓ Transparent to VLAN.Q tagged packets

ORDERING INFORMATION

2121/DM-X/UI: Ethernet MicroBridge, X.21 DTE with DB-15 Male, Serial Cable, 100–240 VAC

2121/DM-X/48: Ethernet MicroBridge, X.21 DTE with DB-15 Male, Serial Cable, -48 VDC

2124/AM-X/UI: Ethernet MicroBridge, V.24 DTE with DB-25 Male, Serial Cable, 100–240 VAC

2124/AM-X/48: Ethernet MicroBridge, V.24 DTE with DB-25 Male, Serial Cable, -48 VDC

2130/BM-X/UI: Ethernet MicroBridge, EIA-530 DTE with DB-25 Male, Serial Cable, 100–240 VAC

2130/BM-X/48: Ethernet MicroBridge, EIA-530 DTE with DB-25 Male, Serial Cable, -48 VDC

2135C/CM-X/UI: Ethernet MicroBridge, V.35 DTE with M/34 Male, Serial Cable, 100–40 VAC

2135C/CM-X/48: Ethernet MicroBridge, V.35 DTE with M/34 Male, Serial Cable, -48 VDC

2135/CM/UI: Ethernet MicroBridge, V.35 DTE with M/34 Male (No Serial Cable), 100–240 VAC

2135/CM/48: Ethernet MicroBridge, V.35 DTE with M/34 Male (No Serial Cable), -48 VDC

Note: X = "L" 6-foot (182.88cm) Serial Cable or "S" 6-inch (15.24cm) Serial Cable. **Example:** 2121/DM-S/UI Ethernet MicroBridge, X.21 DTE w/DB-15 Male, 6" (15.24cm) Serial Cable, UI

Remote Router Porting

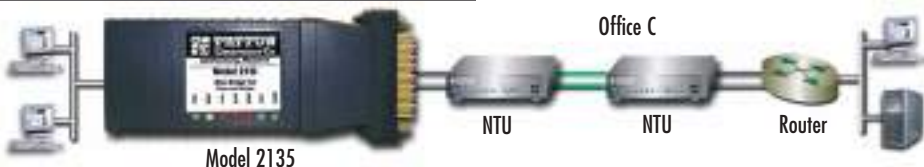

Patton's Ethernet MicroBridge Series are compliant with the RFC 1661 standard for PPP half-bridging, so you can connect our bridge to a router (instead of another bridge) which saves you money!

SPECIFICATIONS

DTE Interface: X.21, V.35, RS-232, or RS-530

Network Interface: IEEE 802.3 10Base-T (RJ-45)

Transmission: Synchronous up to 10 Mbps

Protocol: PPP (RFC 1661) with Bridging Control Protocol (RFC 1638)

Memory: 1MB RAM, 128KB FLASH memory

MAC Address Table Size: 4096 entries

MAC Address Aging: MAC addresses deleted after eight minutes inactivity

LEDs LAN Side: (1) yellow, general status; (1) green, link integrity

LEDs DTE Side: TXD, RXD and Power, (green); DTR, DCD, CTS and CLK, (yellow)

Power Supply Input: 100–240 VAC, 50–60 Hz, 0.4A; or optional -48 VDC

Power: 500mA at 5 VDC

Temperature: 32–122°F (0–50°C)

Altitude: 0–15,000 ft (0–4,572 m)

Humidity: Up to 90% R.H., non-condensing

Dimensions: 3.5 L X 2.1 W X 0.78 H inch (9.0 L X 5.3 W X 2.0 H cm)

Weight: 0.72 lbs (0.32 kg)

Compliance: FCC Part 15A; CE Mark per EEC Directive: 89/336/EEC; Low Voltage Directive: 73/23/EEC

Transmission

Copper Solutions for Network Extension

DSL Flavor	VDSL	G.SHDSL ATM	G.SHDSL TDM	IDSL	Services
Line Rates	16 Mbps	2.3 Mbps	4.6 Mbps	144 kbps	ATM
Distance	1 mile (1.6 km)	3.0 miles (4.9 km)	3.0 miles (4.9 km)	5 miles (8.1 km)	FR
Edge Solutions	3324 (pg 82)	ForeFront (pg 77)	3224 (pg 80) ForeFront (pg 74)	3092 (pg 94)	IP
CPE Solutions	1058 (pg 91) & 1068 (pg 92)	3201 (pg 89), 3086FR (pg 87), FR (pg 83) & 3087 (pg 87)	3201 (pg 89), 3086 (pg 86) & 3088 (pg 84)	1092 (pg 95) & 1082 (pg 96)	Leased Line Voice
Copper					TDM
Network					

NETLINK™ DSL Choose from G.SHDSL and IDSL — along with T1/E1 NTUs — and get the right user interface for your network. The NetLink system provides a variety of CPE options — from compact CPE with fixed interfaces to flexible *QuikConnect™* interfaces. Central office solutions range from 1U high rack-mount TDM concentration units to 2U one-card-per-subscriber rack solutions with flexible front and rear card swappability. It's so easy you will wonder how you ever managed without Patton's NetLink system.



NetLink DSL Products
Page 94–97

FOREFRONT™ DSL Patton's ForeFront™ Access Infrastructure Solutions provide DSL solutions in a scalable carrier-class access platform. With a variety of card styles to provide TDM or IP concentration options and their ability to be mixed and matched in any of the cPCI chassis available, the ForeFront DSL platform gives users a solution to answer their DSL needs now and into the future. Harness the explosive growth of DSL with a tightly integrated, cost-effective solution to aggregate high speed traffic while gaining flexibility and protecting your investment.



ForeFront DSL, Page 70–78

VDSL The low cost solution for truly high bandwidth demands. Patton's VDSL offers the fastest technology available today over copper twisted-pair. With symmetric data rates up to 16 Mbps, Patton's VDSL solutions address the bandwidth needs for video-on-demand, broadcast TV, high speed data exchange, and voice services. Available in many versions, the Patton product line includes multi-rate asymmetrical/symmetrical standalone and rack card modems, fixed-rate standalone and rack card modems, and a VDSL access concentrator.



VDSL
Page 98

Your First Choice for the Last Mile

Network Termination

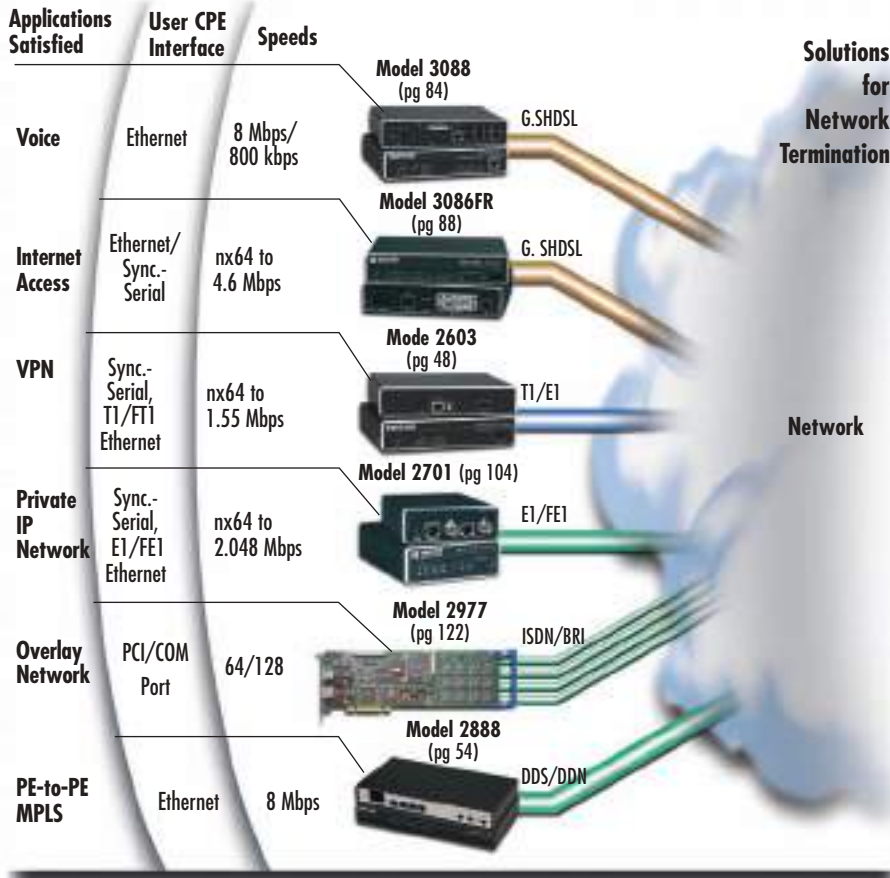

In This Section

DSL Solutions	66
Integrated DSL Access Infrastructure	68
ipDSLAMs	78
G.SHDSL CPE	82
VDSL CPE	89
IDSL CPE	92



Patton EtherRockets: A New Kind of T1 and E1 Converters

- Uses Remote Router Porting™ to transparently extend Ethernet over T1/E1 lines
- Terminates T1/E1 Services
- Nx56/64 speeds to 1.554 Mbps and 2.048 Mbps
- Totally plug-and-play
- 75-ohm and 120-ohm (E1), 100-ohm (T1) connections



Branch Office



Call today to get your free whitepaper on Remote Router Porting and learn how you can save on your next T1 or E1 deployment.

Channelized Gigabit T1/E1 Router

Patton's IPLink Model 2884 multimedia routers concentrate up to 124 WAN connections or bond up to 4 T1/E1s for an 8-Mbps link to serve high-density and bandwidth hungry applications.



DSL Solutions

TDM Concentration

Standalone Functionality					Central Site Systems				
DSL Transport	Sync. Serial	T1/E1	Bridged Ethernet	Routed Ethernet	Access Rack	TDM Concentration	IP Concentration	Models	Page
IDSL	Yes	64K G.703 Only	Yes		Yes	Yes	Yes	1082 Standalone	96
								1092 Standalone	95
								1092 Rack Cards	95
								3092 IDSL-DACS	94
G.SHDSL TDM	Yes	Yes	Yes	Yes	Yes	Yes	3088 Standalone	84	
							3088RC Standalone	51	
							ForeFront Access System	70-78	
G.SHDSL	Yes	Yes	Yes	Yes		Yes	3201 G.SHDSL Router	89	
							3086 G.SHDSL	86	
							3224 G.SHDSL Access Server	80	
							ForeFront DSL Access System	70	
ADSL2+			Yes	Yes			Yes	3101RC	76
VDSL			Yes		Yes		Yes	1058 Standalone	91
								3324 Access Concentrator	82



**EnviroNET™
EH Series**
Environmentally
Hardened



**EnviroNET™
EC Series**
Environmentally
Controlled



**EnviroNET™
ET Series**
Extended
Temperature

Extended Temperature -40 to 85°C allows CPEs to operate in environments that do not have heating or cooling options.

NEMA 4 (IP65) enclosure protects against elements such as dirt, rain, sleet, snow, dust, and the external formation of ice on the enclosure.



Page 144

xDSL CPEs

- IDSL
- G.SHDSL
- VDSL

Access Rack

IP Concentration

One Card per Subscriber



1001 Rack

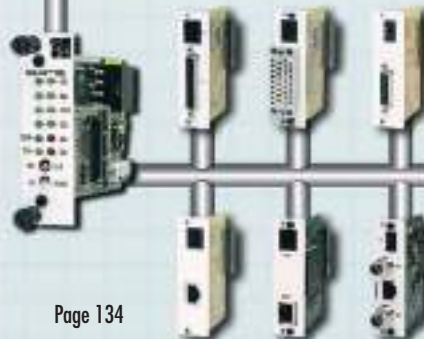

Page 134

The model 1001 rack system gives users port-by-port flexibility in a 2U-high 19-in. rack-mount chassis. Supporting up to 16 cards per chassis, the user can choose from IDSL, G.SHDSL, HDL, VDSL, T1/FT1, E1/FE1, G.703/G.704, or Baseband modem cards. Our unique midplane design enables users to mix and match not only the transmission technology, but also the interfaces used. Add in management cards, AC/DC redundant power supplies and you have a truly flexible solution for systematically expanding your network.



Everything Over DSL

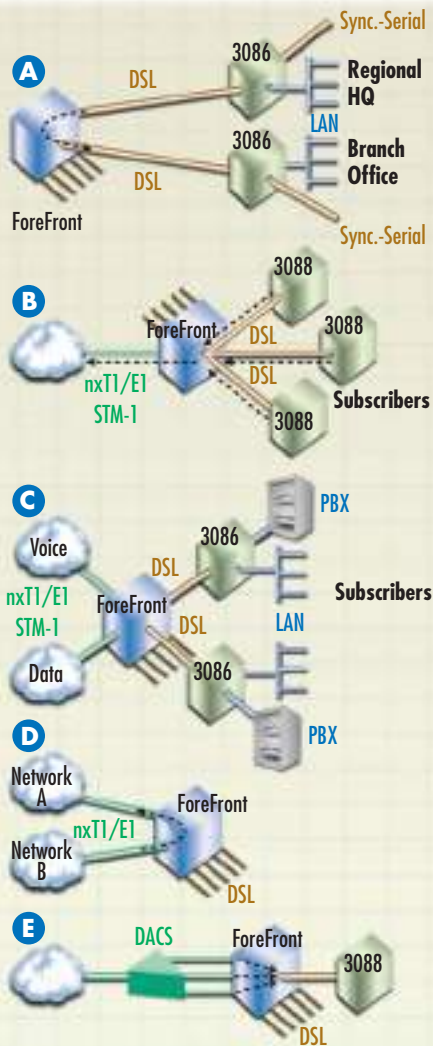

A Metro Area Leased Line

Connect two local sites by mapping DSOs (cross-connect) of one G.SHDSL port to another G.SHDSL port at the ForeFront chassis.

B DSL Concentration

Concentrate data from many DSL links into a few cost-effective uplinks by mapping the DSOs from multiple G.SHDSL ports into the DSOs of the WAN uplink ports.

C Voice/Data DSO Segmentation

To separate or *segment* different types of data (to separate voice from data transmission, for example), map DSOs of specific data types to specific WAN.

D DSL plus T1/E1 DACS

In addition to DSL, map any of the WAN timeslots back to any other WAN timeslot for flexible T1/E1 cross-connecting.

E DACS Pass-Thru

Effectively bypass the cross-connect feature and directly map a single DSL port to a T1/E1 WAN port on a one-to-one basis.

In This Section

DSL Solutions 68

Integrated DSL Access Infrastructure 70

ForeFront Solutions for DSL	71
ForeSight™ NMS	72
G.SHDSL Line Card	74
IDSL Line Card	75
ADSL2+ Triple-Play Access Line Card	76
Router Line Card	77
Matrix Switch Line Card	78

ipDSLAMs 80

High-Speed G.SHDSL Concentrator for IP Traffic	80
VDSL Access Concentrator/Switch	82

G.SHDSL CPE 84

Low-Cost, High-Speed G.SHDSL Modem	84
G.SHDSL FRF.5/FRF.8 over ATM NTU	85
G.SHDSL Integrated Access Device	86
ipRocketLink™ Serial G.SHDSL	87
G.SHDSL FRF.5/FRF.8 over ATM IAD	88
G.SHDSL High-Speed Router	89
G.SHDSL.bis Business Router	90

VDSL CPE 91

VDSL Data & Voice Modems	91
Variable-Rate VDSL Modems	92

IDSL CPE 94

IDSL DACS Provides Quad T1/E1 & 24 IDSL Ports	94
2B1Q Encoding, 2 or 4-Wire Baseband Modem	95
IDSL Modems with V.35, X.21, or 10Base-T (Ethernet) Interfaces	96
High-Speed Serial Extender & RS-232 Serial Extender	97



DSL Concentrator with Routed End-Points for IP Overlay Networks

Patton's ForeFront system provides high level DSL concentration of IP traffic across SDH, SONET, or ATM networks. Providing routed end-points and high speed nxT1/E1 and/or STM-1 egress.

Routed End-Points

Models 3201 & 3086 provide integrated IP routing. The 3086, with its FlexIP software, provides IP routing and sync. serial interfaces on the same unit.



DSL Access Servers for IP Backbones

Patton makes IP concentration easy with high density 1U-high integrated chassis solutions. They provide everything you need in 1U — modems, uplink, router engine, redundant power supplies, management, and advanced routing features.

ForeFront Solutions for DSL

Half-Pipe, Full-Pipe, and Xtreme delivery platforms for DSL

The ForeFront AIS brings next-generation access to your DSL network.

Patton's ForeFront Access Solutions for DSL address the new point-of-presence requirements demanded by today's providers. Using a modular approach, the ForeFront AIS includes all system components needed to provide DSL

access. With multiple chassis options, card configurations and the CPE to go with it, the ForeFront AIS is the solution of choice for your next network expansion!

FEATURES & BENEFITS

- ✓ Up to 288 ADSL2+ ports per chassis
- ✓ Up to 208 G.SHDSL ports per chassis
- ✓ T1/E1, STM-1 WAN egress options
- ✓ The ForeFront Full-Pipe—configured with 3096RC T-DACs—provides up to 128 G.SHDSL links in a 4U chassis. E1 or STM-1 interface options make data network integration a snap. Combined with Patton's 3086 CPE, it provides the complete solution.
- ✓ Redundant AC or DC



Major Components

A Router Cards

The Model 6081RC EdgeROUTE is an Access Server for the ForeFront AIS that is optimized for IP routing and VLAN aggregation. With ample support for MAC address filtering, VLAN priority, and VLAN tagging of individual streams, the EdgeROUTE is a perfect solution for integrating TDM and IPDSLAM traffic into core and edge MPLS networks.

B G.SHDSL Line Cards

Patton has combined G.SHDSL ports, DACs, and WAN functions in a single card. The Model 3096RC TDM-Digital Access Concentrator links 16 G.SHDSL circuits to multiple WAN uplink modules and offers completely flexible any-to-any grooming. Each 2.3-Mbps port offers user-selectable nx64 data rates. With its built-in cross-connect, each data channel, or channel group, can be multiplexed onto any uplink or DSL port—even to ports on other 3096RC blades in the same chassis. With an integrated SNMP/HTTP-based NMS, the entire system is easily manageable.

Each 2.3-Mbps port offers user-selectable nx64 data rates. With its built-in cross-connect, each data channel, or channel group, can be multiplexed onto any uplink or DSL port—even to ports on other 3096RC blades in the same chassis. With an integrated SNMP/HTTP-based NMS, the entire system is easily manageable.

C 6511 Matrix Switch

The Patton Model 6511 Matrix Switch is an integrated multimedia switching engine complete with a digital access cross-connect, high speed STM-1 trunk interface, wire-speed Ethernet packet switch, and GUI management system. The Model 6511's flexible channel switching fabric allows non-blocking switching from any input to any output. The channelized STM-1 interface integrates into a SDH/SONET network, enabling users to channelize an STM-1 down to 64 kbps timeslots. With full grooming capability the Model 6511 Matrix Switch allows any-to-any TDM mapping and can place any channel from any card onto any port.

D ADSL Line Cards

The Patton Model 3101RC provides up to 48 ADSL2/2+ ports of triple-play access, supporting extended reach and higher downstream bandwidth up to 24 Mbps.

The Model 3101RC delivers affordable ADSL/ADSL2/2+ network access for triple-play ready ADSL service. The ADSL2+ IPDSLAM module, together with Patton's ForeFront Access Platform, is the premier solution for fault tolerant Triple-Play enabled network deployments.

The Model 3101RC offers complete ADSL, ADSL2 and ADSL2+ support including extended range operation and enhanced speeds. Each 3101RC IPDSLAM Module includes all the intelligence necessary to function as a complete single card IPDSLAM thereby providing unparalleled redundancy and fault tolerance in network deployments.

ForeFront™ Solutions Center

The ForeFront DSL solutions are made to specifically match the needs of your network. They are easily configurable to meet your uplink needs, your DSL needs, and more. The example systems below show some of the limitless options available with the ForeFront DSL solutions.

The Xtreme

This example comprises two independent STM-1 uplinks, 208 G.SHDSL modems with built-in SNMP management, power supplies, alarm cards, and cooling. The Xtreme's specially designed high speed backplane (with integrated H.110 and 2.16 Ethernet buses) allows mapping of any DSO timeslot to any other DSO timeslot, whether it is DSL, T1/E1, or STM-1. If this isn't enough, you can easily upgrade the Xtreme with two redundant STM-1 ports and up to a total of 208 T1/E1 WAN ports.



The Full-Pipe STM-1

This high density solution gives users 96 G.SHDSL modems and an STM-1 uplink card, along with the integrated features that are standard in the ForeFront solutions, such as built-in DACS, SNMP management, power supplies, alarm cards, and cooling.

The Full-Pipe T1/E1

For those who want a high density solution, but don't have access to an STM-1 uplink, the Full-Pipe also comes with T1/E1 uplinks. Choose how many you want—from 4 to as many as 96 T1/E1 uplinks can be used in the Full-Pipe. Plus, when you are ready for the STM-1, just add the card—the Full-Pipe is ready to go.



The Half-Pipe

If you are ready to start deploying DSL and want to start slow but with a system that will grow as your needs grow, choose the Half-Pipe. This solution is small but powerful—it packs an impressive 64 G.SHDSL modems, DACS, management, supplies, cooling, and 16 T1/E1 WAN ports (upgradeable to 64) into a 2U-high chassis. In addition, as your needs grow and you move to a larger system, the cards will move right along with you to either the Full-Pipe or the Xtreme systems. Ensuring that your investment pays dividends well into the future.



ForeFront cPCI

Configured chassis systems for ForeFront

FEATURES & BENEFITS

- ✓ CompactPCI Open System—Flexible, standards-based, rugged design ensures that it will be a reliable viable platform well into the future.
- ✓ 2U, 4U, 6U Platforms—Get 4, 8, or 17 slots for any system card and scale your deployment.
- ✓ Universal AC or Telco DC power modules offer high power with full 1+1 or N+1 redundancy
- ✓ Integrated management module monitors fan tachometers, voltage, and temperature.

ForeFront chassis solutions



ORDERING INFORMATION

ForeFront Chassis Systems: The ForeFront models below are our most popular configurations. Each is loaded with redundant AC, DC, or mixed AC/DC power supplies, fan modules, and alarm cards. Just add your choice of STM-1 and/or DSL modules to complete your system.

Half-pipe 4-slot chassis with fan module, alarm card, redundant power supplies, & H.110 backplane

6276/RUI: Universal AC supplies

6276/R48: Universal DC supplies

6276/U48: Universal AC/DC supplies

Full-pipe 8-slot chassis with fan module, alarm card, redundant power supplies, and 2.16 backplane

6476/RUI: Universal AC supplies

6476/R48: Universal DC supplies

6476/U48: Universal AC/DC supplies

Xtreme 17-slot chassis with fan module, alarm card, redundant power supplies, and 2.16 backplane

6676/RUI: Universal AC supplies

6676/R48: Universal DC supplies

6676/U48: Universal AC/DC supplies

ForeSight™ NMS

Model 6300 FCAPS EMS

The ForeSight™ Model 6300 is a scalable Element Management System for full life-cycle network management of user services in TDM and routed networks.

The Model 6300 NMS offers integrated FCAPS element management features on a stable Linux platform for full life-cycle network management. The FS6300 scales from a single local server to a distributed, hierarchical multi-station plan with complete redundancy for fail-safe operation. Full life-cycle network management begins with planning the network provisioning to analyzing performance for timely extension of network infrastructure and services. The hierarchical topology of networks is traversed visually via the network tree and main graphical display. Administrators and operators can roam from the top-level "Network" through Areas, Nodes, Chassis, and Cards down to the port level, as the management task dictates. By dividing the networks into separate management domains, the operators are given credential-based visual access.

The integration and design of the FS6300 exceeds the simple aggregation of FCAPS features. The modular management falls under the standardized categories of FCAPS to manage Faults, Configuration, Administration/Accounting, Performance, and Security. These five categories are integrated to function as more than independent units, but to

enforce the discipline of properly documented planning and provisioning directly in the NMS. A major advantage with the integration into a single system minimizes the errors and inefficiencies from duplicate efforts.

Configuration Management begins with planning resource provisioning, then the deployment of equipment, and subsequently auto-discovery of installed nodes. Schedule automatic software upgrades at low traffic times for selective sites or network areas without having to reconfigure each card again. Configuration changes can be executed at any authorized network station to upgrade a client's service or disconnect for clients not maintaining their service contract.

"FCAPS+" Management

Accounting/Administration Information is secured in the network database. Resource administration and client accounting can be grouped into domains for easing these management tasks and increasing the security level of protection. A containment tree view enables an operator to quickly browse the entire inventory.

FEATURES & BENEFITS

- ✓ **Integrated FCAPS**—By integrating the 5 modular FCAPS management tasks, network management efficiency increases while easily enforcing good network management techniques.
- ✓ **Scalable NMS**—The original NMS is built from the basic building blocks of Linux platform for small enterprise network for cost-effective and technically easy NMS growth to large multi-tiered carrier networks.
- ✓ **Configuration Management**—Support good network planning techniques and efficient deployment of new sites and client services. Includes resource provisioning, auto-discovery, and scheduled software image upgrades.
- ✓ **Alarm Management**—Simplify event and alarm management with alarm correlation, filtering and triggers for specific actions, like sending a page or email.
- ✓ **Security Management**—Increase security by dividing the network into mutually exclusive domains assigned to specific operators. Credential-based visual access. Management sessions are secured locally or via remote clients.
- ✓ **Administration Management**—Keep client information in a secured database. Manage equipment resources and client services which can be grouped into domains. Back-up and restore configurations.
- ✓ **Performance Management**—Data collection and presentation is essential for maintaining SLAs and the pre-planning required for future network growth. Print custom reports, save electronic copies of reports, monitor real-time graphical displays of desired network parameters.

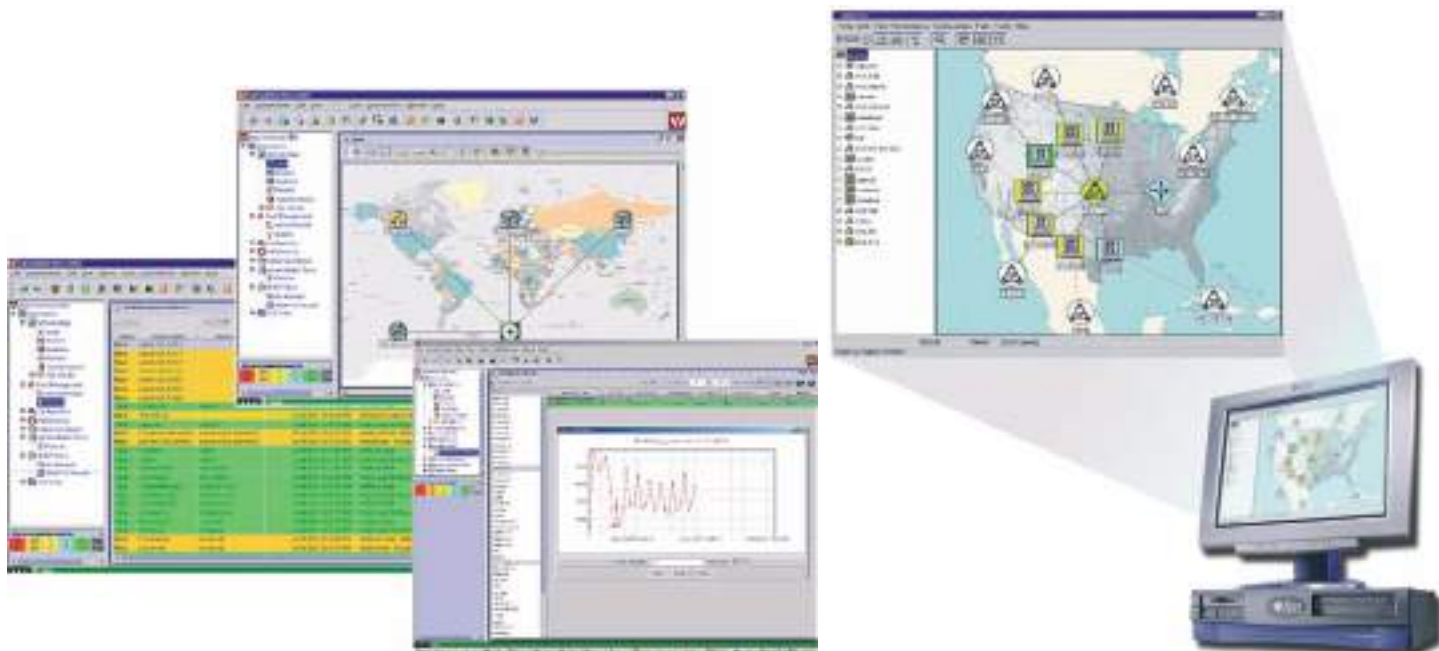

6300 ForeSight Web NMS Editions			
	FS6300/LX (Local)	FS6300/DX (Regional)	FS6300/EX (Regional)
Size of managed networks	≤ 10,000 managed interfaces	≤ 100,000 managed interfaces	100,000 managed interfaces
Maximum number of concurrent clients	5	10 per Front End Server	10 per front end server
Supported Databases*	MySQL	MySQL	MySQL

* Contact marketing if other databases must be supported.

Supported Features			
	FS6300/LX	FS6300/DX	FS6300/EX
Topology maps	Yes	Yes	Yes
Auto-discovery	Yes	Yes	Yes
Configuration Management	Yes	Yes	Yes
Fault (Alarm/Event) Management	Yes	Yes	Yes
Security Management	Standard (limited) Full (optional)	Yes	Yes
Administration/Accounting Management	No	Yes	Yes
Performance Management	No	Yes	Yes
Reports	Yes	Yes	Yes
Provisioning	No	Yes	Yes
Fall-over	No	Yes	Yes
Database redundancy	No	Yes	Yes
Distributed Front-End Server/Load Balancing	No	Yes	Yes
Backup & Restore	Yes	Yes	Yes
SNMP	Yes	Yes	Yes
CORBA	Yes	Yes	Yes
CLI	Yes	Yes	Yes

Supported Operating Systems			
	FS6300/LX	FS6300/DX	FS6300/EX
NMS Server	Fedora Core 6,	Fedora Core 6,	Fedora Core 6,
Remote Application Clients	Windows NT4 / 2000 / XP	Windows NT4 / 2000 / XP	Windows NT4 / 2000 / XP

The ForeSight 6300 Network Management System scales from small enterprise networks to large carrier networks. Providing a *la carte* selection of the NMS components gives the network managing organization the maximum in planning and growing the NMS. As more front-end servers and application clients are added, the NMS can expand from a flat to a multi-tiered hierarchical, mutually exclusive domain-oriented architecture. Distributed and redundant databases implement robustness in operation and also in fail-over scenarios to avoid the loss of data and management capability.

Use the NMS to support the pre-planning phase through deployment of network elements and client network services to future planning of anticipated network growth. By integrating these phases, the NMS goes well beyond standard FCAPS management as it covers the network management's entire life-cycle. A further benefit is to ease the enforcement of good network discipline in designing, provisioning, monitoring and extension of the network and its management features. Network management includes more than fault detection, port configuration, etc., but also the deployment and performance monitoring of client services.

When moving beyond the size of a local enterprise network, NMS backup and restoration for network elements is critical for continual offering of network services. ForeSight supports fail-over servers as hot stand-bys for the NMS and database servers.

The ForeSight 6300's graphical maps, auto-discovery, integration of independent FCAPS modules, scalability, and stable operation create the solution for full life-cycle management of your network.

ORDERING INFORMATION

FS6300/LX: FS6300 Management Station. Supports up to 10,000 managed interfaces. Includes database commercial license, rackmount workstation, RAM, HD, backup device, 17-in. monitor, and pre-installed FS6300 software per preceding "Supported Feature" table.

FS6300/DX: FS6300 Management Station. Supports up to 100,000 managed interfaces. Includes database commercial license, rackmount workstation, RAM, HD, backup device, 17-in. monitor, and pre-installed FS6300 software per preceding "Supported Feature" table.

FS6300/EX: FS6300 Management Station. Supports more than 100,000 managed interfaces. Includes database commercial license, rackmount workstation, RAM, HD, backup device, 17-in. monitor, and pre-installed FS6300 software per preceding "Supported Feature" table.

FS6300/WRAC: FS6300 Windows Remote Application Client includes Windows-based PC with WRAC software to operate remotely with the FS6300/LX, -/DX, or -/EX Management Stations

G.SHDSL Line Card

Model 3096RC 16-Port G.SHDSL TDM Concentrator



G.SHDSL front card

Connect 16 G.SHDSL users and support nx64 kbps access up to 2.3 Mbps.

Patton has combined G.SHDSL ports, DACS, and WAN functions into a powerful system operating on Patton's ForeFront Access Platform. The Model 3096RC TDM-Digital Access Concentrator, or T-DAC, links 16 G.SHDSL circuits to multiple WAN uplink modules and offers completely flexible any-to-any grooming. Each port offers user-selectable nx64 (to 2.3 Mbps) data rates. With its built-in cross-connect, each data channel, or channel group, can be multiplexed onto any uplink or DSL port—even to ports on other 3096RC blades in the same chassis. The entire

system is easily managed through an integrated SNMP/HTTP-based NMS. Use the T-DAC in any Patton 2U, 4U, or 6U ForeFront Access System and scale-up density while reducing costs! Fully redundant power and integrated cooling enable these lightweight chassis to grow while accepting new technologies.

Harness the explosive growth of DSL with a tightly integrated, cost-effective solution to aggregate high speed traffic while gaining flexibility and protecting your investment. Choose the 3096RC for your next network rollout.



Rear transition modules with flexible interface capabilities

FEATURES & BENEFITS

- ✓ 16 G.SHDSL ports per card
- ✓ Standards based DSL is interoperable with third party G.SHDSL modems
- ✓ Speed to 2.3 Mbps on a single twisted pair
- ✓ Distance to 32,000 feet (9,754 meters)
- ✓ Built-in TimeSlot DACS for any-to-any mapping of DSO timeslots
- ✓ Flexible WAN Egress: 4, 8, 12 or 16 T1/E1 Rear Transition module
- ✓ WEB/SNMP manageable from anywhere in the world via the Internet
- ✓ Hot-swappable front and rear cards
- ✓ Complete alarm facilities
- ✓ Uses standard copper twisted pair
- ✓ Integrated line protection circuitry on rear transition module protects your investment
- ✓ User selectable G.SHDSL (TCPAM line coding) or HDSL (2B1Q line coding)

ORDERING INFORMATION

16-port G.SHDSL T-DAC front/rear card sets

3096RC/16G0E: 16 DSL, No E1/T1 ports

3096RC/16G4E: 16 DSL, 4 E1/T1 ports

3096RC/16G8E: 16 DSL, 8 E1/T1 ports

3096RC/16G12E: 16 DSL, 12 E1/T1 ports

3096RC/16G16E: 16 DSL, 16 E1/T1 ports

16-port G.SHDSL T-DAC front card

3096RC: 16 E1/T1 ports; no rear transition module

T-DAC rear cards

3096RCT/0E: 50-pin Telco for 16 G.SHDSL ports (no E1/T1 ports)

3096RCT/4E: 50-pin Telco for 16 G.SHDSL ports; 68-pin SCS1 for 4 E1/T1 WAN ports.

3096RCT/8E: 50-pin Telco for 16 G.SHDSL ports; 68-pin SCS1 for 8 E1/T1 WAN ports.

3096RCT/12E: 50-pin Telco for 16 G.SHDSL ports; 68-pin SCS1 for 12 E1/T1 WAN ports.

3096RCT/16E: 50-pin Telco for 16 G.SHDSL ports; 68-pin SCS1 for 16 E1/T1 WAN ports.

Cables

10-3096TM68/64-6 & 10-3096TM64-6: Cable combination for T1/E1 to punch down block

10-3096TM50-20: Cable for DSL to punch down block

Any-to-any time slot mapping



With the 3096RC in the ForeFront AIS, users have total flexibility in mapping their data. Whether it is concentration, segmentation, metro mapping, WAN mapping, or pass-thru, the 3096RC can handle it. Choose an application or mix them all within the same card. The user has total flexibility.

SPECIFICATIONS

G.SHDSL: G.991.2 ITU G.SHDSL Annex A and Annex B G.994.1 G.hs nx64 kbps data rates up to 2.3 Mbps (n=1...36) over 2 wires, full-duplex, symmetrical TCPAM encoding

G.SHDSL Distance: 32,000 feet (9,754 m) at 1.92 kbps; 18,000 feet (5,487 m) at 2.304 Mbps

G.SHDSL connection: 16 ports presented on a 50-pin Telco connector

Transition modules: Uplink module options include 4, 8, 12, or 16 T1/E1 ports

Ethernet Port: Single 10/100Base-T (RJ-45 connector)

G.SHDSL modems: Patton 3201, 3086, and other standards-based G.SHDSL modems

WAN clocking: Internal, Network (from T1/E1 WAN port) or system via H.110

G.SHDSL clocking: Provides clocking to the remote NTUs/modems

Front panel indicators: LEDs for power, CPU, system, Ethernet, clock source, alarms, test mode, DSL, and WAN

Management services: HTTP, SNMP, TELNET, Ethernet, RS-232 Console Port, SYSLOG Client, Remote Software Upgrade via FTP

Alarm Reporting: Configurable alarms; remote SNMP traps, front panel LEDs; 3-contact relay (3-pin terminal block)

Compliance: Safety UL/CSA per UL1950 (METS) Canadian cMET and CS-03, EMC Directive 89/336/EEC, Low-Voltage Directive 73/23/EEC (EN-60950),

FCC Part 15, CE Mark, CTR12, CTR13 FCC Part 68.

Op. Temp.: 14–140°F (-10–60°C)

Humidity: 5–90%, non-condensing

Dimensions

Front blade
0.75H x 10.5W x 6.3D in.
(1.9H x 26.7W x 16.0D cm)

Rear blade
0.75H x 10.5W x 3.15D in.
(1.9H x 26.7W x 8.0D cm)

Note: DSC and WAN cables sold separately.

IDSL Line Card

Model 3196RC 16-Port IDSL TDM Concentrator



The Patton Model 3196RC IDSL T-DAC connects 16 users and supports data rates of 64, 128, and 144 kbps. This high density offering provides affordable access concentration to speed up first-mile networks.

Patton's Model 3196RC IDSL TDM-Digital Access Concentrator, or IDSL T-DAC provides affordable first-mile access concentration for virtually any low speed network application.

Leverage low cost IDSL technology to offer the right service at the right price. Patton has combined IDSL ports, DACS, and WAN up-links and functions into a powerful system operating on Patton's ForeFront Access Platform.

The Model 3196RC, links up to 16 IDSL circuits to multiple WAN modules and offers complete any-to-any DSO grooming. Each IDSL port offers user selectable data rates of 64, 128, and 144 kbps. With

a built-in cross connect, each data channel or channel group can be multiplexed onto any up-link or other DSL port — even ports on other 3196RC or 3096RC T-DACS in the same chassis. An integrated SNMP/HTTP-based management system allows for easy configuration via any SNMP enabled NMS.

Each 3196RC T-DAC has its own processing capability built in, offering continuous operation even in the presence of multiple network outages. Use the T-DAC in any Patton 2U, 4U or 6U ForeFront Access System and affordably scale up density to network growth requirements.



Rear transition modules with flexible interface capabilities

FEATURES & BENEFITS

- ✓ Up to 16 IDSL ports per card — Get high density per card and lower your cost per port. Easily scale by adding more cards
- ✓ Speeds of 64, 128, & 144 kbps — Each port is independently selectable for any bandwidth. Distances to 16.4 km/10.1 miles on 0.9 mm/19 gauge copper wire
- ✓ Standards-based line coding — Uses 2B1Q per ETSI ETR-080 and ANSI T1.601 standards
- ✓ Built-in timeslot DACS — Perform any-to-any DSO mapping between any DSL and WAN port in a ForeFront chassis
- ✓ SNMP/HTTP management — SNMP/HTTP manageable from anywhere in the world including attached CPE units
- ✓ Complete alarm facilities — Configurable alarm reporting with SNMP traps, front panel LEDs, 3-contact relay, and syslog messages



I'm Ovidio, Patton's Regional Director of Latin America Operations. If you have any questions about products or applications using DSL technology, please call me at +1 301.975.1000, x118, or send e-mail to ovidio@patton.com.

Application diagram

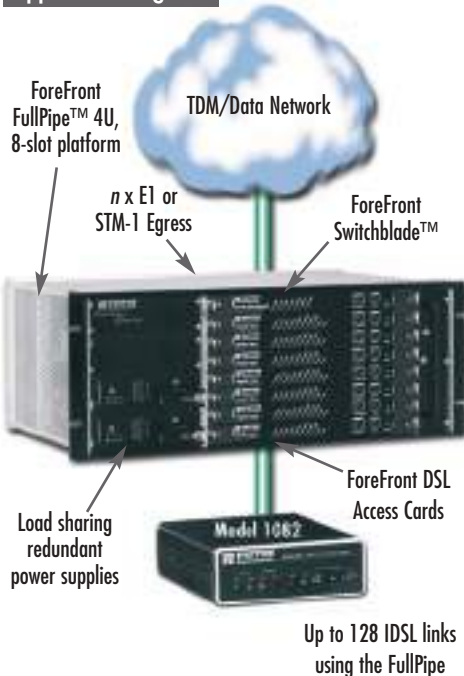

SPECIFICATIONS

IDSL: 2B1Q modulation per European Telecommunications Standards Institute (ETSI) as ETR-080 and American National Standards Institute (ANSI) as T1.601
IDSL Distance: 16.4 km/10.1 miles using 19-gauge (AWG)/0.9-mm copper wire
IDSL Connections: Up to 16 ports presented on a 50-pin RJ-21x Telco connector
Rear Module: Up-link options include 4, 8, 12, or 16 T1/E1 ports
Ethernet Management: Single 10/100Base-T (RJ-45 connector); simultaneous dual redundant operation over backplane
IDSL Modems: Use Patton Model 1082 and 1092A IDSL modems
WAN Clocking: Internal, Network (from T1/E1) or via the system backplane from any other card
IDSL Clocking: Provides clocking to the remote NTUs/Modems
Front Panel Indicators: LEDs for power, CPU, system, Ethernet, clock

source, alarms, test mode, DSL, and transition module WAN ports
Management Services: HTTP, SNMP, Telnet, Ethernet, RS-232 Console Port, syslog client, remote software upgrades via TFTP
Alarm Reporting: Configurable alarms, remote SNMP traps, front panel LEDs, 3-Contact Relay (Form-C)
Compliance: Safety: UL 60950, IEC 60950 (CB Scheme); EMI: FCC Part 15 Class 'A'; Telecom: TIA/EIA/IS-968 (for T1/E1 interfaces); CE
Operating temp.: 14 to 140°F (-10 to 60°C);
Humidity: 5 to 90%, non-condensing
Dimensions:
Front Module: 0.75 H x 10.5 W x 6.3 D in. (1.9 H x 26.7 W x 16.0 D cm)
Rear Module: 0.75 H x 10.5 W x 3.15 D in. (1.9 H x 26.7 W x 8.0 D cm)

Note: DSC and WAN cables sold separately.

ORDERING INFORMATION

- 3196RC:** T-DACS, Front Card, 16 IDSL
- 3196RC/16IOE:** T-DACS, 16 IDSL & 0 T1/E1
- 3196RC/16I16E:** T-DACS, 16 IDSL, 16 T1/E1
- 3196RC/16I4E:** T-DACS, 16 IDSL & 4 T1/E1
- 3196RC/16I8E:** T-DACS, 16 IDSL & 8 T1/E1
- 16-port G.SHDSL T-DAC front card**
3196RC: 16 E1/T1 ports; no rear transition module
- T-DAC rear cards**
3196RC/0E: 50-pin Telco for 16 G.SHDSL ports (no E1/T1 ports)
3196RC/4E: 50-pin Telco for 16 G.SHDSL ports; 68-pin SCSI for 4 E1/T1 WAN ports.
3196RC/8E: 50-pin Telco for 16 G.SHDSL ports; 68-pin SCSI for 8 E1/T1 WAN ports.
3196RC/12E: 50-pin Telco for 16 G.SHDSL ports; 68-pin SCSI for 12 E1/T1 WAN ports.
3196RC/16E: 50-pin Telco for 16 G.SHDSL ports; 68-pin SCSI for 16 E1/T1 WAN ports.

ADSL2+ Triple-Play Access

Model 3101RC ADSL2/2+ IPDSLAM Module

The Patton Model 3101RC provides up to 48 ADSL2/2+ ports of triple-play access, supporting extended reach and higher downstream bandwidth up to 24 Mbps.



The Model 3101RC delivers affordable ADSL/ADSL2/2+ network access for triple-play ready ADSL service. The ADSL2+ IPDSLAM module, together with Patton's ForeFront Access Platform, is the premier solution for fault tolerant triple-play enabled network deployments. The Model 3101RC offers complete ADSL, ADSL2 and ADSL2+ support including extended range operation, and enhance speeds. Each 3101RC IPDSLAM Module includes all the intelligence necessary to function as a complete single card IPDSLAM thereby providing unparalleled redundancy and fault tolerance in network deployments. The Model 3101RC includes redundant

10/100/1000 Ethernet uplink ports as well as redundant mid-plane connections to ensure non-stop operation.

The Model 3101RC is designed for triple-play networks where the reliable delivery of IP based voice, video and data services depends on the QoS metrics that are assigned to the flows. Consequently, the Model 3101RC supports the mapping of ATM CBR/UBR/VBR traffic types and cell rates to IEEE 802.1p/Q VLAN priority classes. VLAN stacking or "Q-in-Q" is likewise supported to ensure transparent extension of subscriber VLAN networks. In order to maximize WAN bandwidth, IGMP Snooping is supported to ensure that IP Multicast traffic is detected and forwarded accordingly.



24-port, 1-slot version available!

FEATURES & BENEFITS

- ✓ Built-in Triple-Play Support—ADSL2+ high-bandwidth downstream with Multicast support and QoS included.
- ✓ QoS—Per PVC traffic classification with shaping and policing; 802.1p VLAN priority; ToS/DiffServ stripping and priority queuing
- ✓ 24–48 ADSL2/2+ Ports—"Right size" the deployment with the best port-per-card ratio. Easily scale by adding cards.
- ✓ Per-Port Configuration—To facilitate the provisioning and tailoring of services, ports are independently selectable to the individual DSL standard and required port speeds.
- ✓ SNMP/HTTP Management—SNMP/HTTP manageable from anywhere in the world including attached CPE units.
- ✓ Management Features—Configurable alarm reporting with SNMP Traps, RMON for performance monitoring, Dying Gasp support on ADSL ports, I.610 OA&M, F5 loopback support, G.PLOAM, embedded HTTPS web server for easy configuration via a browser.
- ✓ Annex M and Annex L support.

ORDERING INFORMATION

3101RC/24A/2GE: ADSL IPDSLAM with 24 ADSL Annex A Ports and two Gigabit Ethernet ports occupying one ForeFront slot

3101RC/48A/2GE: ADSL IPDSLAM with 48 ADSL Annex A Ports and two Gigabit Ethernet ports occupying two ForeFront slots

3101RC/24B/2GE: ADSL IPDSLAM with 24 ADSL Annex B Ports and two Gigabit Ethernet ports occupying one ForeFront slot

3101RC/48B/2GE: ADSL IPDSLAM with 48 ADSL Annex B Ports and two Gigabit Ethernet ports occupying two ForeFront slots

SPECIFICATIONS

ADSL Ports: 24 or 48 ports configurable as ANSI T1.413i2, G.992.1 (G.DMT) Annex A/B with UR-2, G.992.2 (G.Lite), G.992.3 (ADSL2) Annex A/B/L/M, G.992.5 (ADSL2+) Annex A/B/L/M supporting G.997.1 (G.PLOAM) and G.994.1 (G.HandShake)

Ethernet Ports: Two 10/100/1000 backplane-facing, auto-negotiating ports; Two 10/100/1000 auto-negotiating rear card ports with SFP interface for easy media selection; Single 10/100 auto-negotiating, full/half duplex front card; 802.1ad Link Aggregation and LACP

ATM Support: 12 PVCs per port including per PVC traffic classification; RFC 1483/2684; PPPoE forwarding; AAL5 per I.363.5; Traffic classes: UBR, CBR, VBR-rt, VBR-nrt; UNI 3.1/4.0; I.610 OA&M with F5 loopback

VLAN & bridging support: IEEE 802.1Q including per interface tagging;

IEEE 802.1p priority queuing and re-stripping; VLAN stacking or "Q-in-Q"; Spanning Tree (802.1D); RSTP (802.1w); MSTP (802.1s/Q); IGMP Snooping; MAC address filtering (8 per VLAN)

Management Service: HTTP/HTTPS, SNMP, Telnet Ethernet, RS-232 Console Port, SYSLOG Client, Software upgrade via TFTP

Alarm Reporting: Configurable alarms; Remote SNMP traps; front panel LEDs

Compliance: UL-1950; CSA per 22.2-No. 950; FCC Part 15 Class A; CE Mark; EN55022; EN61000; RoHS Compliant

Operating temp.: 0–60°C (14–104°F)

Humidity: 5–90% non-condensing

Why use our 3101RC?

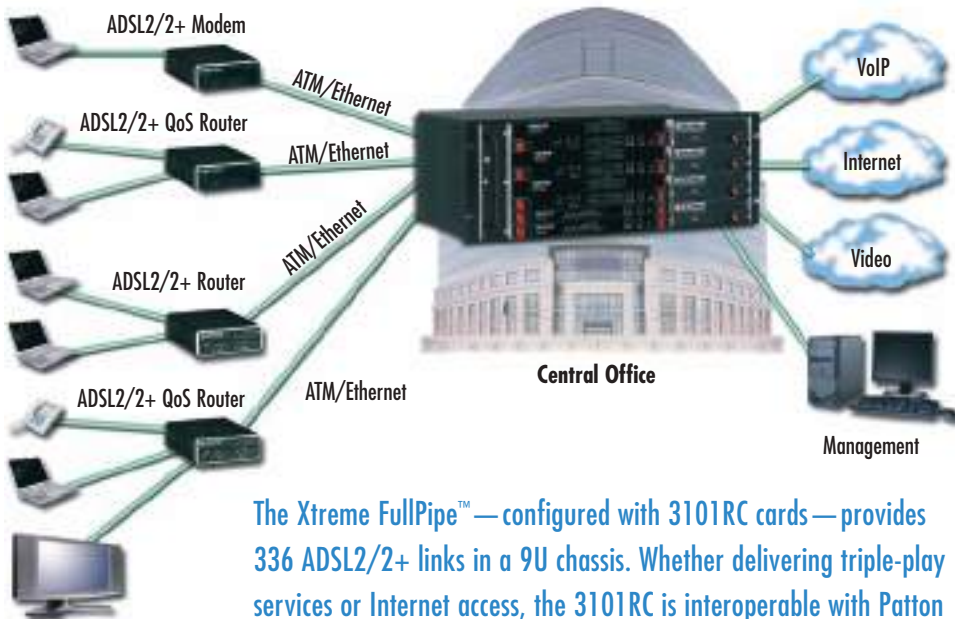

The Xtreme FullPipe™—configured with 3101RC cards—provides 336 ADSL2/2+ links in a 9U chassis. Whether delivering triple-play services or Internet access, the 3101RC is interoperable with Patton CPE as well as with third-party solutions.

Router Line Card

Model 6081RC EdgeROUTE

This feature-rich IP service module for ForeFront AIS addresses the demanding deployment needs of service and enterprise organizations.



The Patton Model 6081RC is a Packet Access Server for ForeFront AIS that is optimized to process IP traffic from multiple access and uplink cards. The Packet Access Server converts any ForeFront AIS chassis into a powerful IpDSLAM or modular Access Router. The 6081RC comes standard with dual 10/100Base-T Ethernet ports, while at the same time, it has access to any port on any card attached to the ForeFront System for up-linking traffic. With its powerful feature set, service providers can deploy new IP services while retaining the ability to support their TDM infrastructure investment.

The 6081RC supports MAC Address filtering, VLAN priority, and VLAN tagging to facilitate the transition

from traditional IP router-based networking to modern-day VLAN/MPLS networks. Regardless of whether the customer traffic comes in via DSL or T1/E1, the EdgeROUTE can terminate and tag the stream, making it transparent to core/edge networks.

Easily tailor and manage the level of service to the needs of the subscriber with traffic shaping and policing. Filter by IP address, IP port or by physical port in either ingress or egress directions. The extensive filtering capabilities of the 6081RC turns this access router into a capable edge firewall. NAT is likewise supported for either masquerading applications or for simple address translation. Customize security for each end user or use a standard configuration for all. Use the built-in traffic filtering features of the 6081RC and SSH to secure your management connection.

VPN applications, including access service wholesaling, can be deployed with L2TP providing standards-based tunneling of IP traffic and easy interconnection with existing VPN networks. Use RIP or OSPF to route traffic between any WAN, LAN or DSL port.



FEATURES & BENEFITS

- ✓ Dual 10/100 Ethernet easily bridges the gap between the LAN and Access Network with differentiated service offerings
- ✓ Built-in IP address, IP port, and MAC address filtering
- ✓ Perform IP address and port translation for any ForeFront port
- ✓ Extensive IP Routing with RIP and OSPF allows easy interoperability and integration.
- ✓ Create layer 2 and layer 3 VPNs with PPTP and IPsec
- ✓ SNMP/HTTP manageable from anywhere in the world including attached CPE units.

SPECIFICATIONS

Routing: RIPv1 (RFC 1058), RIPv2 (RFC 2453), OSPFv2 (RFC 2328), VLSM (RFC 1878)

RADIUS client: Authentication (RFC 2865 & 2868), Accounting (RFC 2866 & 2867), PAP (RFC 1332), CHAP (RFC 1334 & 1994)

VPN Services: L2TP (RFC 2661 with RFC 2809 & 2888) - LAC & LNS, PPTP, IPsec

IP Services: (RFC1701/2784), IP-within-IP (RFC 2003), ARP (RFC0826), Proxy-ARP (RFC1027), ICMP (RFC0950, RFC1256), NTPv3 (RFC1305), IGMP & IGMPv2 (RFC2236), DiffServ (RFC2474), NAT (RFC 1631/2663/2766/2993); DHCP (RFC2131/2132/2563)

Ethernet Ports: Dual 10/100BaseT (RJ-45 connector); auto-negotiating; half or full duplex operation

Management Service: HTTP, SNMP, Telnet, Ethernet, RS-232 Console Port, SYSLOG Client, Software upgrade via FTP, SSH, SNTIP

Alarm Reporting: Configurable alarms; Remote SNMP Traps; Front Panel LEDs

Compliance: Safety: UL/CSA per UL1950 (METS) Canadian cMET and CS-03, EMC Directive 89/336/EEC, Low-Voltage Directive 73/23/EEC (EN60950), FCC Part 15, CE Mark, CTR12, CTR13, FCC Part 68

Op. temp.: 0–40°C (32–104 °F)

Humidity: 5–90% non-condensing
Dimensions:
Front blade: 0.75 H x 10.5 W x 6.3 D in. (1.9 H x 26.7 W x 16.0 D cm)
Rear blade: 0.75 H x 10.5 W x 3.15 D in. (1.9 H x 26.7 W x 8.0 D cm)

Typical application

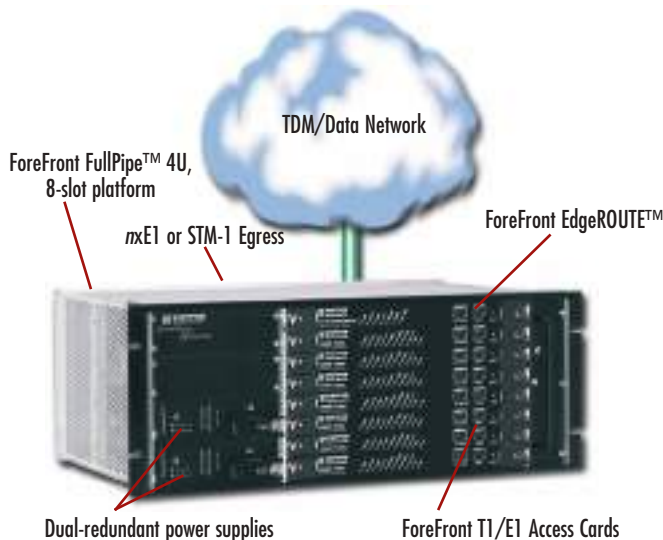

ORDERING INFORMATION

6081RC/800H/FE2P: IP Router, 800-MHz with 3 10/100 Front Access Ethernet Ports

6081RC/800H/FE2T: IP Router 800-MHz with 1 front 10/100 Ethernet ports & 2 rear 10/100 Ethernet ports

6081RC/800H/GE2P: IP Router, 800-MHz with 1 10/100 & 2 Gigabit Ethernet Ports

6081RC/800H/GE4P: IP Router, 800-MHz with 1 10/100 & 4 Gigabit Ethernet Ports

Matrix Switch Line Card

Model 6511 Matrix-SW/155

Get non-blocking any-to-any TDM access, packet-switched Ethernet, and high speed trunking—all in a single card.

The Model 6511's flexible channel switching fabric allows non-blocking switching from any input to any output. The channelized STM-1 interface integrates into a SDH/SONET network, enabling users to channelize an STM-1 down to 64 kbps timeslots. With full grooming capability, the Model 6511 DACs allows any-to-any TDM mapping and can place any channel from any card onto any port.

Combined with the ForeFront AIS 40-Gig Packet-Switched Backplane, the Model 6511 Matrix Switch redundantly interconnects every slot—at wire-speed—and aggregates traffic from each system card onto dual-switched uplink Ethernet ports. With increased performance and throughput, the packet backplane allows non-blocking access to the Matrix Switch, other system cards, and the uplink ports.

With the ForeFront architecture, TDM and packet can be used simultaneously and to full capacity. In a system loaded with dual Matrix Switches, the high speed channel switching and

packet backplane on the Model 6511 offers 1+1 redundancy.

Management is a snap with VT-100, TELNET, SNMP and WEB options. Connect to any card out-of-band or route management traffic through available timeslots in-band. Complete switching database allows easy building of circuits end-to-end.

Master time and space with the Model 6511 Matrix Switch and realize an unequalled level of density and control over the new convergent network.



FEATURES & BENEFITS

- ✓ Non-blocking I/O fabric
- ✓ Get dedicated connectivity to every input and every output port while grooming TDM or switching packet data
- ✓ Use dual 6511s and get 1+1 redundancy.
- ✓ Hot swappable cards for fast maintenance and quick upgrades.
- ✓ Integrated STM-1 DACS
- ✓ Resolve traffic down to 64 kbps timeslots, with any-to-any mapping.
- ✓ WEB/SNMP manageable—Use the embedded HTTP/SNMP agent to manage the Model 6511 from anywhere in the world.
- ✓ Optical or electrical egress: electrical BNC or optical SC connectors
- ✓ Redundant packet switching

SPECIFICATIONS

Line Framing: DS1-SF, SLC-95, ESF, E1—G.704 basic, CRC-4 multiframe (G.706 framing), DS3—M23, C-bit parity formats, E3—G.751, G.832 E3, STM-1—G.707, SONET/STS-3—Per ANSI T1.105-2001

Mapping: DS1—VT1.5 → STS-1 SPE, TU-11 → STM1/VC3, TU-11 → TUG3 → STM1/VC4, TU12 → STM1/VC3, TU-12 → TUG3 → STM1/VC4; E1—VT2 → STS1 SPE, TU-12 → STM-1/VC3, TU-12 → TUG3 → STM-1/VC4; DS3—DS3 → VC3 → AU3 → STS-1 SPE; STM-1—G.707; SONET/STS3—Per ANSI T1.105.02-2001

Clocking: STM-1—G.813; STS-3—ANSI T1.101-1999, T1.105.09-1995, G4-1244

Error Counts: G.821 & G.826 (ES, SSES, US, EB, and BBE; T1.231 & GR-253-CORE ES, SES, US and SEFS

Line Testing: PRBS per ITU-T 0.151 & 0.152; DS3/E3 Diagnostic & Line Loopback; DS2 Demux Loopback; T1/E1 Diagnostic & Loopback

Ethernet Ports: Dual 10/100Base-T (RJ-45 connector)

STM-1/STS-3 Ports: Single mode dual SC fiber (20km) per G.957 using 1300 nm lasers per G.652 or Dual 75-Ohm BNC per G.703

LED Indicators: LEDs for power, CPU, Dual Ethernet, test mode, egress synchronization, egress trunk status

Management Services: HTTP, SNMP, TELNET Ethernet, RS-232 Console Port, SYSLOG Client, Remote Software Upgrade via FTP

Alarm Reporting: Configurable alarms; Remote SNMP Traps; Front Panel LEDs

Compliance: Safety: UL/CSA per UL1950 (METS) Canadian cMET and CS-03, EMC Directive 89/336/EEC, FCC Part 15, CE Mark, CTR12, CTR13 FCC Part 68, Laser Safety: Class 1, IEC-825-1, 1993

Op. temp.: 14 to 43°F (-10 to 60°C);

Humidity: 5–90%, non-condensing

Any-to-any time slot mapping

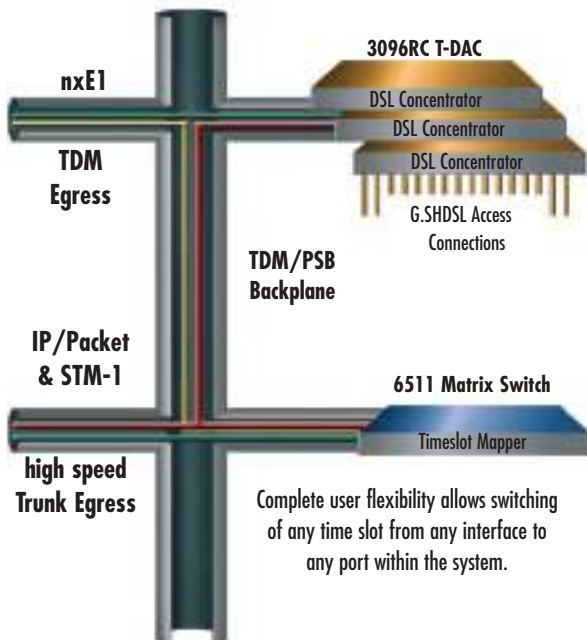

Complete user flexibility allows switching of any time slot from any interface to any port within the system.

The Matrix Switch architecture guarantees total non-blocking operation for any TDM application and for Packet switching applications over the redundant Packet Switching Bus (PSB). With the ability to simultaneously transmit and receive on both full-duplex 10/100 Ethernet up-link ports, the Matrix Switch offers unparalleled switching to any DSL, E1, STM-1 media as well as redundant PSB and TDM buses.

Rear card options include electrical (BNC) and optical (SC) physical connections.



ORDERING INFORMATION

6511RC/SST/SC20: OC-3/STM-1 TDM and Packet Switch, with SC optical interface

6511RC/SST/EBNC: OC-3/STM-1 TDM and Packet Switch, with BNC electrical interface

PATTON

Network Access & Connectivity Solutions for Enterprise, Carrier & Industrial Applications

Patton Electronics—a leader in the production of network access and connectivity products—is building on its expertise in integrated network access, transmission, IP and Frame Relay technologies and leading in the development of right-priced products to simplify human and machine access to the global network.

The Patton brothers, Bobby and Burt, founded Patton Electronics in 1984, while students in college. Over the succeeding 20+ years, Patton has taken those simple beginnings and expanded into a multi-national manufacturing company that today employs more than 180 people and provides a product line in excess of 1000 items.

For your next project that needs to meet aggressive price points, while delivering high performance results, call on Patton. We're ready to deliver!

www.patton.com

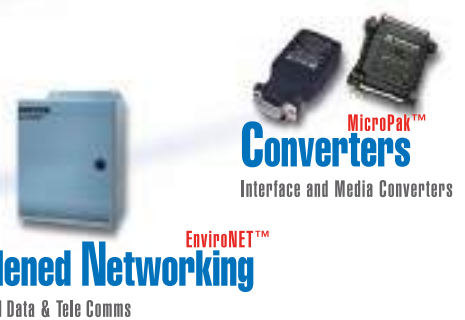

High-Speed G.SHDSL Concentrator for IP Traffic

Model 3224 ipDSLAM

The Model 3224 enables a wide variety of high speed dedicated access services by creating concentration points for routed IP traffic.



Patton's Model 3224 IPDSLAM is a cost-effective solution for dedicated Internet service delivery in situations where the business case does not support the separate deployment of high-density, chassis based solutions, service creation platforms, and routers. With support for 24 ports of up to 4.6 Mbps symmetric G.SHDSL links and numerous uplink options, the 3224's flexibility is unsurpassed.

The 3224 IPDSLAM routes IP traffic using numerous standard routing protocols while maintaining strict quality of service (QoS) by prioritizing operator configured traffic flows using standard ToS bits. VPN applications can easily be deployed with L2TP or PPTP-based tunneling of IP traffic. Assigning traffic priorities to VPNs guarantees QoS.

Extensive IP address and port filtering makes the 3224 an excellent multi-user firewall and service creation platform. Either customize firewall services to the needs of the individ-

ual users or provide a standard global firewall service. Use the filters to segregate the traffic and wholesale service to other providers without losing control of your network or the level of service that is offered.

Well thought-out solutions to common networking issues include support for NAT & NAPT for avoiding IPv4 address depletion, DHCP for value added services to SOHOs, DNS caching for quick address look-ups, SNTP for time server synchronization of edge devices, and RADIUS accounting and authentication for validation, verification and accounting of user sessions.

Optional up-link ports provide the flexibility of selecting the up-stream interface that is right for your network deployment needs. Co-locate with a DLC or use it in a building's wiring closet. Redundant, load sharing, removable power supplies provide maximum power protection. External BITS

FEATURES & BENEFITS

- ✓ NAT & NAPT—Avoid address depletion
- ✓ DiffServ/ToS—QoS for all traffic flows
- ✓ IP address & port filtering—Create your own firewall
- ✓ DNS caching—Faster address lookups
- ✓ DHCP—Manage IP addressing for user LANs
- ✓ PPTP & PPPoE—Create Layer 2 tunnels
- ✓ IPsec—Create Layer 3 VPNs
- ✓ SNTP—Synchronize edge devices to time source
- ✓ RIP, OSPF & BGP—Routing flexibility
- ✓ RADIUS Accounting & Authentication—Authenticate & track users with standard tools
- ✓ Expansion modules—Adapt IPDSLAM to your network needs
- ✓ 24 G.SHDSL Ports—Symmetric service to 4.6 Mbps
- ✓ Redundant, removable power supplies—Non-stop operation

and alarm ports facilitate the deployment of the 3224 IPDSLAM in traditional central office environments.

Whether you are an ISP, ASP, or Carrier, the IPDSLAM will improve the quality and variety of your service offering while reducing your investment in value added service platforms.

Layer 2 and layer 3 VPNs

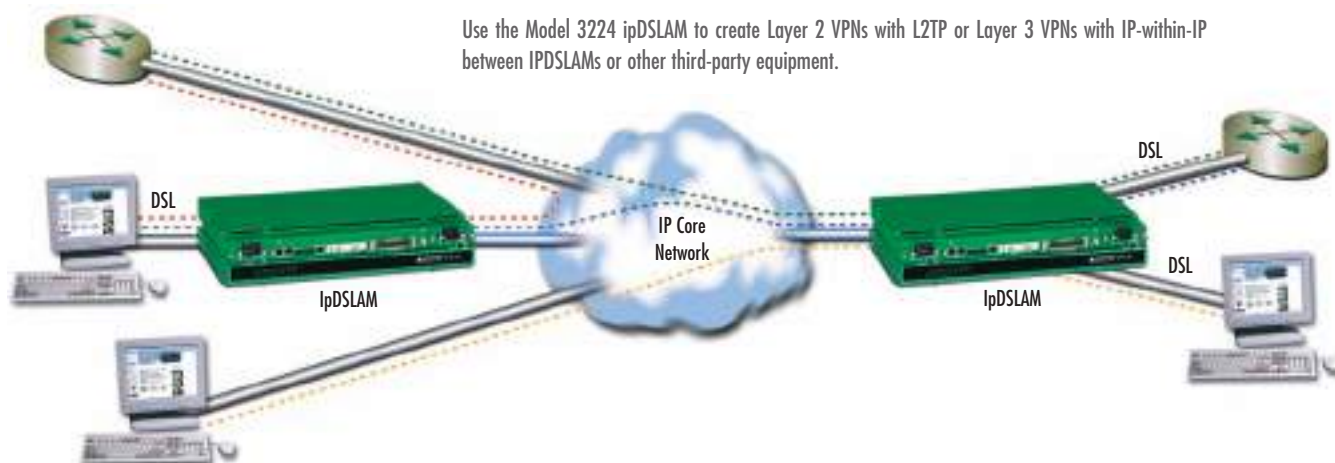

Use the Model 3224 ipDSLAM to create Layer 2 VPNs with L2TP or Layer 3 VPNs with IP-within-IP between IPDSLAMs or other third-party equipment.

Deployment options

G.SHDSL for IP networks can be deployed in a variety of different ways: 1. In a multi-dwelling unit (MDU) or multi-tenant unit (MTU) utilizing in-building voice-grade wires; 2. In a remote POP connected to residential or community users; 3. In a co-location facility for last-mile access.

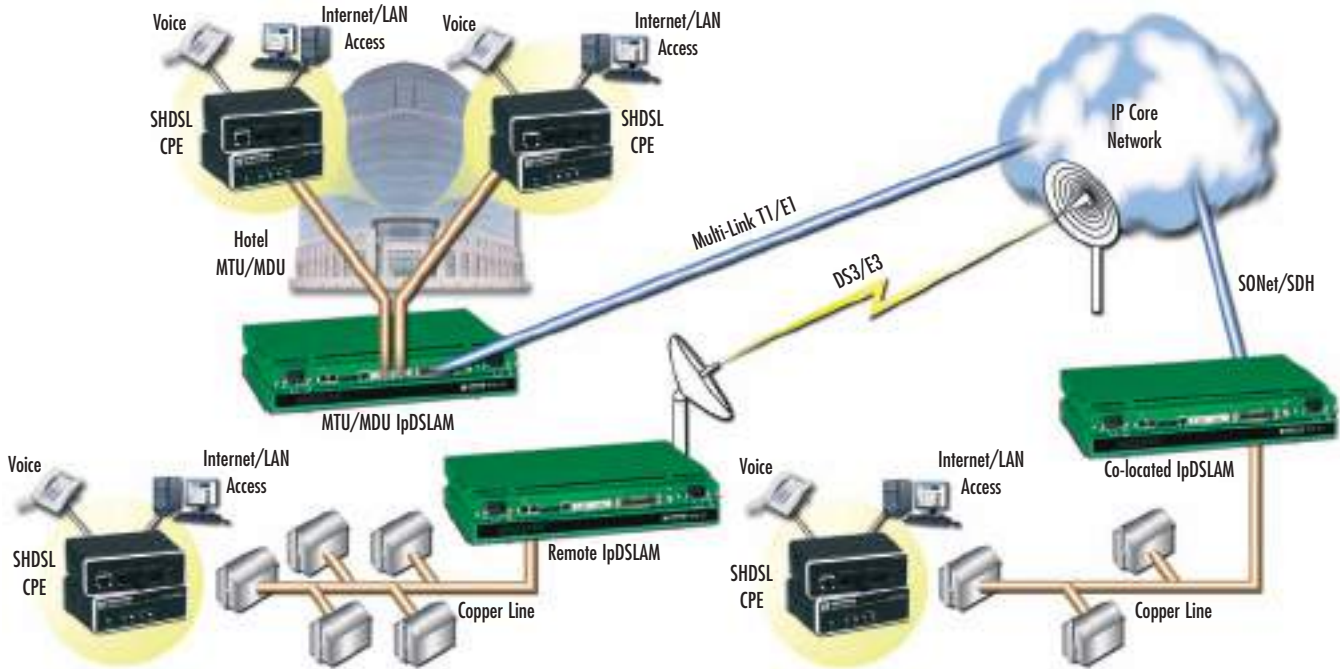

G.SHDSL DiamondLink™ Router

For your most valuable end-point connections, use Patton's DiamondLink Router. Supporting auto-sensing 10/100 Ethernet with MDI-X switching and web-based management, it's a real gem!



See page 89



I'm Tshaka, one of Patton's Support Engineers. If you're having a problem with a Patton product, I'll find the solution quickly. To buy one of these state-of-the-art ipDSLAMs, call +1 301.975.1000 or send e-mail to sales@patton.com.

SPECIFICATIONS

G.SHDSL ports: 24 ports presented on an RJ-21X 50-pin connector, each supporting data rates of Nx64 (up to 4.6 Mbps)

Egress Modules: Up-link modules include: 4 or 8 T1/E1 ports; Single unchannelized DS3/E3; DS3/E3 ATM; Single OC-3/STM-1; Single OC-3/STM-1 ATM (Refer to individual modules for specifications)

Ethernet Ports: Dual 10/100Base-T (RJ-45 connector)

WAN clocking: Internal, network receive recover (from WAN port), external BITS via 3-pin terminal block

Front Panel Indicators: LEDs for power, CPU, system, Ethernet, External clock, test mode, DSL, and Up-link Egress module

Power Supplies: Hot swap, dual-redundant universal AC/DC; AC power: 90-264 VAC (50/60 Hz); DC power: -36 to -72 VDC

Management Service: HTTP, SNMP, Telnet, Ethernet, RS-232 Console Port, SYSLOG Client, Software upgrade via FTP

Alarm Reporting: Configurable alarms; Remote SNMP Traps; Front Panel LEDs; 3-Contact Relay (3-pin terminal block)

Compliance: Safety—UL/CSA per UL1950 (METS) Canadian cMET and CS-03. EMC Directive 89/336/EEC, Low-Voltage Directive 73/23/EEC (EN60950),

FCC Part 15, CE Mark, CTR12, CTR13, FCC Part 68

Op. Temp.: 32–104°F (0–40°C)

Humidity: 5–90% non-condensing

Dimensions: 19.00W x 12.60D x 1.75H in. (48.25W x 32.00D x 4.44H cm) 1U high by 19 in. wide

ORDERING INFORMATION

3224/G/RUI: 24 SHDSL ports; 2 10/100 Ethernet ports; No up-link; redundant AC power; Forest Green

3224/G/R48: 24 SHDSL ports; 2 10/100 Ethernet ports; No up-link; redundant DC power; Forest Green

VDSL Access Concentrator/Switch

Model 3324

The Model 3324 provides connectivity for up to 24 users of voice and data services over existing voice-grade twisted-pair wiring.



Patton's Model 3324 VDSL Access Concentrator provides a simple and efficient method of delivering voice and high speed data services over existing copper infrastructure. The Model 3324 employs VDSL (very high bit-rate DSL), the fastest digital subscriber line technology. This technology enables carriers and service providers to provide broadband services that previously could not be provided using other forms of DSL. Using a Model 3324 VDSL Access Concentrator with Model 1058 CPEs will provide services for up to 24 users.

The Model 3324 is a fully manageable Layer 2/3 switch with 24 independently configurable VDSL ports. This feature allows service providers to differentiate their high speed data services. The Model 3324 comes standard with two auto

sensing RJ-45 100/1000BaseT Ethernet ports or an optional industry standard GBIC (Gig Fiber) uplinks.

The Model 3324DV's unique 1U chassis design includes on-board POTS/ISDN splitters for all 24 VDSL channels. This feature enables the simultaneous use of voice and data over a single 2-wire twisted pair without the additional cost and space of an external splitter panel.

For larger applications, up to four Model 3324s can be cascaded to provide a scalable VDSL solution (96 ports). The Model 3324 24-Port VDSL Access Concentrator is Patton Electronic's flagship product and is compatible with the Patton 1058 VDSL CP units.

FEATURES & BENEFITS

- ✓ 24 software selectable asymmetrical or symmetrical
- ✓ Extends Ethernet connections beyond the 328 ft limitations over a single pair of voice-grade wire
- ✓ Fully manageable Layer 2 Ethernet switch/Layer 3 switch and routing functionality
- ✓ Compact 1U design
- ✓ Built-in POTS/ISDN splitter for all 24 VDSL ports
- ✓ Local and remote testing and management capabilities
- ✓ Bandwidth management
- ✓ Dual auto-sensing RJ-45 100/1000 BaseT or GBIC for Ethernet uplink or cascading options
- ✓ Cascade up to 4 VDSL concentrators for up to 96 ports
- ✓ Compliant with ETSI, ITU, and ANSI standards



I'm Steve, one of Patton's Engineers designing ipDSLAMs. To buy one of these state-of-the-art devices, call +1 301.975.1000 or send e-mail to sales@patton.com.

PROTOCOL SPECIFICATIONS

Layer 3 Protocols

RFC 791 IP
RFC 793 TCP
RFC 768 UDP
RFC 950 ICMP
RFC 2236 IGMPv1
IP Multicasting

Ethernet Standards

IEEE 802.1d Spanning Tree
IEEE 802.1p Priority Queuing
IEEE 802.1Q VLAN Tagging

IEEE 802.3ad Port Trunking
IEEE 802.3x Flow Control
IEEE 802.3 Ethernet
IEEE 802.3u Fast Ethernet
IEEE 802.3z Gigabit Ethernet

Management Standards

RFC 2068 HTTP
RFC 1157 SNMP/V1
RFC 1213 MIB II
RFC 1493 Bridge MIB
RFC 1757 RMON

GENERAL SPECIFICATIONS

VDSL Line Interface: 24 ports presented on one RJ-21

POTS-ISDN Interface: 24 ports presented on one RJ-21

Modulation: QAM (Quadrature Amplitude Modulation)

Frequency Range: VDSL: 1–8 Mhz

POTS/ISDN: 0–120 kHz

Transmission: Software selectable symmetrical and asymmetrical line rates

Power Supply: AC: UI (85–265);

Dimensions: 1.73H x 11.22W x 16.22L in. (4.1H x 28.5W x 41.2L cm)

Weight: 13 lbs (0.18 kg)

Operating Temp: 41–122°F (5–50°C)

Storage Temp: –4–149°F (–20–65°C)

Humidity: 10–90% non-condensing

CPE Compatibility

The Model 3324 interoperates with Patton's 1058/CP and 1058RC/CP (see page 91).



1058/CP



1058RC/CP

Voice and data services over VDSL

Using Patton's VDSL Access Concentrator at a central location, up to 24 full-service links can be routed to various room locations. The CO or ISP would provide the fiber uplink from the network to the Model 3324 location. The POTS lines delivered from the PSTN would be concentrated and delivered to the Model 3324 on an RJ-21 connector. The 3324 combines the POTS and Ethernet signals and sends them over the VDSL links to the individual rooms over existing twisted pair, voice-grade wiring. A 1058CP standalone unit is placed in each room to split the signals back into Ethernet (data) and POTS/ISDN (voice) forms for delivery to the end-user. The Model 3324 allows VDSL services on each channel to be configured at various symmetric and asymmetrical line rates to differentiate services or to increase the distance capabilities.

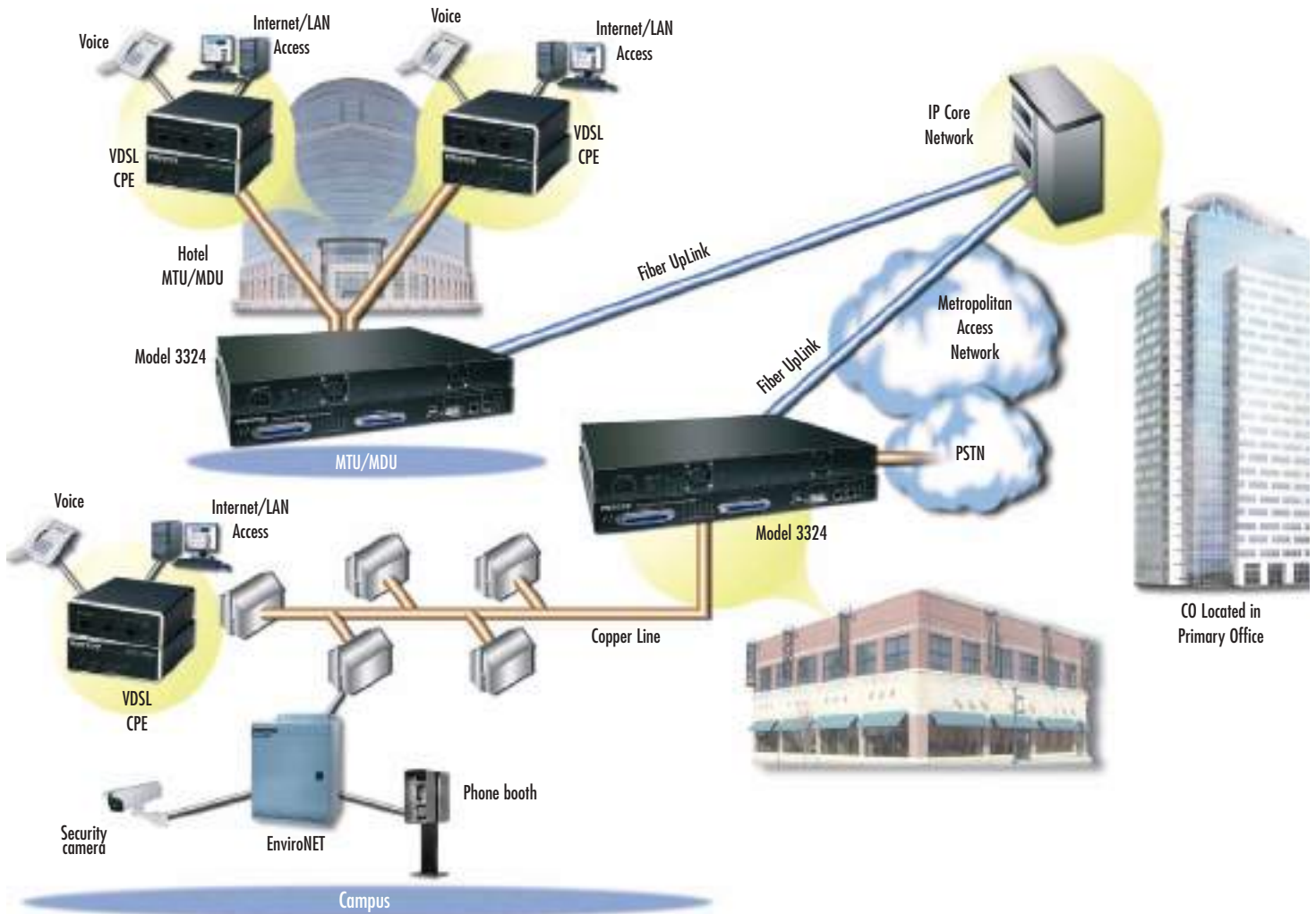

ORDERING INFORMATION

3324DV/GE/UI: 24-Port VDSL Data & Voice Access Concentrator — RJ-45 Autosensing 100/1000 BaseT Uplink (85–265) VAC



I'm Maria, one of Patton's Sales Coordinators. If you have questions about our products, call +1 301.975.1000 or send e-mail to sales@patton.com.



visit us online
www.patton.com

FAST Delivery From Your AUTHORIZED DISTRIBUTOR!



Low-Cost, High-Speed G.SHDSL Modem

Model 3088 RocketLink™ G.SHDSL NTU

Use Patton's RocketLink G.SHDSL Modem for fast, dedicated, always-on access.



The Model 3088 RocketLink Modem drives profitability back into leased-line data services with standards-based G.SHDSL technology. The Model 3088 provides low cost, full-duplex network termination or extension at nx64 rates to 4.6 Mbps. The Model 3088 connects routers, switches, and other access devices, and is available in G.703/G.704, co-

directional G.703, T1/FT1, X.21, and V.35 interfaces. Plus, it is available in a rack card for the Model 1001 universal access rack.

The Model 3088 excels in manageability with built-in loop-back and pattern generators that allow quick verification of DSL lines. Additionally, with software upgradeability via the console port, the unit is ready for the next feature upgrade. Lastly, with remote console support, a centrally located unit can be used to take control of a remote unit via the console port, using an out-of-band management channel.

For true flexibility, the Model 3088 is also compatible with any of Patton's G.SHDSL modems, including the Model 3201 router and ForeFront DSL solutions.

FEATURES & BENEFITS

- ✓ Speeds to 4.6 Mbps over just a single twisted pair of wires
- ✓ Distances up to 32,800 feet (10 km)
- ✓ Software upgradeable
- ✓ G.SHDSL ITU/ETSI interoperability with third-party TDM DSLAMs
- ✓ G.703/G.704, X.21, V.35, and co-directional interfaces available
- ✓ Built-in testing and diagnostics for quick network turn-up and troubleshooting
- ✓ ForeFront plug-and-play operation

CPE for ForeFront



Using ForeFront with the Model 3088 allows deployment of hundreds of DSL circuits from a single low profile chassis. The Model 3088 can be used on the customer premise to deliver T1/E1 co-directional G.703, X.21, or V.35 interfaces.

T1/E1 extension over copper wires



Use the Model 3088 units back-to-back to extend T1 or E1 channels across copper wires. These units are ideal for local loop, Campus, and multi-dwelling/multi-tenant applications.

SPECIFICATIONS

DSL: G.991.2 ITU G.SHDSL Annex A and Annex B, G.994.1 G.hs. nx64 data rates over 2-wire full-duplex to 2.3/4.6 Mbps, symmetrical, TC-PAM encoding. Distance of 32,800 ft (10 km) at 192 kbps to 18,800 ft (5.75 km) at 2.312 Mbps.
DSL Connection: Shielded RJ-45F isolation per IEC 950

DTE Interface: G.703/G.704, V.35, X.21/V.11, T1/FT1, G.703 Co-Directional
DTE Rates: From 64 kbps to 2.3/4.6 mps in user definable increments
Diagnostics: V.54 Loops (LLB, RDL); V.52 compliant BER pattern generator and detector (511/511E)

Management: EIA-561 RJ-45 RS-232, VT-100 CLI, TELNET, Embedded WEB/HTTP, SNMP
Power Supply: External 230 VAC, Universal 90–260 VAC, or -48 VDC input
Compliance: FCC Part 15A, CE Mark, EMC Directive 89/336/EEC, Low-Voltage Directive 73/23/EEC

Op. Temp.: 32–122°F (0–50°C)
Humidity: 5–90%, non-condensing
Dimensions: 4.17W x 1.52Hx5.0L in. (10.6W x 3.9H x 12.7L cm)



I'm Sean, Patton's Director of Sales for North America & Japan. Call me at +1 301.975.1000 when you want to purchase Patton products or if you have questions about our products. You can also send e-mail to sales@patton.com.

ORDERING INFORMATION

3088/C/EU: G.SHDSL RocketLink V.35 with DB-25 interface & M/34F adapter; 100–240 VAC power

3088/D/EU: G.SHDSL RocketLink X.21 with DB-15F interface; 100–240 VAC power

3088/K/EU: G.SHDSL RocketLink G.703/G.704 with dual BNC and/or RJ-48 Interface; 100–240 VAC power

3088/T/EU: G.SHDSL RocketLink T1 with dual BNC and/or RJ-48 interface; 100–240 VAC power

G.SHDSL FRF.5/FRF.8 over ATM NTU
Model 3088FR ATM NTU

The Model 3088FR NTU combines FRF.5 and FRF.8 Frame Relay/ATM conversion with G.SHDSL technology in a compact, high-performance subscriber unit for multi-service, revenue generating, DSL deployment.



The Model 3088FR NTU combines the latest advances in high-speed DSL technology—G.SHDSL—with a potent Frame Relay and ATM core facilitating seamless connection of legacy Frame Relay devices to high-speed ATM networks. Offering Frame Relay-to-ATM conversion using FRF.5 and FRF.8 internetworking, the 3088FR provides standards-

based subscriber interfaces with a choice of synchronous-serial V.35, X.21, or T1/E1 ports. The 3088FR connects seamlessly to any third-party DSLAM, or to another 3088FR for back-to-back operation.

The Patton 3088FR enables interoperable physical access with 2.3 Mbps speeds at nx64 (n=1..36) over a single G.SHDSL G.991.2 pair of wires. The 3088FR—with Annex B support—is based on the ETSI and ITU G.SHDSL G.991.2 standards.

The 3088FR boasts easy installation with console, telnet, and WWW/SNMP management options via its integrated Ethernet port.

SPECIFICATIONS

DSL: G.991.2 ITU G.SHDSL Annex A and Annex B, G.994.1 G.Handshaking, nx64 data rates over 2-wire full-duplex to 2.3 Mbps, symmetrical, TC-PAM encoding. Distance of 32,000 ft (9.8 km) at 192 kbps to 18,000 ft (5.6 km) at 2.312 Mbps.
DSL Connection: Shielded RJ-11F isolation per IEC 950, two-wire, 135-Ohm.
Ethernet Management Connection: 10/100Base-T, auto-sensing, full/half-duplex operation, built-in MDI-X

Serial Interface: V.35—M/34E, X.21—DB15F (DCE/DTE), T1—RJ48C, E1—RJ48C and Dual BNC.
FR to ATM Support: FRF.5 (Frame Relay Network Interworking), FRF.8 (Frame Relay Service Interworking), LMI with ITU Q.933, ANSI T1.617, and Cisco LMI implementation.
Management: EIA-561 RJ-45 RS-232, VT-100 CLI, TELNET, Embedded WEB/HTTP, SNMP, Logging or SMTP on events: POST, POST errors, line & DSL.
ATM Support: UNI 3.0, 3.1, and 4.0 ATM QoS with UBR/CBR/nrt-VBR/rt-VBR

and per-VC queuing and shaping. Peak cell rate shaping on a per-VCC basis up to 32 active VCCs. I.610 OAM network management including AIS/RDI, loop-back and performance monitoring.
Frame Relay: FRF.5, FRF.8, ANSI and CCITT LMI1 with user, network and both Security: Access list determining up to 5 hosts/networks which are allowed to access management system SNMP/HTTP/TELNET
Indicators: 13 LEDs: Power, DSL Link; Sync Serial: TD, RD, CTS, DTR; LAN: TX, RX, 100M Link; Status: NS, ER, TM.

Power Supply: Internal universal 90–260 VAC input or 48 VDC input. Optional external power available.
Compliance: FCC Part 15A, FCC Part 68 (3088FR /T and /K), CE Mark, EMC Directive 89/336/EEC, Low-Voltage Directive 73/23/EEC, EN60950, EN55022 (CISPR 22)
Environment: Temperature: 32–122°F (0–50°C)
Humidity: 5–90%, non-condensing
Dimensions: 7.3 x 6.6 x 1.62 in. (185 x 168 x 41 mm).

FEATURES & BENEFITS

- ✓ **Frame Relay to ATM**—Connect FRADS, routers or any Frame Relay devices to high-speed ATM networks using inexpensive DSLAM ports
- ✓ **Flexible Interfaces**—V.35, X.21, or T1/E1 interface options offers flexibility for all interconnection requirements.
- ✓ **Interoperable with DSLAMs**—Take advantage of Patton reliability whether you connect back-to-back or to a third-party DSLAM.
- ✓ **LEDs & V.52/V.54 Diagnostics**—Easy-to-access toggle switches let you test the link with built-in test modes. LEDs provide clear status at-a-glance
- ✓ **WWW/SNMP Manageable**—Built-in VT-100 console port makes setup a snap, and you can use the embedded HTTP/SNMP agent to manage the Model 3088FR from anywhere in the world.

ORDERING INFORMATION

- 3088FR/RIC/EUI:** ATM to Frame Relay NTU with V.35 interface on M/34 connector
- 3088FR/RID/EUI:** ATM to Frame Relay NTU with X.21 interface on DB-15 connector
- 3088FR/RIK/EUI:** ATM to Frame Relay NTU with T1/E1 interface on both a dual BNC and RJ-48C connector

Why use our 3088FR?

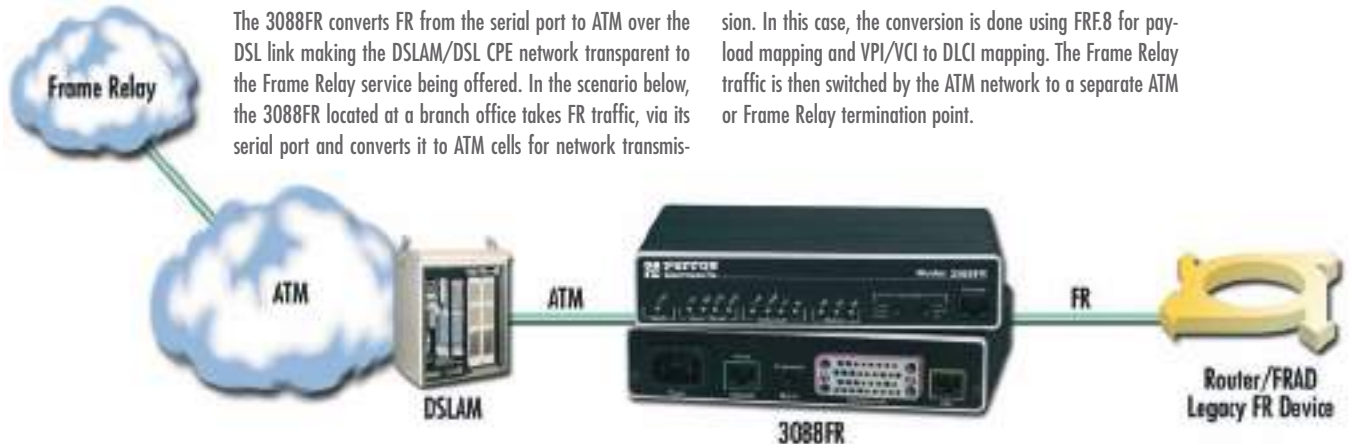

The 3088FR converts FR from the serial port to ATM over the DSL link making the DSLAM/DSL CPE network transparent to the Frame Relay service being offered. In the scenario below, the 3088FR located at a branch office takes FR traffic, via its serial port and converts it to ATM cells for network transmis-

sion. In this case, the conversion is done using FRF.8 for payload mapping and VPI/VCI to DLCI mapping. The Frame Relay traffic is then switched by the ATM network to a separate ATM or Frame Relay termination point.

G.SHDSL Integrated Access Device

Model 3086 ipRocketLink™ IAD

Get high speed, 2-wire, standards-based transmission, and simultaneous sync.-serial and Ethernet/IP for fast, dedicated, always-on access.

The Model 3086 redefines access and sets the new standard for customer premise equipment. Based on the ITU G.SHDSL G.991.2 standard, the Model 3086 ipRocketLink enables nx64 (to 4.6 Mbps) over a single pair of wires while combining standards-based transmission with synchronous-serial, Ethernet, and high speed IP routing — *all in one compact package.*



With Patton's FlexIP™ architecture, The Model 3086 offers V.35/X21 sync.-serial interfaces and 10/100 Ethernet ports. The sync.-serial port is user configurable for V.35 or X.21. Integrated software-selectable DCE/DTE support eliminates messy crossover cables. The Ethernet port gives access to any IP network via ATM, PPP, or Frame Relay. Both interfaces can be simultaneously selected with user-defined bandwidth for each port. The 3086 boasts

easy installation with DIP switch, Telnet, and Web/SNMP management. It provides bridging and routing functionality along with advanced IP features like NAT and firewall, and optional IPSec-based VPN. As part of Patton's family of ipDSL products, the Model 3086 offers a complete, managed, end-to-end system when used with Patton's central site access concentrators.

FEATURES & BENEFITS

- ✓ nx64 speeds to 4.6 Mbps
- ✓ User selectable DCE/DTE V.35/X.21
- ✓ Built-in Ethernet/IP router — *standard*
- ✓ Patton's FlexIP lets users split the bandwidth to use both the serial and the Ethernet interfaces at the same time!
- ✓ Get ATM, PPP, and Frame Relay
- ✓ Interoperable with third-party DSLAMS
- ✓ LEDs and full V.52/V.54 diagnostics
- ✓ Web/SNMP manageable from anywhere in the world via the Internet
- ✓ Powerful routing features like NAT/NAPT, firewall, and DHCP

ORDERING INFORMATION

G.SHDSL IAD router

3086/RIC/UI: Ethernet V.35 M34F port, IP Access Feature Set, and internal AC power supply

3086/RICA/X: Ethernet V.35 DB-25 port, IP Access Feature Set, and internal AC power supply

3086/RID/X: Ethernet X.21 DB-15F port, IP Access Feature Set, and internal AC power supply

3086/RICD/X: Ethernet Selectable X.21/V.35 on DB-25F port, IP Access Feature Set, and internal AC power supply

3086/RIK/X: Ethernet T1/E1 D&I port, IP Access Feature Set, and internal AC power supply

IP/FR and TDM Data Access application

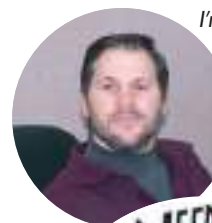
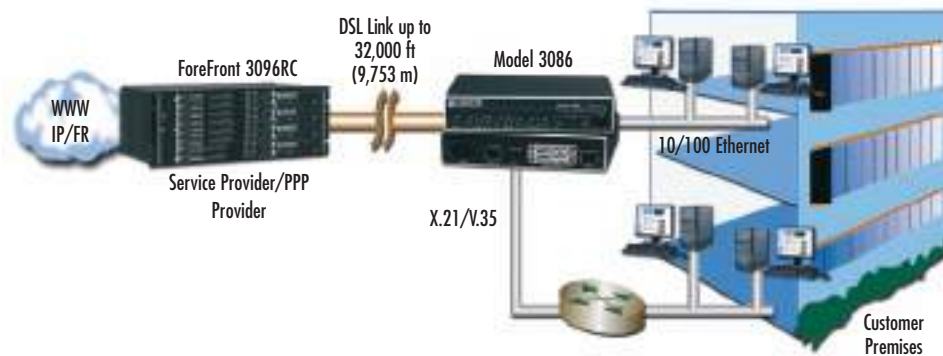

I'm Dave, Patton's Manager of US Technical Support. If you do not find what you need at www.patton.com or in this catalog, or if you have technical questions or comments, please call me at +1 301.975.1007. You can also send e-mail to puckett@patton.com.

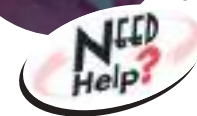

SPECIFICATIONS

DSL: G.991.2 ITU G.SHDSL Annex A and Annex B, G.994.1 G.hs. nx64 data rates over 2-wire full-duplex to 2.3/4.6 Mbps, symmetrical, TC-PAM encoding, Distance of 32,000 ft (9.8 km) at 192 kbps to 18,000 ft (5.6 km) at 2.312 Mbps.

DSL Connection: Shielded RJ-11F isolation per IEC 950

Ethernet Connection: 10/100Base-T, Auto-Sensing, Full/Half-Duplex operation

Management: EIA-561 RJ-45 RS-232, VT-100 CLI, TELNET, Embedded WEB/HTTP, SNMP, Logging or SMTP on events: POST, POST errors, line/DSL, PPP/DHCP, IP MPOA AAL5 and Bridged encapsulation RFC 2684 and RFC 1577 iPoATM, LLC/VC Mux support.

ATM Support: UNI 3.0, 3.1, and 4.0 ATM QoS with UBR/CBR/nrt-VBR/r-VBR and per-VC queuing and shaping.

Peak cell rate shaping on a per-VCC basis up to 32 active VCCs
I.610 OAM network management including AIS/RDI, loop-back and performance monitoring.

Protocol: Enhanced ILM1 4.0 for auto-configuration of ATM PVCs, IP (RFC 741), TCP (RFC 793), UDP (RFC 768), ICMP (RFC 950), ARP (RFC 826), IP Router with RIP (RFC 1058), RIPv2 (RFC 2453), OSPF (RFC 2328) Integrated DHCP Server (RFC

2131). Selectable IP leases and MAC/IP pairings. DHCP relay agent (RFC 2132/RFC 1542) with 8 address pools. DNS Relay, IGMP v1 and v2, IP-in-IP (RFC-2003) encapsulation, Ethernet Bridging.

NAT/NAPT with integrated application support, MultiNat with 1:1 mapping, Many:1, Many:Many mapping, NAT Port/IP redirection and mapping.

Security: DoS Detection/protection, Intrusion detection, Logging of session,

blocking and intrusion events and Real-Time alerts, Password protected system management with a username/password for console and virtual terminal, Packet filtering firewall for controlled access to and from LAN/WAN, Support for 255 rules in 32 filter sets, 16 individual connection profiles, Access list determining up to 5 hosts/networks which are allowed to access management system SNMP/HTTP/TELNET

Power Supply: External universal 90–260 VAC input or -48 VDC
Compliance: FCC Part 15A, CE Mark, EMC Directive 89/336/EEC, Low-Voltage Directive 73/23/EEC

Op. Temp.: 32–122°F (0–50°C)

Humidity: 5–90%, non-condensing
Dimensions: 4.17W x 1.52Hx5.0L in. (10.6W x3.9H x12.7L cm)

ipRocketLink Serial G.SHDSL
Model 3087 3-Point DSL, Serial, Ethernet Bridge/Router

The Model 3087 is a low-cost G.SHDSL Serial Bridge/Router supporting speeds up to 2.3 Mbps over two wires.



The Model 3087 ipRocketLink bridge/router redefines access and sets the new standard for customer premise equipment. Based on European Telecommunications Standardization Institute (ETSI) and International Telecommunications Union (ITU) G.SHDSL G.991.2 standard, the Patton 3087 ipRocketLink enables 2.3 Mbps speeds at nx64 (n=1..36) over a single pair of wires while combining standards based transmission with concurrent synchronous-serial, Ethernet, and high-speed IP routing/bridging... all in one compact package. With Patton's FlexIP™ architecture, the Model 3087 offers V.35, X.21, or T1/E1 Sync-Serial interfaces and a 10/100

Ethernet port. Integrated software selectable DCE/DTE support eliminates messy crossover cables. The Ethernet port enables access to any IP network via ATM, PPP, or Frame Relay. Both interfaces can be simultaneously selected with user-defined bandwidth for each port.

Combining ease-of-use with a full suite of LAN/WAN routing features, the Model 3087 provides selectable bridging or routing functionality along with advanced IP features such as NAT/NAPT, DNS relay, and DHCP server and relay. Numerous firewall features include the ability to filter by IP address and by IP port, support for Intrusion Detection (IDS), and the capability of "blacklisting" offending traffic flows likewise come standard with the unit.

Configurable FR/PPP/IP WAN protocols allow a wide range of choices when connecting equipment via common WAN services. The IPLink supports the latest version of PPP/BCP, transparently negotiating the passing of VLAN traffic.

Application diagram

In a traditional ATM DSLAM network, the traffic from the CPE into the core network stays ATM. In an IPDSLAM network, the CPE ATM traffic is converted to Ethernet/IP at the IPDSLAM.

Therefore, in a traditional DSLAM network, when a user has a router with a serial port such as V.35, X.21 or G.703/G.704, the DSL CPE must support Frame Relay to ATM Internetworking (FRE.5/8). IPDSLAMs typically do not support terminating frame relay traffic. For this reason the Model 3087 is an ideal solution. It supports terminating Frame Relay or PPP from an attached router on the serial port. It then routes or bridges this traffic to the IPDSLAM so that when it gets converted to Ethernet, the traffic can be terminated directly on a BRAS, Ethernet Switch, or MPLS LER.

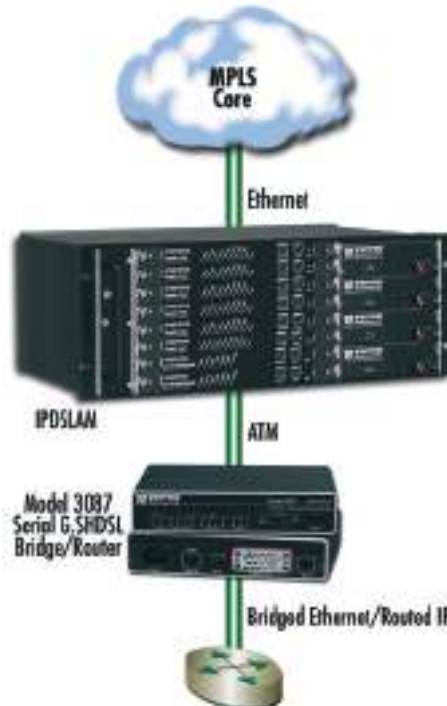

FEATURES & BENEFITS

- ✓ nx64 Rates to 2.3 Mbps—With multiple full-duplex symmetric rates available, users select the bandwidth option they need.
- ✓ Low-Cost Fixed Interfaces—Multiple interface options to choose from: T1/E1 (G.703/G.704), X.21, and V.35.
- ✓ Firewall Support—IDS with blacklisting. ACL support for IP and MAC based filtering.
- ✓ Avoid CES—Route or bridge PPP or Frame Relay traffic
- ✓ NetLink Plug-and-Play—Just plug them in and the link comes up in seconds. With G.Handshake, the CPE unit auto-bauds to rate set at CO.

SPECIFICATIONS

DSL: G.991.2 ITU G.SHDSL Annex A & Annex B, G.994.1 G.hs. nx64 data rates over 2-wire full-duplex to 2.3 Mbps, symmetrical, TC-PAM encoding.
Distances: 32,000 ft (9.8 km) at 192 kbps to 18,000 ft (5.6 km) at 2.312 Mbps.
DSL Connection: Shielded RJ-11F isolation per IEC 950
Ethernet Connection: 10/100Base-T, auto-sensing, full/half-duplex operation, built-in MDI-X
Serial Interface: V.35—M/34E, X.21—DB15F (DCE/DTE), T1—RJ48C, E1—RJ48C, and dual BNC
Management: EIA-561 RJ-45 RS-232, VT-100 CLI, TELNET, Embedded WEB/HTTP, SNMP, Logging or SMTP on events: POST, POST errors, line/DSL, PPP/DHCP, IP MPOA AALS & bridged encapsulation RFC 2684 & RFC 1577 IPoATM, LLC/VC Mux support.
ATM Support: UNI 3.1, and 4.0 ATM QoS with UBR/CBR/nrt-VBR/rt-VBR and per-VC queuing and shaping. • Peak cell rate shaping on a per-VCC basis up to 32 active VCCs • I.610 OAM network management including AIS/RDI, loop-back and performance monitoring.
Protocol: Enhanced LMI 4.0 for auto-configuration of ATM PVCs, IP (RFC 741), TCP (RFC 793), UDP (RFC 768), ICMP (RFC 950), ARP (RFC 826), IP Router with RIP (RFC 1058), RIPv2 (RFC 2453), OSPF (RFC 2328) Integrated DHCP Server (RFC 2131). Selectable IP leases and MAC/IP pairings. DHCP relay agent (RFC 2132/RFC 1542) with 8 address pools. DNS Relay.
**IGMP v1 and v2, IP-in-IP (RFC-2003) encapsulation, Ethernet Bridging. NAT/NAPT with integrated application support, MultiNat with 1:1 mapping, Many:1, Many:Many mapping, NAT Port/IP redirection and mapping. Frame Relay with ANSI and CCITT LMI support including user, network, and both configuration. PPP/PCP and PPP/BCP. Security: DoS Detection/protection. Intrusion detection, Logging of session, blocking and intrusion events and Real-Time alerts, Password protected system management with a username/password for console and virtual terminal, Packet filtering firewall for controlled access to and from LAN/WAN. Support for 255 rules in 32 filter sets. 16 individual connection profiles. Access list determining up to 5 hosts/networks which are allowed to access management system SNMP/HTTP/TELNET
Power Supply: Internal universal 90–260 VAC input or 48 VDC input. Optional external power available.
Compliance: FCC Part 15A, CE Mark, EMC Directive 89/336/EEC, Low-Voltage Directive 73/23/EEC, EN60950, EN55022 (CISPR 22)
Environment: Temp.: 32–122°F (0–50°C); Humidity: 5–90%, non-condensing
Dimensions: 7.3 x 6.6 x 1.62 inch (185 x 168 x 41mm).**

ORDERING INFORMATION

- Serial G.SHDSL Bridge/Router**
3087/RIC/EUI: V.35 port (M34 connector); external UI power supply
3087/RID/EUI: X.21 port (DB15 connector); external UI power supply
3087/RIK/EUI: G.703/G.704 port (BNC & RJ45 connector); external UI power supply
3087/RIC/E48: V.35 port (M34 connector); external 48-VDC power
3087/RID/E48: X.21 port (DB15 connector); external 48-VDC power
3087/RIK/E48: G.703/G.704 port (BNC & RJ45 connector); external 48-VDC power

G.SHDSL FRF.5/FRF.8 Over ATM IAD

Model 3086FR IpRocketLink™ ATM IAD

Combines FRF.5 and FRF.8 Frame Relay/ATM conversion with G.SHDSL technology in a compact, high performance subscriber unit for multi-service, revenue generating, DSL deployment.



The Patton Model 3086FR IAD combines the latest advances in high speed DSL technology, G.SHDSL, with a potent IP, FR, PPP and ATM core facilitating simultaneous connection of legacy Frame Relay devices as well as routed IP services to high speed ATM networks.

ORDERING INFORMATION

Model 3086FR G.SHDSL IAD, FRF-5 & FRF-8

3086FR/RIC/48: V.35 (M34) + ETH, 48 VDC

3086FR/RIC/EU: V35/M34 + ETH; Ext Pwr 120–220 VAC PS

3086FR/RICA/EU: V35/DB25 + ETH; Ext Pwr 120–220 VAC

3086FR/RID/EU: X.21/DB15 + ETH; Ext Pwr 120–220 VAC

Based on the ETSI and ITU G.SHDSL G.991.2 standard, the 3086FR enables 2.3 Mbps speeds at nx64 (n=1..36) over a single pair of wires. The 3086FR boasts a dual subscriber interface with a standard 10/100 Ethernet and a choice of Synchronous-Serial V.35, X.21 or T1/E1 ports. Together, these interfaces can be concurrently configured for FR-to-ATM conversion using FRF.5 and FRF.8, as well as IP routing or Ethernet bridging—all in one compact package.

The 3086FR boasts easy installation with console, Telnet, and WWW/SNMP management. It provides bridging and routing functionality, along with advanced IP features such as DHCP and Firewall (IDS, Filtering, NAT).

3086FR/RIK/48: G.703/G.704 + ETH; Ext Pwr 48 VDC (3rd party compatible)

3086FR/RIT/48: T1 + ETH; Ext Pwr 48 VDC (3rd party compatible)

3086FR/RIT/EU: T1 + ETH; Ext Pwr 120–220 VAC (3rd party compatible)

FEATURES & BENEFITS

- ✓ **Frame Relay to ATM Conversion**—Connect FRADS, routers or any Frame Relay devices to high speed ATM core networks using inexpensive DSLAM ports
- ✓ **Built-in Ethernet/IP Router Standard**—With Patton's FlexIP architecture, route from any to any port using FR, PPP, Ethernet, and ATM
- ✓ **Firewall**—The 3086FR comes standard with Intrusion Detection (IDS), Access Control Lists (ACL), IP & port filtering and NAT/PAT
- ✓ **Interoperable with Third-Party DSLAMs**—Take advantage of Patton feature richness to deploy multiple revenue generating services over any third-party DSLAM

SPECIFICATIONS

DSL: G.991.2 ITU G.SHDSL Annex A and Annex B, G.994.1 G.Handshaking, nx64 data rates over 2-wire full-duplex to 2.3 Mbps, symmetrical, TC-PAM encoding.

Distance of 32,000 ft (9.8 km) at 192 kbps to 18,000 ft (5.6 km) at 2.312 Mbps.

DSL Connection: Shielded RJ-11F isolation per IEC 950, two-wire, 135-Ohm

Ethernet Connection: 10/100Base-T, auto-sensing, full/half-duplex operation, built-in MDI-X

Serial Interface: V.35—M/34F, X.21—DB15F (DCE/DTE), T1—RJ48C, E1—RJ48C and Dual BNC

FR to ATM Support: FRF.5 (Frame Relay Network Interworking), FRF.8 (Frame Relay Service Interworking), LMI with ITU Q.933, ANSI T1.617, and Cisco LMI implementation.

Management: EIA-561 RJ-45 RS-232, VT-100 CLI, TELNET, Embedded WEB/HTTP, SNMP, Logging or SMTP on events: POST, POST errors, line/DSL, PPP/DHCP, IP MPOA AAL5 and Bridged encapsulation RFC 2684 and RFC 1577 IPoATM, LLC/VC Mux support.

ATM Support: UNI 3.0, 3.1, and 4.0 ATM QoS with UBR/CBR/nrt-VBR/rt-VBR and per-VC queuing and shaping. Peak cell rate shaping on a per-VC basis up to 32 active VCs I.610 OAM network management including AIS/RDI, loop-back and performance monitoring.

Protocol: Enhanced LMI 4.0 for auto-configuration of ATM PVCs, IP (RFC 741), TCP (RFC 793), UDP (RFC 768), ICMP

(RFC 950), ARP (RFC 826), IP Router with RIP (RFC 1058), RIPv2 (RFC 2453), OSPF (RFC 2328) Integrated relay agent (RFC 2132/RFC 1542) with 8 address pools. DNS Relay, IGMP v1 and v2, IP-in-IP (RFC-2003) encapsulation, Ethernet Bridging, NAT/NAPT with integrated application support, MultiNat with 1:1 mapping, Many:1, Many:Many mapping, NAT Port/IP redirection and mapping. Security: DoS Detection/protection, Intrusion detection, Logging of session, blocking and intrusion events and Real-Time alerts, Password protected system management with a username/password for console and virtual terminal, Packet filtering firewall for controlled access to and from LAN/WAN, Support for 255 rules in 32 filter sets, 16 individual connection profiles. Access list determining up to 5 hosts/networks which are allowed to access management system SNMP/HTTP/TELNET

Power Supply: Internal universal 90–260 VAC input or 48 VDC input. Optional external power available.

Compliance: FCC Part 15A, FCC Part 68 (3086FR/RIT and /RIK), CE Mark, EMC Directive 89/336/EEC, Low-Voltage Directive 73/23/EEC, EN60950, EN55022 (CISPR 22)

Temp.: 32–122°F (0–50°C)

Humidity: 5–90%, non-condensing

Dimensions: 7.3" x 6.6" x 1.62" (185mm x 168mm x 41mm).

Application—FR and IP traffic over ATM

The 3086FR converts Frame Relay traffic from the serial port into ATM format for transmission over the DSL link. This protocol mapping function makes the DSLAM/DSL CPE network transparent to the Frame Relay service connected to the serial port. Simultaneously, the 3086FR provides a full-service routed or bridged connection between the LAN (connected to the 10/100 Ethernet port) and the supporting DSLAM/ATM network (connected via the G.SHDSL interface).

In the scenario illustrated at right, the 3086FR is located at a branch office and encapsulates FR frames received at the serial port into ATM cells for transmission over the G.SHDSL link. In this example, the conversion is done using the procedures specified in the FRF.5 Implementation Agreement. Simultaneously, the 3086FR routes (or bridges) traffic from the Ethernet LAN to the G.SHDSL port, also encapsulated into ATM

cells. Traffic from the Serial and Ethernet ports is sent over the DSL link. Traffic from each port is delivered on its own ATM virtual circuit, as defined by a unique VPI/VCI combination. This mapping allows the core ATM network to switch the IP traffic to the Internet via a core router. Since the 3086FR supports PPPoE and PPPoA, the traffic can even pass through an authentication server. Finally, the ATM network switches the frame relay traffic to a separate ATM or Frame-Relay termination point.

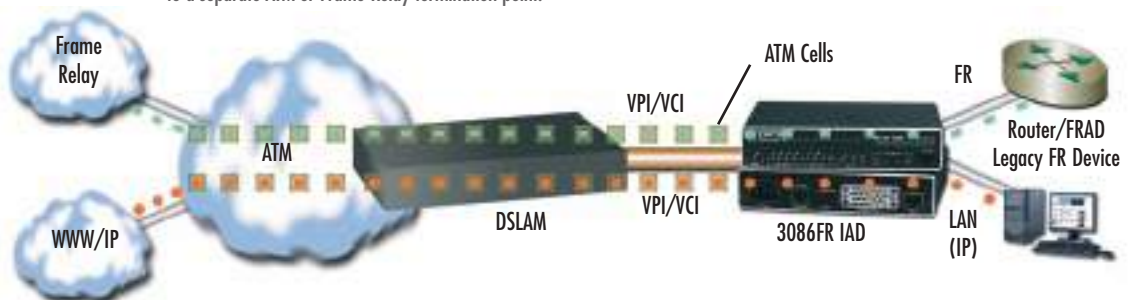

G.SHDSL High-Speed Routers

Models 3201 & 3241 DiamondLink™

High speed networking to deliver IP access via G.SHDSL technology.

As the cost-per-port for access is collapsing under continuous downward pressure, service providers are looking for proven, flexible, easy-to-use and powerful solutions. Digital subscriber line (DSL) technology transforms traditional inexpensive copper lines into high speed data connections and delivers the access guaranteed.

DSL is particularly valuable as it addresses the immediate needs of business and consumers alike. For high speed Internet access and LAN-to-LAN internetworking, DSL has proven to be cost-effective and quickly provisioned.

The 3201 & 3241 G.SHDSL routers offer standards-based DSL that supports the fundamental and advanced access requirements needed in the market today. These needs are:

- Provide a routed packet-based CPE with IP centric services and functionality.



- Support compatibility with the ability to connect to standard DSLAMs using G.SHDSL.
- Utilize the preferred management method for ISP/CLEC/Carrier environments with the ability to manage devices from any workstation or PC across the Internet.

FEATURES & BENEFITS

- ✓ G.SHDSL speeds to 4.6 Mbps over just a single twisted pair
- ✓ Distances up to 31,000 feet (9,449 m)
- ✓ G.SHDSL interoperability with third-party DSLAMS
- ✓ 10/100 Ethernet port with MDI-X switch to allow easy connection to any computer or LAN
- ✓ Web/SNMP manageable from anywhere in the world via the Internet
- ✓ Powerful routing features like NAT/NAPT, firewall, and DHCP
- ✓ Plug-and-play operation for easy deployment
- ✓ VT-100 port provides convenient local management



I'm Danny, one of Patton's Support Engineers. If you're having a problem with a Patton product, I'll find the solution quickly. To buy one of these G.SHDSL CPEs, call +1 301.975.1000 or send e-mail to sales@patton.com.

Typical application



SPECIFICATIONS

DSL: G.991.2 ITU G.SHDSL Annex A and Annex B, G.994.1 G.hs. nx64 data rates over 2-wire full-duplex to 2.3/4.6 Mbps, symmetrical, TC-PAM encoding. Distance of 32,000 ft (9.8 km) at 192 kbps to 18,000 ft (5.6 km) at 2.312 Mbps.

DSL Connection: Shielded RJ-11F isolation per IEC 950

Ethernet Connection: 10/100Base-T, Auto-Sensing, Full/Half-Duplex operation

Management: EIA-561 RJ-45 RS-232, VT-100 CLI, TELNET, Embedded WEB/HTTP, SNMP Logging or SMTP on events: POST, POST errors, line/DSL, PPP/DHCP, IP MPOA AAL5 and Bridged

encapsulation RFC 2684 and RFC 1577 IPoATM, LLC/VC Mux support.

ATM Support: UNI 3.0, 3.1, and 4.0 ATM QoS with UBR/CBR/nrt-VBR/rt-VBR and per-VC queuing and shaping.

Peak cell rate shaping on a per-VCC basis up to 32 active VCCs
1.610 OAM network management including AIS/RDI, loop-back and performance monitoring.

Protocol: Enhanced ILMI 4.0 for auto-configuration of ATM PVCs, IP (RFC 741), TCP (RFC 793), UDP (RFC 768), ICMP (RFC 950), ARP (RFC 826), IP Router with RIP (RFC 1058), RIPv2 (RFC 2453), OSPF (RFC 2328) Integrated DHCP Server (RFC

2131). Selectable IP leases and MAC/IP pairings. DHCP relay agent (RFC 2132/RFC 1542) with 8 address pools. DNS Relay, IGMP v1 and v2. IP-in-IP (RFC-2003) encapsulation, Ethernet Bridging.

NAT/NAPT with integrated application support, MultiNat with 1:1 mapping, Many:1, Many:Many mapping, NAT Port/IP redirection and mapping.

Security: DoS Detection/protection. Intrusion detection, Logging of session, blocking and intrusion events and Real-Time alerts. Password protected system management with a username/password for console and virtual terminal, Packet filtering firewall for controlled access to

and from LAN/WAN. Support for 255 rules in 32 filter sets. 16 individual connection profiles. Access list determining up to 5 hosts/networks which are allowed to access management system
SNMP/HTTP/TELNET

Power Supply: External universal 90–260 VAC input or -48 VDC

Compliance: FCC Part 15A, CE Mark, EMC Directive 89/336/EEC, Low-Voltage Directive 73/23/EEC

Op. Temp.: 32–122°F (0–50°C)

Humidity: 5–90%, non-condensing
Dimensions: 4.17W x 1.52Hx5.0L in. (10.6W x3.9H x12.7L cm)

visit us online
www.patton.com

FAST Delivery From Your AUTHORIZED DISTRIBUTOR!

PATTON
Electronics Co.

G.SHDSL.bis Business Router

Model 3210 ILink™ G.SHDSL.bis VPN Router

This ILink™ G.SHDSL.bis VPN Router optimizes and secures information by applying VPN encryption and QoS/CoS traffic management to G.SHDSL.bis-based broadband networks.



The ILink™ G.SHDSL.bis VPN Router is a next generation business-class G.SHDSL router that addresses both the security and the traffic prioritization needs of enterprises while providing complete broadband integration with existing DSLAM networks. VPN routers enable the secure communication between remote offices, home offices, and mobile users across insecure IP networks such as the Internet. The 3210 takes it one step further and integrates quality of service (QoS).

ILink G.SHDSL.bis VPN Routers implement a comprehensive security environment. By supporting ESP as well as AH, ILink VPN Routers provide data integrity, authentication, anti-replay and data confidentiality to any traffic flow. DES, 3DES, and AES provide standard encryption up to 256 bits. Firewall capabilities of the ILink VPN Routers include Access Control Lists (ACLs), IP address and port filtering, and protection against Denial of Service (DoS) attacks.

QoS features include ToS/DiffServ marking and the configuration of eight service class tags per IEEE 802.1p/Q. With traffic scheduling and shaping, create dedicated bandwidth guarantees, configurable burst tolerance, and policing to include excess traffic discard. IP fragmentation is configurable to help minimize jitter in traffic flows.

NAT, NAPT, DNS relay, dynDNS, and DHCP server further add to the capabilities of the ILink G.SHDSL VPN Router.

FEATURES & BENEFITS

- ✓ G.SHDSL.bis—From 192 kbps to 5.7 Mbps over 2-wire, dry copper networks.
- ✓ Versatile ATM configurations—Support PPPoE, PPPoA as well as RFC 1384/2684.
- ✓ Dual 10/100 Ethernet Ports—With Dual 10/100 Ethernet, auto-MDI ports easily connect to the LAN and a DMZ.
- ✓ Per Flow QoS—Traffic rates are set through ACLs that shape and police in ingress and egress directions.
- ✓ Stateful Firewall Inspection—Stateful firewall inspection is accomplished through ACLs that filter by source and destination IP address, IP port and protocol.
- ✓ VLAN Tagging—VLAN tagging and processing is configurable on any PVC channel or Ethernet port.
- ✓ Easy Management via an HTTP/web interface, a CLI accessible via the VT100 console or through Telnet/SSH.

Application diagram

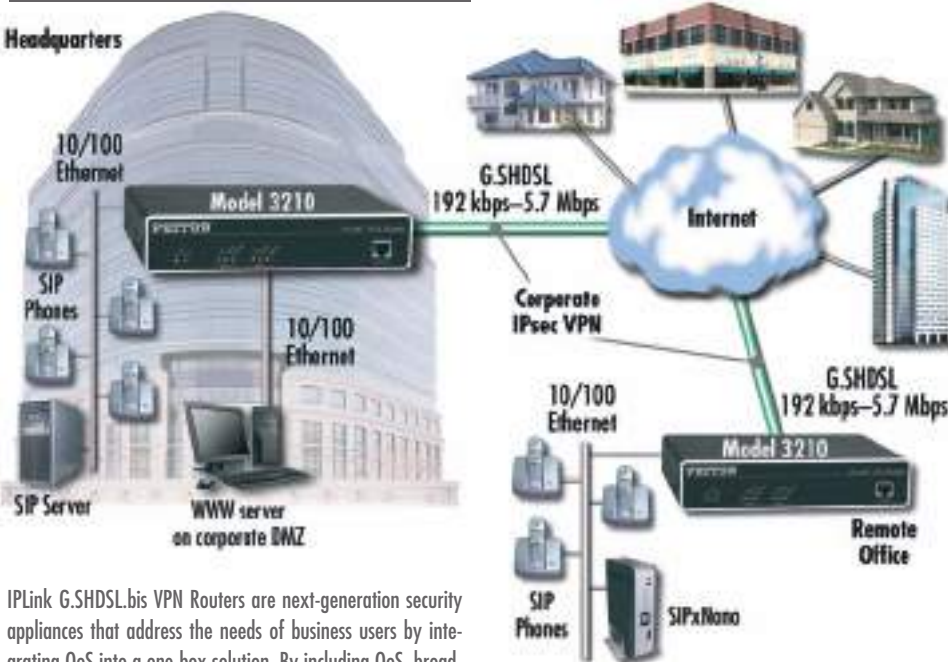

ILink G.SHDSL.bis VPN Routers are next-generation security appliances that address the needs of business users by integrating QoS into a one-box solution. By including QoS, broadband connections can be put to dual-use without impacting the quality of business data flows.

ORDERING INFORMATION

3210/EU: G.SHDSL.bis VPN Router with 2 Ethernet ports, external UI power

SPECIFICATIONS

G.SHDSL port: ITU-T G.991.2 including Amendment 2, Annex A, B, E, F; ITU-T G.994.1 (G.Handshake); Classical Internet Protocol over ATM (RFC 1577/2225); PPPoE over ATM (RFC 2516); Routed IP over ATM (RFC 2684/1483); ATM QoS: UBR, CBR, and VBR-rt Support; TR-037 & ILM1 4.0 Auto-config support

LAN Ethernet Ports: Two 10/100BaseT (RJ-45 connector); auto-negotiating; half or full duplex operation with automatic MDI/MDI-X

Management: CLI via Telnet; TFTP for Software upgrade and configuration upload; SNMPv1; HTTP/web browser

Protocols: IP (RFC 741), TCP (RFC 793), UDP (RFC 768), ICMP & ICMP Redirect (RFC 792), ARP (RFC 826), IP Router with IPv4 (RFC 1058), IPv6 (RFC 2453), programmable static routes, Integrated DHCP Server (RFC 2131), DNS Relay (RFC 1631), IEEE 802.1p VLAN Tagging, NAT/NAPT (RFC 1631/2391)

Security: IPsec including AH and ESP, DES, 3DES, and AES encryption. Access

Control Lists (ACLs), IP port and address filtering both by source and destination. DoS Detection. Password protected system management with a username/ password for console and virtual terminal.

Power Supplies: External universal 90–260 VAC input or 48 VDC input. (Optional internal universal 90–260 VAC input.)

Compliance: CE Mark; Safety: UL60950-1, CSA 22.2 6095001, IEC/EN60950-1. Universal AC units are US NRTL Listed; EMC Emissions: FCC Part 15 Class A; EN55022 Class A; EMC Immunity: EN55024

Environment: Operating temp.: 0–40°C (32–104°F); Humidity: 5–90% non-condensing

Dimensions & Weight

7.3W x 1.6H x 6.1D in.
(18.5H x 4.1W x 15.5D cm)
30.5 oz./500g (models with internal power); 24.4 oz./400g (models with external power; no power supply)

See Pg 134



VDSL Data & Voice Modems

Model 1058 Series Standalone & Rack Cards

Extend the reach of your network up to 4,656 ft (1.42 km) at 12.5 Mbps over a single voice-grade twisted-pair wire.



The Model 1058DV provides high speed Ethernet and voice connections between LANs or other network enabled devices. The 1058DV's line-sharing capabilities enable users

to download files from the Internet, surf the web, and answer e-mail messages while simultaneously talking on the phone or using a fax machine. VDSL's unparalleled performance supports these services at distances up to 4,656 ft (1.42 km) over a single pair of voice-grade wire—all at 12.5 Mbps!

The Model 1058DV is compact, easy to install, and transparent to higher layer protocols. Plug-and-play made easy—simply make the Ethernet, voice (POTS/ISDN), VDSL link, and power connections, and you're ready to operate. The Model 1058DV's will auto-sense and configure for 10Base-T or 100Base-T, as well as full or half-duplex Ethernet operation. No configuration required!

With full service integration over an existing copper infrastructure, the Model 1058DV is an effective solution for providing data and voice services for educational facilities, corporate and government offices, military installations, industrial complexes, CLECs, and ISPs.

What is VDSL?

VDSL (very high bit-rate digital subscriber line) is the fastest DSL technology currently available. Depending on the intended applications, VDSL can be configured for symmetrical or asymmetrical operation. VDSL's high bandwidth allows for applications such as high-definition television, video-on-

demand (VOD), high quality video conferencing, medical imaging, fast Internet access, and regular voice telephone services all over a single voice-grade twisted pair. Achievable VDSL distances may vary depending on data rate, gauge/type of wire, and noise/cross-talk environment.

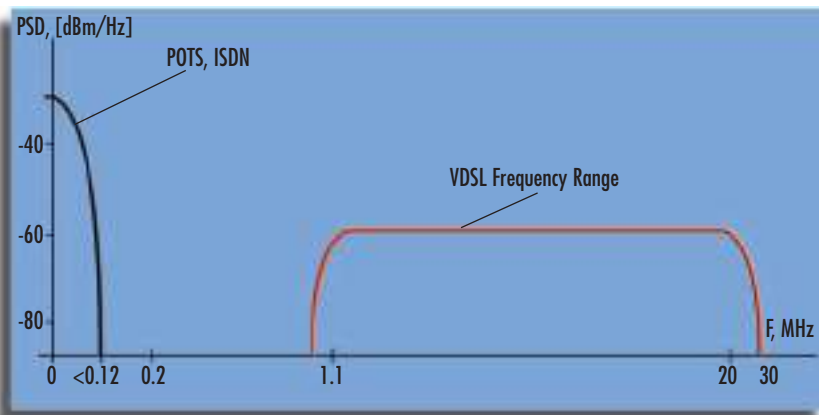

Frequency division multiplexing (FDM) lets one pair of wires simultaneously transport data (VDSL) and voice (POTS/ISDN) traffic. Lower frequencies are reserved for voice (POTS/ISDN); higher frequencies for data (VDSL)

SPECIFICATIONS

VDSL line interface: RJ-45 (pin 4 = ring; pin 5 = tip); optional two-position removable terminal block (supports 19–26 AWG or 0.9–0.4 mm wire)
Ethernet interface: 8-position shielded RJ-45. Auto-sensing 10/100Base-T with half or full-duplex operation
POTS/ISDN interface: RJ-45 (pin 4 = ring; pin 5 = tip)

Protocol: Transparent to high layer protocol. Supports 802.1Q VLAN tagging
Modulation: QAM (Quadrature Amplitude Modulation)
Duplexing Method: FDD (Frequency Division Duplexing)
Frequency Range: VDSL: 1–8 MHz; POTS/ISDN: 0–120 kHz
Transmission: VDSL line rate: 12.5 Mbps; Data rate: 10 Mbps full-duplex

Surge suppression: VDSL line max current surge: 20kA (8/20µs) gas tube
Power Supply: External AC and DC options: 120VAC, and universal input (UI)—100–240 VAC, or DC-48 VDC, -24 VDC, and -12 VDC
Compliance: FCC Part 15A and Part 68A & B (1058DV version only), CE Mark, EMC Directive 89/336/EEC, Low-Voltage Directive 73/23/EEC

Environment: Temperature: 32–122°F (0–50°C)
Humidity: Up to 90% non-condensing
Dimensions: Standalone: 1.5H x 4.13W x 3.75D in. (3.81H x 10.5W x 9.53D cm); Rack Card: 3.0H x 0.83W x 7.84D in. (7.6H x 2.1W x 19.9D cm)
Weight: Standalone 0.4 lbs (0.18 kg) without power supply; Rack card: 0.3 lbs (0.14 kg) with rear card

FEATURES & BENEFITS

- ✓ Ethernet Extension—Overcome the 328 ft (100 m) limitation of Ethernet with a full-duplex 12.5 Mbps link at distances up to 4,656 ft (1.42 km).
- ✓ Auto Sensing Full-Duplex Ethernet—Auto 10 or 100 Base-T and full or half-duplex Ethernet operation.
- ✓ Transparent LAN Bridging—Passes higher layer protocols and supports 802.1Q VLAN tagging.
- ✓ Automatic Learning, Aging, and Filtering—Only allows packets with addresses outside the LAN to be forwarded.
- ✓ Line Sharing—Offer POTS/ISDN & Ethernet services over a single pair of voice-grade wire.
- ✓ CP units are compatible with Model 3324 VDSL Access Concentrator/Switch (see page 80)



24-port VDSL concentrator



Symmetric or asymmetric variable-rate VDSL

Line rates can be altered on the standalones and rack cards to differentiate services and to increase the distance of the individual links (see page 92 for line rates).

ORDERING INFORMATION

1058 Fixed Rate VDSL Ethernet Extender
1058DV/CO/EUI: CO VDSL Modem; Voice & Data; RJ-45 Line; 100–240 VAC

1058DV/CP/EUI: CP VDSL Modem; Voice & Data; RJ-45 Line; 100–240 VAC

1058 Fixed Rate VDSL Kit
1058DV/EUI-2PK: CO & CP VDSL Modem Kit; RJ-45 Line; 100–240 VAC

1058 Environmentally Hardened Fixed Rate VDSL Modem
ET1058DV/CP/UI: Extended Temp -40 to 85°C VDSL CP VDSL Modem; 100–240 VAC
EC1058DV/CP/UI: Environmentally Controlled 0 to 85°C CP VDSL Modem; 100–240 VAC
EH1058DV/CP/UI: Environmentally Hardened 0 to 50°C CP VDSL Modem; 100–240 VAC

Variable-Rate VDSL Modem

Model 1068

The Model 1068 provides variable-rate high speed connectivity of voice and data signals over a single voice-grade twisted pair.

The Patton Model 1068 VDSL Modem provides up to 16 Mbps of high speed Ethernet and voice services between LANs or other network enabled devices over a single twisted-pair. The Model 1068 is the only variable-rate asymmetrical/symmetrical standalone modem solution available today. The ability to select various asymmetrical and symmetrical rates allows the Model 1068 to satisfy a broad range of applications. Popular applications for the Model 1068 in symmetrical mode include video conferencing, interactive video, and telecommuting. The primary use for the Model 1068 in asymmetrical mode is delivering Internet service to residential customers.

The 1068DV features a built-in POTS/ISDN splitter and line sharing capabilities that allow for simultaneous use of voice and data services. This means that end-users can download files from the Internet, surf the WWW, and answer e-mail messages while talking on the phone or faxing documents.

The Model 1068s are sold in pairs and require one unit for the local site, or *central office*, and one unit for the remote site (*customer premise*) for proper operation. Model 1068 standalone units are ideal for low density point-to-point applications.



For high density applications, the standalone units can be used with the Model 1068 rack cards and Patton's 1001 Rack System to provide a concentrated VDSL solution. If you want to take your network and voice connections farther and faster over existing copper and eliminate the expense of fiber, Patton's Variable Rate VDSL modems are the products for you!

Just plug it in, power it on, and play!



FEATURES & BENEFITS

- ✓ Low cost plug-and-play solution for campus-wide network extension and delivery of last-mile ISP services over Ethernet
- ✓ Extends Ethernet distances up to 1 mile (1.61 km) over 2-wire 24-AWG unconditioned lines
- ✓ Switch selectable asymmetrical or symmetrical line rates up to 16.67 Mbps
- ✓ Auto-sensing 10Base-T or 100Base-TX
- ✓ Supports full- or half-duplex Ethernet
- ✓ Transparent LAN bridging (Passes 802.1Q (VLAN) packets)
- ✓ Automatic learning, aging, and filtering source address table
- ✓ Standalone and rack mounted versions
- ✓ CP units are compatible with Model 3324 VDSL Access Concentrator/Switch (see page 80)

Symmetric or asymmetric variable-rate VDSL

Line rates can be altered on the standalones and rack cards to differentiate services and to increase the distance of the individual links.

Asymmetric		
Line Rates		Distance in ft (m)
Upstream (Mbps)	Downstream (Mbps)	26 AWG (0.4 mm)
1.56	4.17	6,000 (1,829)
1.56	9.38	5,500 (1,676)
2.34	16.67	5,000 (1,524)

Symmetric		
Line Rates		Distance in ft (m)
Upstream (Mbps)	Downstream (Mbps)	26 AWG (0.4 mm)
6.25	6.25	4,500 (1,372)
9.38	9.38	4,150 (1,265)
12.50	12.50	4,000 (1,220)
16.67	16.67	3,300 (1,006)

Typical application



SPECIFICATIONS

VDSL Line Interface: RJ-45 or terminal block

Ethernet Interface: Shielded RJ-45

POTS-ISDN Interface: RJ-45 (pin 4 = ring, pin 5 = tip)

Modulation: QAM (Quadrature Amplitude Modulation)

Frequency Range: VDSL: 1–8 MHz
POTS/ISDN: 0–120 kHz

Transmission: Switch selectable asymmetrical and symmetrical line rates up to 16.67 Mbps

Surge suppression: VDSL 20kA (8/20ms) gas tube

Power Supply: External AC: UI (100–240); DC: -48, -24, and -12 VDC (DC optional)

Dimensions:

1.5H x 4.13W x 3.75D in.
(3.81H x 10.5W x 9.53D cm)

Weight: 0.4 lbs (0.18 kg) without power supply

Typical application

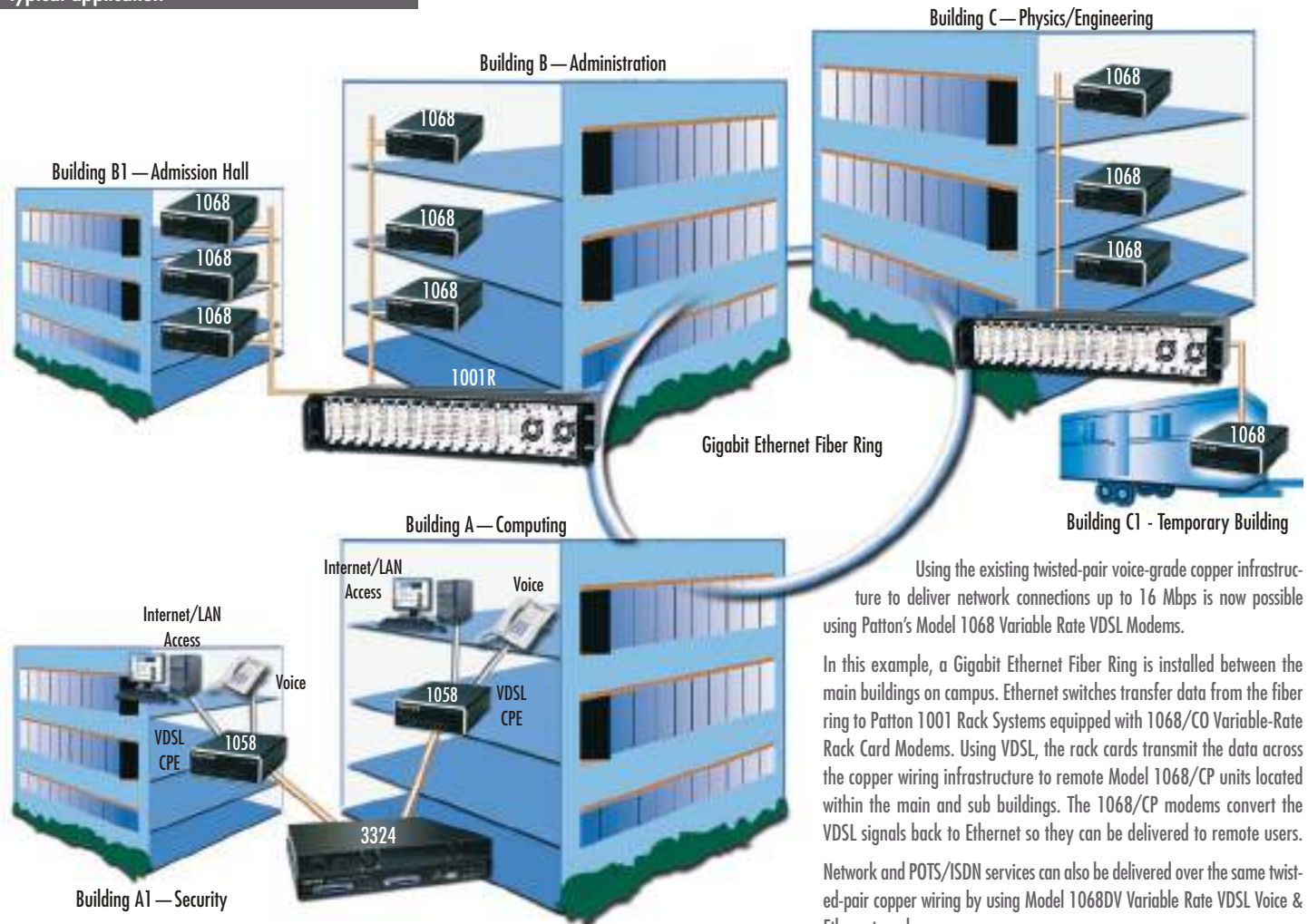

Using the existing twisted-pair voice-grade copper infrastructure to deliver network connections up to 16 Mbps is now possible using Patton's Model 1068 Variable Rate VDSL Modems.

In this example, a Gigabit Ethernet Fiber Ring is installed between the main buildings on campus. Ethernet switches transfer data from the fiber ring to Patton 1001 Rack Systems equipped with 1068/CO Variable-Rate Rack Card Modems. Using VDSL, the rack cards transmit the data across the copper wiring infrastructure to remote Model 1068/CP units located within the main and sub buildings. The 1068/CP modems convert the VDSL signals back to Ethernet so they can be delivered to remote users.

Network and POTS/ISDN services can also be delivered over the same twisted-pair copper wiring by using Model 1068DV Variable Rate VDSL Voice & Ethernet modems.

ORDERING INFORMATION

1068 Multi-Rate VDSL Modem

1068DV/CO/EU: CO VDSL Modem; RJ-45 Line; 100–240 VAC

1068DV/CP/EU: CP VDSL Modem; RJ-45 Line; 100–240 VAC

1068DV/CO/TB45/EU: CO VDSL Modem; Terminal Block & RJ-45 Line; 100–240 VAC

1068DV/CP/TB45/EU: CP VDSL Modem; Terminal Block & RJ-45 Line; 100–240 VAC

1068 Multi-Rate VDSL Kit

1068DV/EU-2PK: CO & CP VDSL Modem Kit; RJ-45 Line; 100–240 VAC

1068DV/TB45/EU-2PK: CO & CP VDSL Modem Kit; Terminal Block & RJ45 Line; 100–240 VAC

1068 Environmentally Hardened Multi-Rate VDSL Modem

E11068DV/CP/UI: Extended Temp -40 to 85°C CP VDSL Modem; 100–240 VAC

EC1068DV/CP/UI: Environmentally Controlled 0 to 85°C CP VDSL Modem; 100–240 VAC

EH1068DV/CP/UI: Environmentally Hardened 0 to 50°C CP VDSL Modem; 100–240 VAC

1068 Rack Card

1068DVRC/CP: RJ-45F & Terminal Block

1068DVRC/CO: RJ-45F & Terminal Block

The Model 1068 rack cards plug into the Model 1001 rack system (see page 110)

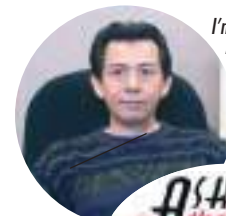

I'm Jose, Patton's Technical Solutions Manager for Latin America. If you have any questions about products or applications using these technologies, please call me at +1 301.975.1000, x142, or send e-mail to jose@patton.com.



ISDL DACS Provides Quad T1/E1 & 24 ISDL Ports

Model 3092

The Patton 3092 ISDL DACS provides 24 ISDL ports, each supporting 64/128/144 kbps dedicated connections.



The Model 3092 ISDL Digital Access and Cross-Connect System (DACS) is the efficient, rack-mountable solution for ILECs/PTTs expanding their access services via ISDL dedicated links. The Model 3092 combines ISDL ports for concentration to multiple TDM WAN ports with total flexibility in mapping the ISDL channels and WAN time slots. The Model 3092 is extremely reliable due to its convection cooling (with no fans or other moving parts to fail) and dual-redundant power supplies.

The Model 3092 ISDL DACS links up 24 ISDL circuits to multiple T1/E1 WAN ports with completely flexible any-to-any nx64

grooming. Each 64/128/144-kbps ISDL port offers user selectable nx64 data rates. User data is then groomed to any channel within the system—including another DSL port! Completely transparent to data, the provider can offer multiple services (ATM/IP/FR) to each user. The entire system is easily managed through its integrated SNMP/HTTP-based network management system (NMS). Using standards-based ISDL, the Model 3092 is compatible with third-party ISDL modems.

With its hassle-free operation, convenient end-to-end setup, high-density and unsurpassed reliability, the Model 3092 ISDL DACS is ready to get your customers up to speed.

FEATURES & BENEFITS

- ✓ Grooms 24 ISDL connections to any WAN timeslot or other ISDL timeslot
- ✓ Four T1/E1 WAN uplink ports connect to TDM backbone network connections
- ✓ Multiple, configurable alarms reporting via remote SNMP traps, front panel LEDs, 3-contact relay, and NMS pages
- ✓ SNMP/HTTP network management capabilities enable you to configure the Model 3092 and the remote ISDL modems from any location in the world.
- ✓ Compact 1U chassis' convection cooled design allows stacking with no fans or other moving parts to fail
- ✓ Dual-redundant power supplies provide for high reliability with dual load-sharing power supplies.

Refer to page 92 for detailed DISTANCE information and compatible ISDL CPE units.



Application diagram

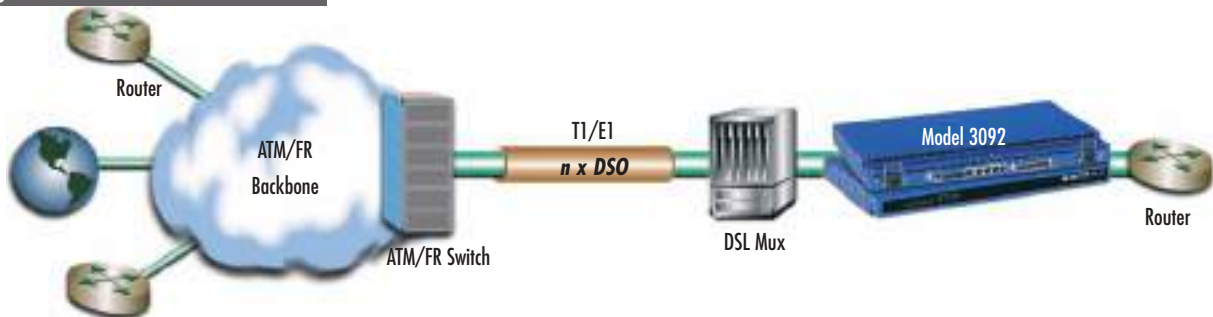

SPECIFICATIONS

ISDL ports: 24 ports (RJ-21X 50-pin connector), each port 64/128/144 kbps

WAN ports: 4 WAN ports: E1 (HDB3/AMI line coding), T1 (AMI/B8ZS line coding); connects to ATM/FR/DDN/IP backbone networks

Ethernet Port: One 10/100Base-T (RJ-45 connector)

ISDL Modems: Patton 1092A and 1082, Motorola UTA-220, and RAD ASM-31

Front Panel Indicators: LEDs for power, CPU, system, Ethernet, External clock, test mode, DSL, and WAN ports frame and error status

WAN Clocking: Internal, Network (from E1/T1 WAN port), External BITS (Building Integrated Timing Supply) Clock Source via 3-pin terminal block

ISDL Clocking: Provides clocking to the remote ISDL NTUs/Modems

Power Supplies: Dual-redundant universal AC/DC (fixed);

AC power: 100–240VAC (60/60 Hz); DC power: -40 to -72VDC

Management Services: HTTP, SNMP, TELNET, Ethernet, RS-232 Console Port, SYSLOG Client, Remote Software Upgrade via FTP

Alarm Reporting: Configurable alarms; Remote SNMP Traps; Front Panel LEDs; 3-Contact Relay (3-pin terminal block)

Compliance: Safety: UL/CSA per UL1950 (METS) Canadian cMET and CS-03, EMC Directive 89/336/EEC, Low-Voltage Directive 73/23/EEC (EN 60950), FCC Part 15, CE Mark, CTR12, CTR13, FCC Part 68.

Environment: Operating temperature: 0–40°C (32–104°F); Humidity: 5–90% non-condensing

Dimensions: 19.00 W x 12.60 D x 1.75 H in. (48.25 W x 32 D x 4.44 H cm)

ORDERING INFORMATION

3092/24/RUI: 24 Port ISDL DACS with 4 T1/E1 WAN ports and Redundant AC supplies, *Cobalt Blue* color

3092/24/R48: 24 Port ISDL DACS with 4 T1/E1 WAN ports and Redundant DC supplies, *Cobalt Blue* color

3092/24/U48: 24 Port ISDL DACS with 4 T1/E1 WAN ports and one AC and one DC supply, *Cobalt Blue* color

KiloModem™ 2B1Q Encoding, 2 or 4-wire Baseband Modem

Model 1092A

Make campus LAN and WAN connections using only two wires!

The Model 1092A KiloModem supports point-to-point, sync or async communication over either 2 or 4 twisted-pair (two wires). The Model 1092A is an excellent choice for high speed leased-line Internet links, LAN interconnection, or campus networks. The Model 1092A uses replaceable QuikConnect™ interface modules, which allow connection to a variety of interfaces. Local analog, remote digital loopback test modes, and V.52 BERT pattern generator are built into the Model 1092. Rack cards are also available.



FEATURES & BENEFITS

- ✓ Multiple full-duplex symmetric rates (32, 56, 64, or 128 kbps)—users select the bandwidth option they need
- ✓ Speeds to 128 kbps
- ✓ Distances up to 10 miles (17 km)
- ✓ Standalone (QuikConnect) and rackmount versions
- ✓ SNMP network management—including in-band management of remote units, plus advanced diagnostics and statistics.
- ✓ Front panel status indicators
- ✓ Transparent to DLCs broad compatibility
- ✓ Long-reach IDSL

ORDERING INFORMATION

Base units

1092A/A/UI: IDSL Standalone, V.24

1092A/B/UI: IDSL Standalone, RS-422

1092A/C/UI: IDSL Standalone, V.35

1092A/D/UI: IDSL Standalone, X.215

1092A/F/UI: IDSL Standalone, 64Kbps G.703

1092A/I/UI: IDSL Standalone, Ethernet

1092A/14/UI: IDSL Standalone, 4 port hub

1092A/J0/UI: IDSL Standalone, FXO Voice/Data module

1092A/JS/UI: IDSL Standalone, FXS Voice/Data module

1092A/UI: IDSL Standalone

Rack cards

1092ARC/A/B: IDSL Rack Card, V.24

1092ARC/A/I: IDSL Rack Card, V.35

1092ARC/B/B: IDSL Rack Card, RS-530

1092ARC/C/IA: IDSL Rack Card, Ethernet

1092ARC/C/O: IDSL Rack Card, 64Kbps G.703

1092ARC/D/V: IDSL Rack Card, X.21

Note: Model 1092 rack cards plug into the Model 1001 rack system (see page 132)

Typical application

Patton's Model 1092A supports both 2-wire and 4-wire operation. Standalone units can be used back-to-back or with the Model 1001 rack system for long-range point-to-point links. When used with the Model 3092, 64/128/144 kbps IDSL circuits can be concentrated on high speed egress ports.



Distances for 2-wire operation shown.
4-wire distances are better.

Data Rate (kbps)	Wire Gauge (AWG/mm)			
	19 (.9mm)	22 (.6mm)	24 (.5mm)	26 (.4mm)
128	10.8 (17.4)	7.2 (11.6)	5.0 (8.1)	3.4 (5.5)
64	10.8 (17.4)	7.2 (11.6)	5.0 (8.1)	3.4 (5.5)
56	10.8 (17.4)	7.2 (11.6)	5.0 (8.1)	3.4 (5.5)
32	10.8 (17.4)	7.2 (11.6)	5.0 (8.1)	3.4 (5.5)
0 - 38.4	10.8 (17.4)	7.2 (11.6)	5.0 (8.1)	3.4 (5.5)

SPECIFICATIONS

Transmission Format: Synchronous
Clocking: Internal, external or receive recover
RTS/CTS Delay: no delay, 4–8 ms, or 33–58 ms

LED Status Indicators: TD, RD, CTS, CD, DTR, NS (no signal), ER (error), and TM (test mode)
Isolation: 1500V RMS
DTE Interface: V.24/RS-232, V.35, X.21, G.703, Data+Voice and Ethernet Bridge interface modules

Diagnostics: LAL, RDL, V.52 compliant BERT pattern (511/511E pattern) generator and detector
Power: 100–240 VAC, 50/60 Hz (universal input); 48 VDC (option). 5 watts

IDSL Modems with V.35, X.21, or 10Base-T (Ethernet) Interfaces

Model 1082

The 1082 Series are high speed, AC powered short-range modems that are able to operate synchronously or asynchronously—full duplex—over a single twisted-pair.

The Model 1082 supports data rates to 128 kbps (synchronous) or 38.4 kbps (asynchronous). It is capable of point-to-point distances up to 5 miles (8 km) using 24 AWG wire.

The Model 1082 Series supports internal, external, or receive loopback clocking in synchronous mode. Data rates and asynchronous data format may be configured locally using DIP switches.

Model 1082/C provides a V.35 interface on an M/34 female connector. Model 1082/D is configured with an X.21 interface on a DB-15 female connector.



Line connection is made by an RJ-45 jack. Standard versions of the Model 1082 Series are powered by a 100–240 VAC (universal) supply. The DC power supply option supports any DC input between 36–72 VDC.

FEATURES & BENEFITS

- ✓ Synchronous data rates: 19.2, 32, 56, 64, 128 & 144 kbps (1082/144 models); Asynchronous data rates: 0–38.4 kbps
- ✓ Full-duplex operation over a single twisted pair (2-wires)
- ✓ Point-to-point distances up to 5 miles (8 km) (all data rates) on 24 AWG twisted pair
- ✓ Internal, external, or receive recovered clocking options (Model 1082/1 only)
- ✓ LED indicators for TM, ER, NS, DSL (Models 1082 C & D), 10Base-T (Model 1082/1), and Status (Model 1082/1)
- ✓ V.35 and X.21 interfaces (Models 1082 C & D); Ethernet Interface (Model 1082/1)
- ✓ Multi-rate symmetric DSL
- ✓ Interoperable with popular Patton Models 3092 and 1092A
- ✓ SNMP manageable with 3092 or a 1092ARC in a 1001 Rack equipped with a 1001MC SNMP agent rack card

Typical applications

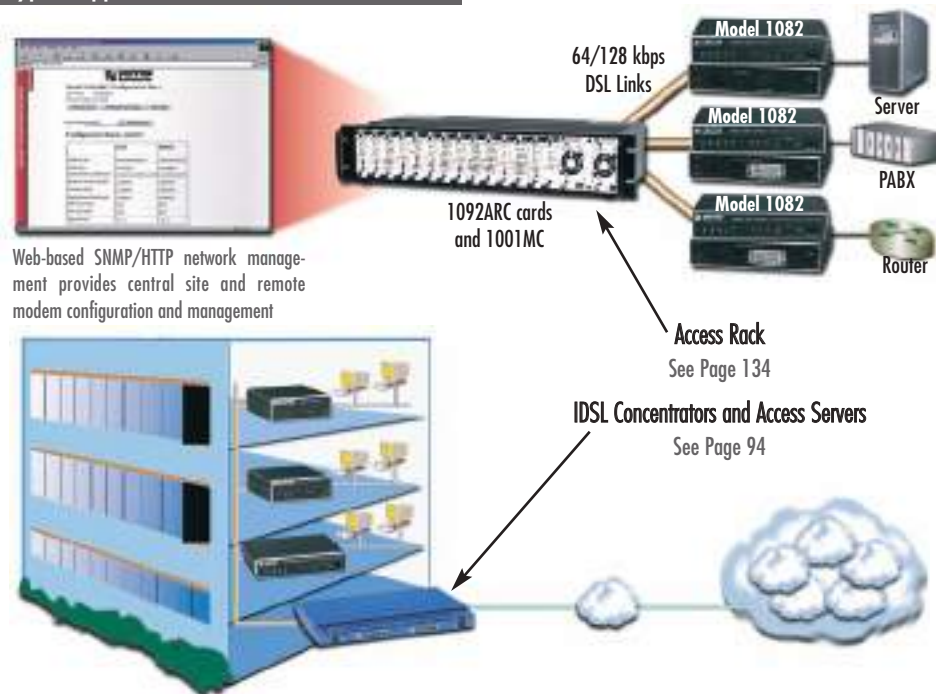

ORDERING INFORMATION

- 1082/C/48:** IDSL modem; V.35 interface & -48 VDC power
- 1082/C/UI:** IDSL modem; V.35 interface & 100–253 VAC power
- 1082/D/48:** IDSL modem; X.21 interface & -48 VDC power
- 1082/D/UI:** IDSL modem; X.21 interface & 100–253 VAC power
- 1082/F/48:** IDSL modem; 64/128k G.703 interface & -48 VDC power
- 1082/F/UI:** IDSL modem; 64/128k G.703 & 100–253 VAC power
- 1082/I/48:** IDSL modem; Ethernet interface & -48 VDC power
- 1082/I/UI:** IDSL modem; Ethernet interface & 100–253 VAC power

SPECIFICATIONS

Transmission Format: Synchronous or asynchronous

Transmission Line: Single unconditioned twisted pair

Clocking: Internal, external or receive loopback

Distance: Distance, max. all data rates-10.1 miles (16.4km) on 19 AWG (0.9mm) wire; 7.2 miles (11.5 km) on 22 AWG (0.64mm) wire; 5.0 (8 km) on 24 AWG (0.5mm) wire; 3.4 (5.5 km) on 26 AWG (0.4mm) wire

Data Rates: Synchronous 19.2, 32, 56, 64 & 128 kbps; Asynchronous 0–38.4 kbps

Connectors: RJ-45 on line side; RJ-45, M/34 female or DB-15 female on serial interface side.

Diagnostics: V.52 compliant bit error rate pattern (511/511E pattern) generator and detector with error injection mode; Local Line Loopback and Remote Digital Loopback, activated by front panel switch or via serial interface

Power: 100–253 VAC, 50–60 Hz (universal input option); 48 VDC (option), 5 watts.

Temperature Range: 32–122°F (0–50°C)

Humidity: 5–95% non-condensing

Dimensions: 4.7 x 1.52 x 5.0 in. (18.5 x 16.8 x 4.1 cm)

Weight: 0.58 lbs.

Line Interface: Transformer coupled 1500 VAC isolation

High-Speed Serial Extender & RS-232 Serial Extender

Models 1053AF & 1052AF

These miniature high-speed digital modems offer multi-rate Async/Sync while transparently passing modem control signals. Both 2-wire full-duplex modems uses 2B1Q modulation for superior noise immunity.



The 1053AF and 1052AF are long-range, powered, digital modems that operate synchronously or asynchronously at full duplex over a single twisted pair. The 1053AF operates at multi-rate async/sync speeds up to 115.2/128 kbps; the 1052AF at speeds up to 38.4/128 kbps. Both modems utilize 2B1Q modulation for superior signal strength, even in the noisiest environments. RS-232 serial connections with

speeds of 128 kbps can now be extended to distances over 5 miles (8 km) without the use of repeaters! Using ordinary voice-grade wire, the serial extenders provide a cost-effective solution for high speed, dedicated, end-to-end connections with synchronous line rates up to 128 kbps and asynchronous line rates up to 115.2 kbps (1053AF) or 38.4 kbps (1052AF) that include RTS, CTS and DCD modem signals.

The modems' miniature size allow for a direct connection to your transmission device's serial port. Two 8-position DIP switches enable configuration of asynchronous or synchronous line rate settings. Additionally, LEDs are conveniently located on the side of the modems to provide at-a-glance status indication of the unit.

FEATURES & BENEFITS

- ✓ Multi-Rate Speeds — **1053AF:** Full-duplex synchronous rates to 128 kbps and asynchronous rates to 115.2 kbps
1052AF: Full-duplex synchronous rates to 128 kbps and asynchronous rates to 38.4 kbps.
- ✓ Extends serial devices up to 5 miles (8 km) over ordinary grade twisted pair
- ✓ Noise Immunity — Uses 2B1Q for improved performance in noisy environments.
- ✓ Pass RS-232 Control Signals — Transparently passes CTS, RTS, and DCD over the 2-wire line.
- ✓ Miniature size for direct connections to your serial port
- ✓ Long Reach — Industry leading distances of over 26,000 feet (8 km) without repeaters.
- ✓ Power Options — Universal AC power (90–260 VAC) as well as -12, -24, & -48 VDC.

Application diagram

The Model 1053AF and Model 1052AF offer premium performance using the most common, inexpensive cabling infrastructure in the world, voice-grade telephone wire. Using 2B1Q modulation a serial port can be extended to distances of over 5 miles (8 km).



SPECIFICATIONS

Clocking: Internal, external, or receive recover.

Line Coding: 2B1Q conforming to ANSI T1.601 and ETSI ETR-080 standards.

Line Interface: RJ-45; Two-wire twisted-pair using pins 4 & 5; Transformer coupled 1500 VRMS isolation

Maximum Line Distance for All Data Rates: 10.1 miles (16.4 km) on 19 AWG (0.9 mm) wire • 7.2 miles (11.5 km) on 22 AWG (0.64 mm) wire • 5.0 (8 km) on 24 AWG (0.5 mm) wire • 3.4 (5.5 km) on 26 AWG (0.4 mm) wire

Serial Interface: DB-25 Female or DB-9 Female depending on model ordered.

Serial Data Rates:
1083AF: Synchronous: 2, 56, 64, and 128 kbps • Asynchronous: 38.4, 57.6, 76.8, and 115.2 kbps
1052AF: Synchronous: 32, 56, 64, and 128 kbps • Asynchronous: 0–38.4 kbps.

LED Indicators: TXD, RXD, Link, NS (no signal), ER (CRC error)

Power Supplies: External wall-mount power supply with universal 90–260 VAC input or -12, -24, and -48 VDC input

Dimensions: 5.18L x 1.69W x 0.75H in. (13.16L x 4.29W x 1.91H cm)

Weight: 2.01 lbs. (<1.0 kg)

Compliance: EMC: FCC Part 15, sub-part B, class A (US) • EMC Directive 89/336/EEC (EU) • ICES-003 (Canada) • AZ/NZS 3548 (Australia C-Tick) • CISPR 22 (International)

Safety: UL 60950/CAN-ISA-C22.2 60950 (Safety—US/Canada) • EN 60950 (Safety—Europe/International)

Operating temp.: 32–122°F (0–50°C)

Humidity: 5–95% non-condensing
Altitude: 0–15,000 feet (0–4,572 meters)

I'm John, one of Patton's Marketing Group Managers. If you do not find what you need at www.patton.com or in this catalog, please call me at +1 301.975.1000, x160. You can also send e-mail to jgrant@patton.com.



visit us online
www.patton.com

FAST Delivery From Your AUTHORIZED DISTRIBUTOR!



ORDERING INFORMATION

1052/AF/UI: Async 38.4/Sync 128 kbps RS-232 Extender
1053/AF/UI: Async 115.2/Sync 128 kbps RS-232 Extender

Network Termination

T1/E1, EVFE1 CSU/DSU Products

For T1/E1 network termination, Patton's products offer flexible access and connectivity for less!

- ✓ Patton products come in a variety of packages and satisfy any requirement—from miniature, full-featured units to desktop and rack card solutions.
- ✓ Whether you need to connect to X.21, V.35, EIA-530, or Ethernet—Patton has the DTE interface solution.
- ✓ Patton T1/E1 products connect your router, multiplexer, or PBX to a variety of voice or data services: from leased-line Point-to-Point, to Frame Relay, to Internet access, all products connect at full or fractional speeds.

Domestic Series T1-Based Solutions

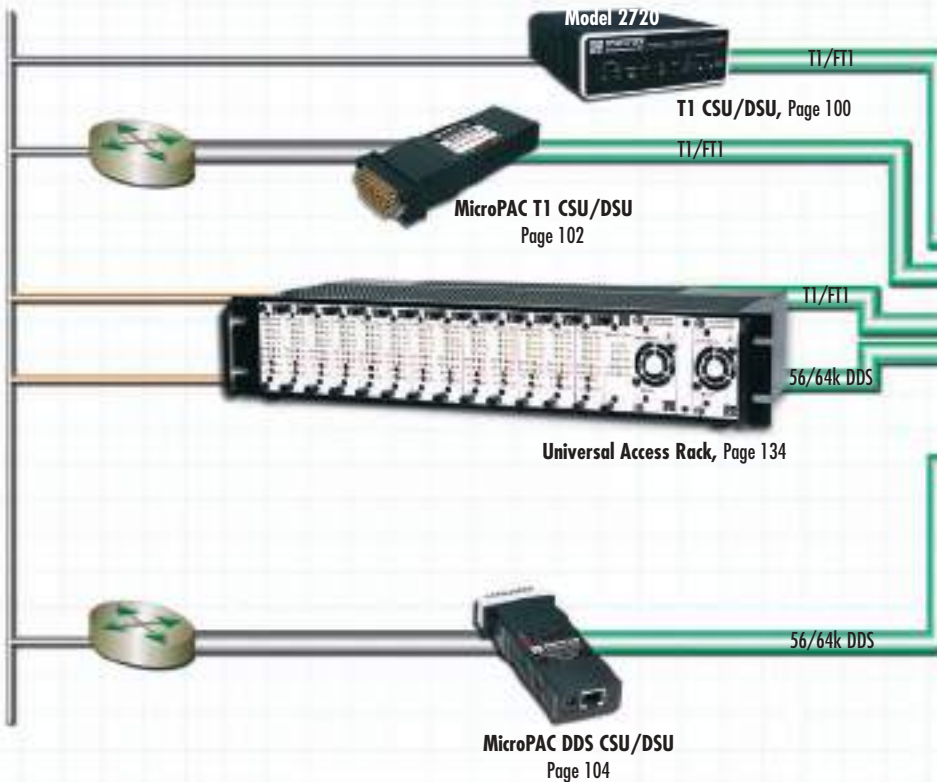

TERMINATING STANDARD SERVICES

- ✓ Private Leased Lines
- ✓ Frame Relay/ATM
- ✓ IP/Ethernet delivery

This router supports
T1 and E1



Model 2603 T1/E1, Drop & Insert Router

Both T1 and E1 CSU/DSU with full IP Routing.

Patton's new T1/E1 IPLink™ Router is a low cost and robust enterprise routing device for the global economy. This one router can be used anywhere in the world because it supports T1 and E1, as well as IP, Frame Relay, and ATM routing services.

Page 48

Access Without Excess

Patton's EtherRocket for T1/E1 IP Services.

Equipped with a 10Base-T Ethernet front-end and a T1 or E1 interface, the EtherRocket with Remote Router Porting (RRP) seamlessly connects your LAN to an Internet service provider (ISP) or connects a branch office to headquarters via point-to-point leased-lines. All without a router at the customer premises.

International Series E1-Based Solutions

ACCESS CONVERSION

- ✓ Mega-Stream & Kilo-Stream
- ✓ ISDN/PBX
- ✓ IP

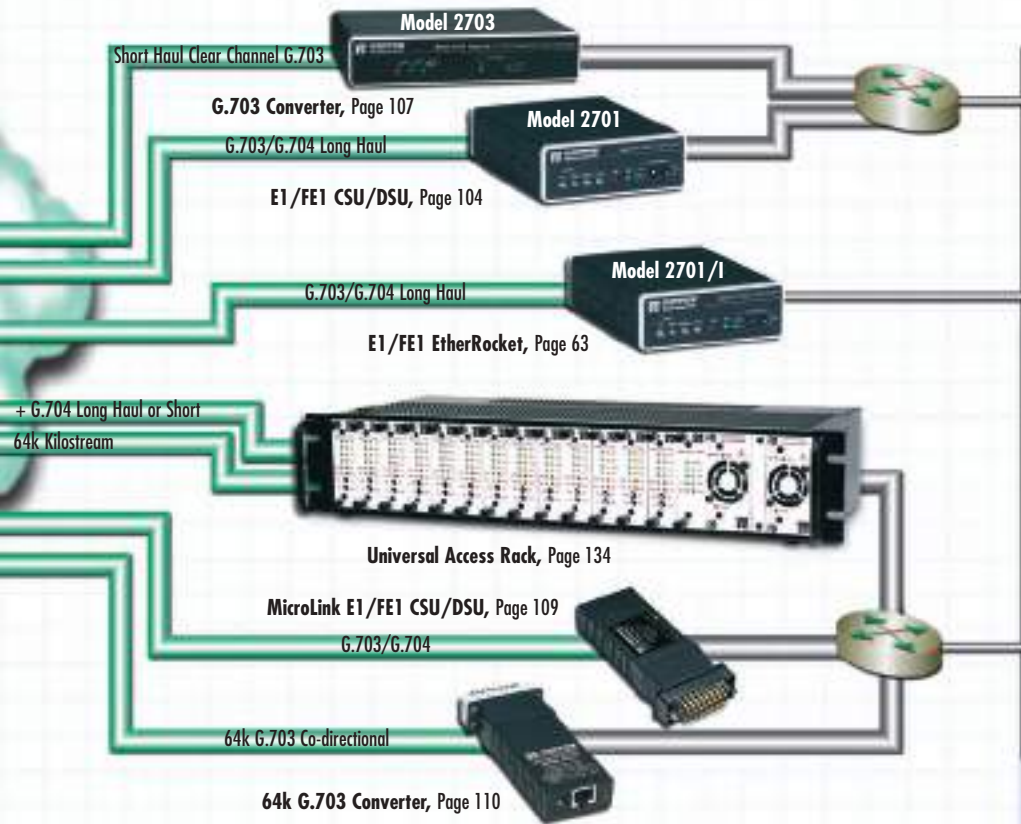

In This Section

T1 Network Access	100
Compact T1/FT1 CSU/DSU	100
T1/FT1 to V.35 Converter & CSU/DSU	102
T1/FT1 High-Density, CSU/DSU Rack Card	103
E1/G.703 Access Converters	104
MicroLink™ CSU/DSU	104
G.703/G.704 NTU	104
MicroPak™ G.703 Interface Converter	106
MegaLink-IT™ 2 Mbps G.703 Access Converter	107
64-K G.703 Access Converters	108
Lowest Cost G.703 NTU	108
MicroLink-E1™ E1/FE1 Nx64 CSU/DSU	109
Co-directional G.703 Converters	110
G.703/64-kbps Interface Converter	111

Multi-Megabit Inverse Mux

Patton's IPLink™ Model 2888 facilitates the bonding of up to 4 T1/E1 ports into a high-bandwidth WAN link to feed the most bandwidth hungry applications.



Compact, T1/FT1, High Density, Low Cost CSU/DSU

Model 2720

New CSU/DSU makes it simple and affordable to connect to T1/Fractional T1 services.

The NetLink Model 2720 Series T1/FT1 CSU/DSU provides high speed WAN connectivity in a compact full-featured standalone package.

The NetLink 2720 is an excellent choice for terminating leased lines, Frame Relay backbones, Internet access, and LAN-to-LAN services. When terminating a T1-dedicated digital circuit, the NetLink 2720 supports nx56/nx64 kbps T1 framing and converts to V.35, RS-530, or 10Base-T Ethernet interfaces.

The NetLink 2720 supports D4/ESF framing options and AMI/B8ZS/B7ZS line coding. Data rates, framing, and coding options are programmed by DIP switches or from a VT-100 terminal with menu-driven software. A full range of system and diagnostic features make setup simple and easy.

The Model 2720/1 (10 Base-T Ethernet Bridge) is particularly suited for LAN-to-LAN connection without the need for routers! MAC forwarding and PPP/BCP built-in bridging provides seamless connection over the T1 link.



The PPP/BCP features also enable customers to extend a router's serial interface and connect to a remote Ethernet LAN over the T1 network.

The 2710RC is the rack card companion to the Model 2720. Offering all features found in the 2720, the 2710RC fits in a 19-inch, 2U high rack housing up to 16 rack cards.



FEATURES & BENEFITS

- ✓ Terminates T1/FT1 circuits over a 4-wire RJ-48C interface
- ✓ 100–240VAC and -48VDC power options
- ✓ Connects to V.35, EIA-530, and Ethernet interfaces
- ✓ Ethernet version for LAN to LAN Bridging
- ✓ Common framed n x 56/64 kbps rates up to 1.536 Mbps
- ✓ Unstructured rates at 1.544 Mbps
- ✓ D4 or ESF framing modes
- ✓ Supports AMI or B8ZS/B7ZS line coding
- ✓ Software or DIP switch configurable
- ✓ Internal, external, or network clocking
- ✓ V.54, V.52, and CO Loop and Loop down diagnostics
- ✓ Available in Rackmount version (Model 2710RC)
- ✓ Also functions as a high speed point-to-point modem
- ✓ Made in USA



See Pg 134

Connecting a branch office to headquarters using the 2720/1 "EtherRocket" and remote router porting

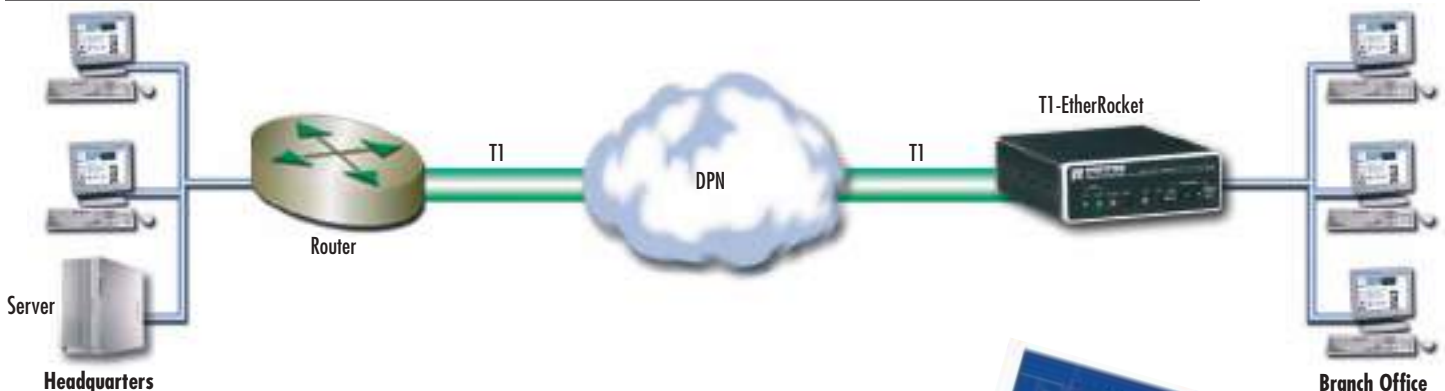

Download our free "Remote Router Porting with T1" position paper and learn how to use the EtherRocket to connect small or branch offices without the cost and headache of a remote router. Go to www.patton.com/support/library.shtml for your free copy.



Software management

In addition to DIP switch configuration, the Models 2720 and 2710RC can be easily configured, tested, and monitored via intuitive software menus. The Model 2720 includes an RS-232 port and cable for connection to a PC or terminal. Simply start a terminal program in your PC (Hyperterminal, for example) to gain access to a complete set of configuration parameters and diagnostics. Access to configuration menus in the Model 2710RC requires the use of a Patton 1001CC module card installed in the rack. A 1001CC card can access up to 15 2710RC modems per rack.

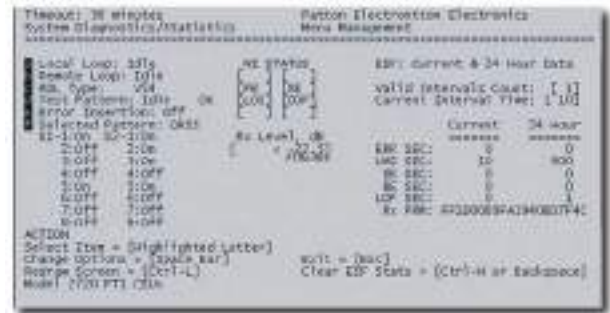

T1 network termination on V.35 or EIA-530 for data



The Models 2720 and 2710RC T1 CSU/DSUs come with V.35 or EIA-530 for simple connection to routers or multiplexers at the customer or service provider premises. The 2720 and 2710RC

connects easily to your router and T1 line and provides termination to fractional or full T1 services. The CSU/DSUs work in D4 or ESF T1 framing modes, and are transparent to any WAN

protocol originating at the local router such as ATM/FR/PPP or voice services.

LAN-to-LAN without a router



In the most common installations of WAN Ethernet bridging, two LAN segments are connected with a common WAN interface such as T1. Each T1 EtherRocket connects to the local

Ethernet LAN and builds a table of local hosts on that network. If an Ethernet message is not for a local host, the EtherRocket forwards it over the WAN to the remote EtherRocket. User on

a LAN segment can access hosts and applications at the far end LAN as easily as if they were located on the local LAN.

SPECIFICATIONS

WAN Speed: 1.544 Mbps
WAN Connection: RJ-48C
Nominal Impedance: 100 Ohms
DTE Interface: EIA-530, V.35, 10Base-T Ethernet
Line Coding: AMI/B8ZS
Line Framing: D4/ESF/Unframed
Clock Options: Internal, external, or network
Diagnostics: Responds to CO-initiated D4 loop-up and loop-down codes, ESF line loop and payload loop FDL messages, and universal loopback de-activate messages

Transmit LBO: Selectable—0, 7.5, 15, or 22.5 dB, plus DSX-1
Standards: AT&T TR62411, TR54016, and ANSI T1.403
Dimensions: 0.78H x 2.1W x 3.5D in. (2.0H x 5.3W x 8.9D cm)
Test Modes: Initiates and responds to V.54 and CSU remote loops; local loop Pattern Generator/Detector; User selectable 511, 2047, or QRSS
Power: Universal input (100–240 VAC), or -48VDC

ORDERING INFORMATION

2720/B/UI: Standalone T1/FT1 CSU/DSU; EIA-530 Interface (DB-25F); 90–240 VAC supply
2720/C/UI: Standalone T1/FT1 CSU/DSU; V.35 (M/34F) Interface; 90–240 VAC supply
2720/I/UI: Standalone T1/FT1 CSU/DSU; 10Base-T (RJ-45) Interface; 90–240 VAC supply

2720/B/48: Standalone T1/FT1 CSU/DSU; EIA-530 (DB-25F) Interface; 48 VDC supply
2720/C/48: Standalone T1/FT1 CSU/DSU; V.35 (M/34F) Interface; 90–240 VAC supply
2720/I/48: Standalone T1/FT1 CSU/DSU; 10Base-T (RJ-45) Interface; 90–240 VAC supply

visit us online
www.patton.com

FAST Delivery From Your AUTHORIZED DISTRIBUTOR!



T1/FT1 to V.35 Interface Converter/CSU/DSU with Control Port

Model 2710

Pocket-sized converter-CSU/DSU makes it simple and affordable to connect V.35 to T1 or Fractional T1 (Nx64).

The Model 2710 T1-to-V.35 interface converter/CSU/DSU connects to a 4-wire T1 circuit and plugs directly into the V.35 interface of a router, switch or multiplexer.

Connecting to an unstructured T1 circuit at 1.544 Mbps, the Model 2710 also supports nx56/64 framed connections at data rates from 128 kbps to 1.536 Mbps. In addition, the Model 2710 may be used in pairs in point-to-point applications, where it is able to connect two V.35 devices at data rates to 1.544 Mbps over distances to 6,000 ft (1.14 miles/1.82 km).

The Model 2710 supports D4/AMI or B8ZS/ESF line coding and framing, internal or network clocking, and selectable 0, 7.5, or 22.5 dB line build-out (LBO) levels. These parameters are user configurable via internal DIP switch settings, or through software commands using the Model 2710's RS-232 control port. The Model 2710 is also config-



urable for clear channel (1.544 Mbps) or fractional (nx56/64 kbps) operation. Fractional settings include 2, 4, 6, 8, 12, 16, and 24 channels (for example, setting the Patton 2710 at 224/256 kbps would activate four 56/64 kbps channels).

Power is supplied to the Model 2710 through an external AC power supply.

FEATURES & BENEFITS

- ✓ Plugs directly into V.35 interface of router, switch or multiplexer
- ✓ Connects to an unstructured 4-wire T1 circuit at 1.544 Mbps
- ✓ Supports n x 56/64 framed T1 connections from 64 kbps to 1.536 Mbps
- ✓ Data rates, clocking and LBO levels selected by internal DIP switches or via an RS-232 software control port
- ✓ Facilitates point-to-point campus communication up to 6,000 ft (1.14 miles/1.82 km) when used in pairs
- ✓ Supports D4/AMI or B8ZS/ESF line coding, loopback diagnostics
- ✓ Seven easy-to-read diagnostic LEDs

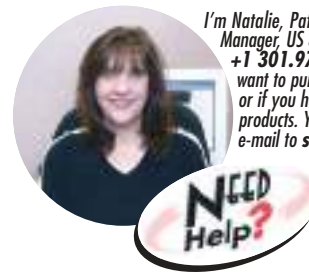

I'm Natalie, Patton's Inside Sales Manager, US & Canada. Call me at +1 301.975.1000 when you want to purchase Patton products or if you have questions about our products. You can also send e-mail to sales@patton.com.

Application diagram

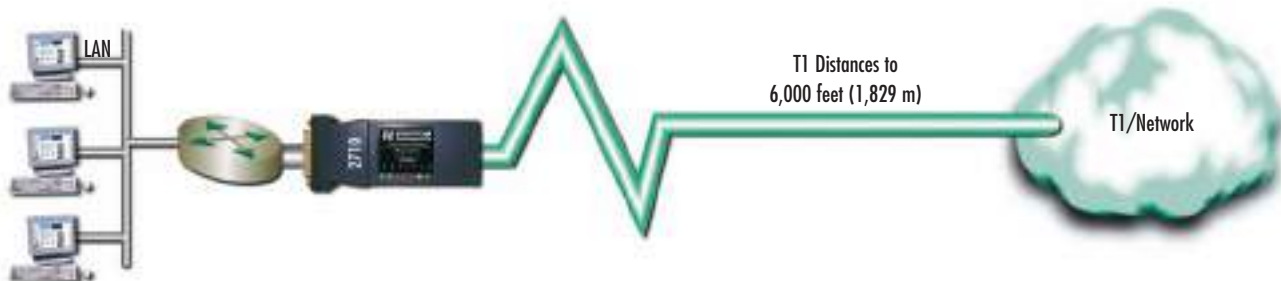

SPECIFICATIONS

Transmission Format: Synchronous, 4-wire

Network Connection: RJ-48C

Nominal Impedance: 100 ohms

Network Line Speed: 1.544 Mbps

Distance: Up to 6,000 feet, point-to-point (when used in pairs)

DTE Data Rates: Switch selectable nx56/64, 128 kbps–1.536 Mbps

DTE Interface: Integral V.35 (M/34 male) connector

Line Coding/Framing: AMI/B8ZS or D4/ESF

Transmit LBO: Selectable—0, 7.5, or 22.5 dB

Receive LBO: Automatic

Clocking: Internal or Network
LED Status Indicators: TXD, RXD, LOS (loss of signal), ALM (alarm), ERR (error), TST (test), PWR

Power: External AC power supply
Diagnostics: Responds to CD initiated D4 loopup and loopdown codes, ESF line loop and payload loop FDL messages, universal loopback de-activate message

Compliance: CE Marked per EMC Directive 89/336/EEC and Low Voltage Directive 73/23/EEC; FCC Part 15, Class A; Canadian DOC CS 03

Standards: AT&T TR62411, ANSI T1.403, TR54016

Dimensions: 5.0 L x 2.1W x 0.81D in. (12.7L x 5.3W x 2.1D cm)
Weight: 2.02 lbs. (0.92 kg)

ORDERING INFORMATION

2710/CM/UJ: T1/FT1 Nx64 with control port (V.35, M/34 male, 100–240 VAC)

2710/CM/-48: T1/FT1 Nx64 with control port (V.35, M/34 male, 48 VDC)

Note: Adapter cables are available for connecting the Model 2710 to WAN equipment that does not use a standard V.35 interface (such as the Cisco 2501 router, which uses a high density 60-pin connector).

T1/FT1 High-Density, Low Cost CSU/DSU Rack Card

Model 2710RC

T1/Fractional-T1 CSU/DSU rack card connects to a space-saving, SNMP-manageable platform.

The NetLink-T1 Model 2710RC Series are T1/FT1 CSU/DSUs that provide high speed WAN connectivity in a rack card package. Patton's 2U (8.9-cm) redundant AC/DC rack chassis accepts up to 16 rack cards, saving valuable space in central site locations.

NetLink 2710RC is an excellent choice for terminating leased lines, Frame Relay backbones, Internet access, and LAN-to-LAN services. When terminating a T1-dedicated digital circuit, the NetLink 2710RC supports nx56 kbps and nx64 kbps framing for T1 and V.35, X.21, RS-530, or 10Base-T Ethernet interfaces.

The NetLink 2710RC supports D4/ESF framing options and AMI/B8ZS/B7ZS line coding. Data rates, framing, and coding options are programmed by DIP switches or from a VT-100 terminal with menu-driven software. The NetLink



2710RC also supports SNMP management from a NetLink Model 1001MC SNMP/HTTP rack card. A full range of system and diagnostic features make setup simple and easy.

FEATURES & BENEFITS

- ✓ Terminates T1/FT1 circuits over a 4-wire RJ-48C interface
- ✓ Connects to standard CPE serial and Ethernet interfaces
- ✓ Common framed n x 56/64 kbps rates up to 1.536 Mbps
- ✓ Unstructured rates at 1.544 Mbps
- ✓ D4 or ESF framing modes
- ✓ Supports AMI or B8ZS/B7ZS line coding
- ✓ Software or DIP switch configurable
- ✓ Internal, external, or receive recover clocking
- ✓ Also functions as a high speed point-to-point modem
- ✓ Compatible with desktop models 2710 and 2720
- ✓ Made in USA



T1 termination application



I'm Brian, one of Patton's Product Validation Engineers who makes sure your network termination product works reliably. To buy one of these state-of-the-art devices, call +1 301.975.1000 or send e-mail to sales@patton.com.

SPECIFICATIONS

WAN Speed: 1.544 Mbps
WAN Connection: RJ-48C
Nominal Impedance: 100 Ohms
DTE Interface: EIA-530, V.35, X.21, Ethernet
Line Coding: AMI/B8ZS
Line Framing: D4/ESF/Unframed
Clock Options: Internal, external, or network
Diagnostics: Responds to CO-initiated D4 loop-up and loop-down codes, ESF line loop and payload loop FDL messages,

and Universal Loopback de-activate messages
Transmit LBO: Selectable—0, 7.5, 15, or 22.5 dB, plus DSX-1
Standards: AT&T TR62411, TR54016, and ANSI T1.403
Test Modes: Initiates and responds to V.54 and CSU remote loops; local loop
Pattern Generator/Detector: User selectable 511, 2047, or QRSS
Dimensions: 0.78H x 2.1W x 3.5D in. (2.0H x 5.3W x 8.9D cm)

ORDERING INFORMATION

- 2710RC/B/B:** Powered T1/FT1 CSU/DSU Card; EIA-530 Interface
- 2710RC/A/I:** Powered T1/FT1 CSU/DSU Card; V.35 Interface
- 2710RC/D/V:** Powered T1/FT1 CSU/DSU Card; X.21 Interface
- 2710RC/I/A:** Powered T1/FT1 CSU/DSU Card; 10Base-T Interface

visit us online
www.patton.com

FAST Delivery From Your AUTHORIZED DISTRIBUTOR!



MicroLink™ CSU/DSU

Model 2400

Tiny 56/64 kbps CSU/DSU fits into the tightest spaces!

The Model 2400 MicroLink™ supports 64 kbps Clear Channel™ and 56 kbps DDS sync communication over two twisted-pair wires.

Available with either an M/34 (V.35) or DB-25 (RS-232) connector, the Model 2400 plugs directly into your DTE port. Clocking can be set for internal, external, or receive recover (network). Diagnostics include CSU loop and V.54 (respond) loop.

SPECIFICATIONS

DDS Type: Dedicated, 56 or 64 kbps

Transmission Format:

Synchronous

DTE Interface: RS-232 or V.35

Transmission Line: 4-wire, RJ-48S

Standards: AT&T 62310 compliant

Indicators: ER (error) and TM (test mode)

Max Distance: 3.4 mi. (5.4 km) on 26 AWG (0.4mm)

Connectors: DB-25 (RS-232) or M/34 (V.35)

Clocking: Internal (master), external (slave), receive recover (network), campus

Power Supply: External AC adapter

Diagnostics: V.54 loop (respond only), CSU loop

Dimensions: 3.55 x 2.1 x .78 in. (9.0 x 5.3 x 1.9 cm) RS-232 version



FEATURES & BENEFITS

- ✓ Plugs directly into a router—just like an adapter cable!
- ✓ Operates over 56 kbps DDS, 64 kbps Clear Channel™, or private
- ✓ Your choice of V.35 (M/34) or RS-232 (DB-25) versions
- ✓ Selectable clocking: Internal (Master), External (DTE), or Receive Recover (Network)

ORDERING INFORMATION

2400/AM/120: MicroLink (RS-232, DB-25 male, 120 VAC power)

2400/AF/120: MicroLink (RS-232, DB-25 female, 120 VAC power)

2400/CM/120: MicroLink (V.35, M/34 male, 120 VAC power)

G.703/G.704 Network Termination Unit (NTU)

Models 2701 & 2701RC

These devices, available in low-cost standalone or rack-mountable versions, terminate G.703/G.704 lines and provide E1/Fractional-E1.



One of the smallest and most economical NTUs available, the Model 2701 is designed with features usually found in more expensive units: flexible clocking modes, AMI/HDB3 coding, V.52/V.54 diagnostics, and user-selectable nx64 kbps data rates.

The NTUs terminate G.703/G.704 services for all nx64 kbps rates and connect to the customer's router, FRAD, CODEC, and switches with a V.35, X.21, EIA-530, or 10Base-T Ethernet interface.

The Model 2701 series terminates E1/FE1 services for all nx64 kbps to 2.048 Mbps rates and connects to a router, FRAD, CODEC, or LAN with V.35, X.21, EIA-530, or 10Base-T interfaces. Front panel LEDs and switches allow for instant diagnostics and service monitoring. Convenient DIP switches support quick and concise configuration of your E1 termination. AC or DC power options make installing the Model 2701 into your network infrastructure a snap.

Today's customers require low-cost network solutions that deliver high speed connections to the Internet and corporate intranets while supporting video-conferencing and many other wide-area services. The NetLink Models 2701 and 2701RC E1/Fractional E1 NTUs satisfy those needs.



FEATURES & BENEFITS

- ✓ Terminates E1/Fractional-E1 service
- ✓ nx64 kbps data rates to 2 Mbps
- ✓ X.21, V.35, EIA-530, and Ethernet bridge options
- ✓ Switch-selectable AMI or HDB3 line encoding options
- ✓ Switch-selectable DTE/DCE modes for X.21 version
- ✓ 75-ohm dual coax and 120-ohm twisted-pair G.703 connections
- ✓ Local and remote loopback diagnostics
- ✓ Internal, external and G.703 network timing
- ✓ Conforms to ONP requirements CTR 12 and CTR 13 for connection to international Telecom networks

Model 2701R version is also available in a rugged metal case for easy closet mounting



Models 2701 & 2701RC application: Connecting branch office to headquarters with 2701/I EtherRocket and remote router porting



Models 2701 & 2701RC application: E1 network termination on X.21 or V.35 for data



The Model 2701/D (X.21 version) provides DTE/DCE functionality in the same standalone or rack-mount package. This added versatility supports operation in X.21 DTE applications (see diagram above) where an NTU is needed to terminate G.703/G.704 and provide X.21/V.11 data to a multiplexer.

The diagram below shows how two Patton E1-EtherRockets can be used to link two Ethernet LANs over an E1/FE1 link. Each E1 EtherRocket connects to the local Ethernet LAN and build a table of local hosts on that network. If an Ethernet message is not for a local host, the bridge forwards it over the WAN to the remote

bridge. In this configuration, a user in one of the LAN segments is able to access any host and any application at the far end LAN, as easy as a local LAN connection.

Models 2701 & 2701RC application: LAN-to-LAN over E1 without a router

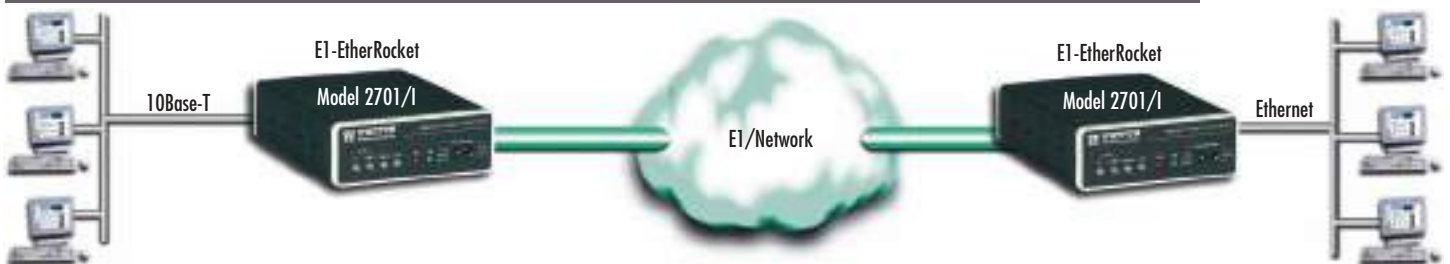

Check it out...No routers!

SPECIFICATIONS

Data Rate: Smooth clock 2.048 Mbps
Network Connector: RJ-48C (all versions); Dual coaxial (X.21 and Ethernet)
DTE Interface: EIA-530, X.21/V.11, V.35, or 10Base-T Ethernet
Line Coding: AMI or HDB3
Line Framing: G.703 (unframed) or G.704/G.732 (framed)
Clocking: Internal, external or receive recover
DTE Rates: nx64kbps (EIA-530, X.21/V.11, V.35); 10Mbps (10Base-T)
Indicators: E1 Link Status, TD, RD, Loss of Sync, Error, Test Mode, Ethernet Status (on 10Base-T Version)
Diagnostics: Local/remote loop, 511 Line Isolation: 1500 VRMS
Compliance: CE Mark, G.703, G.704, G.723, G.832, CTR-12 and CTR-13
Temperature: 32–122°F (0–50°C)
Rel. Humidity: 5–90% non-condensing
Dimensions:
Standalone unit
 5.84L x 4.16W x 1.51H in.
 (14.84L x 10.6W x 3.84H cm)
Rack card
 3.0H x 0.83W x 7.84D in.
 (7.6H x 2.1W x 19.0D cm)
Weight:
 Standalone unit: 2.225 lbs (1.02 kg)
 Rack card: 0.31 lbs (0.14 kg)

ORDERING INFORMATION

Standalone NTU, Universal 100–240 VAC Supply

- 2701/B/UI: EIA-530 (DB-25F) interface
- 2701/C/UI: V.35 (M/34F) interface
- 2701/D/UI: X.21 (DB-15F) interface
- 2701/I/UI: 10Base-T (RJ-45F) interface

Standalone NTU, -48 VDC Supply

- 2701/C/48: V.35 (M/34F) interface
- 2701/D/48: X.21 (DB-15F) interface
- 2701/I/48: 10Base-T (RJ-45F) interface

Rack card NTU

- 2701RC/A/I: RJ-45 line and V.35 (M/34F) DTE interfaces
- 2701RC/B/B: RJ-45 line and RS530 (DB-25F) DTE interfaces
- 2701RC/D/D: Dual BNC line and X.21 (DB-15F) DTE interfaces
- 2701RC/D/V: RJ-45 line and X.21 (DB-15F) DTE interfaces
- 2701RC/C/IA: RJ-45 line and Ethernet/10Base-T (RJ-45F) interfaces

The Model 2701RC rack cards plug into the Model 1001 rack system (see page 110)

visit us online
www.patton.com

FAST Delivery From Your AUTHORIZED DISTRIBUTOR!



MicroPak™ G.703 Interface Converter

Model 2702

This MicroPak™ interface converter provides unstructured, clear-channel, 2-Mbps G.703 applications in a small package.

The Model 2702 fits into environments where high speed E1/G.703 services are being offered to customers with routers/FRADs and other networking devices. These G.703 interface converters convert signals from the unstructured, clear channel, synchronous line interface—delivered by the carrier—to a 2-Mbps digital interface required by the users' networking equipment.

To accomplish this, the Model 2702 presents a RJ-48C interface to the line and a V.35 interface to the customer's device. The V.35 interface is presented using a male M/34 connector. Line coding and clock options may be selected using internally accessible DIP switches.



If other interfaces are required, the user may select our Model 2703 converter which presents the following interfaces: X.21, RS422/530, V.36/RS449 and V.24/RS232. These interfaces are delivered through a standard interface cable which connects to the female DB-25 on one end and the desired interface on the other. If other DTE speeds are necessary, our Model 2094 connects Fractional E1 at nx64 speeds up to 2 Mbps.

FEATURES & BENEFITS

- ✓ Converts unframed 2-Mbps G.703 to synchronous V.35
- ✓ Integral V.35 (M/34) male connector (60-pin Cisco router adapter cable also available)
- ✓ V.54 compliant loopback diagnostics with built-in QRSS, 511 and 2047 test pattern generator
- ✓ Easy-to-read LEDs for TXD, RXD, ALM, LOS, TST, and ERR
- ✓ AMI or HDB3 line coding
- ✓ Configuration via DIP switches
- ✓ External 100–240 VAC power supply



I'm Scott, Patton's Vice President of Product Management. If you do not find the answers you need at www.patton.com, please call me at +1 (301) 975-1000 x166. You can also send e-mail to scott@patton.com.

Typical Model 2702 application



ORDERING INFORMATION

2702/CM/UI: Micro-Pak Version. Clear Channel E1 Access Converter (V.35, M/34 male)

SPECIFICATIONS

Network (line) connector: 8-position RJ-45 connector

Nominal impedance: 120-ohm; 75-ohm available with Model 460 Balun

Network (line) data rate: 2.048 Mbps in accordance with ITU-T G.703

DTE interface: Integral V.35 (M/34 male)

DTE rate: 2.048 Mbps

Line encoding: Selectable for AMI or HDB3

LED indicators: Transmit data (TXD), receive data (RXD), alarm (ALM), test mode (TST), loss of sync (LOS), error (ERR)

Line framing: G.703 clear channel

Clocking: Selectable internal or network (receive recover) clock

Diagnostics: V.54 complaint loopbacks; built-in QRSS, 511 and 2047 test pattern generator and detector with performance monitoring

Standards: Fully compliant with ITU-T G.703

Approvals: FCC Part 15, Class A; CE Mark per EMC Directive 89/336/EEC and Low Voltage Directive 73/23/EEC; Canadian DOC; BABT

Power supply: 100–240 VAC, 50/60 Hz universal input; -48 VDC optional (10 watts)

Dimensions: 9.0 x 5.3 x 1.9 cm (3.5 x 2.1 x 0.78 in.)

Weight: 0.11 kg (0.25 lb.)

Low-cost T1/E1 WAN Access Router

IPLink™ Model 2603 WAN Gateway Routers easily connect your IP/LAN to any T1/E1, X.21, or V.35 network interface with routed or bridged connections



See page 48

MegaLink-I™ 2 Mbps G.703 Access Converter

Model 2703

Convenient network terminator, interface converter, and rate adapter...All in one box!

The Model 2703 MegaLink-I™ performs several tasks: network termination unit (NTU), interface converter, and rate adapter.

As an NTU, the Model 2703 receives unstructured, synchronous 2.048 Mbps data from a G.703 network and sends it to a router, bridge, multiplexer or other device.

As an interface converter, the Model 2703 accepts 120-ohm twisted pair or 75-ohm dual coax network connections (both types of interfaces are provided). Then it converts the signals to EIA-530 (V.36/RS-422), V.35 or X.21 formats (switchable) on a UD-26 connector.

As a rate converter, the Model 2703 lets a lower bandwidth device—256 kbps, 512 kbps, or 1.024 Mbps—connect to



a 2.048-Mbps G.703 link. The Model 2703 supports internal, external or network (receive loop) clocking. A loopback test is built-in, and front panel LEDs monitor power, network, master clock and test loop. Several power supply options and convert-er cables are available, call for details.

FEATURES & BENEFITS

- ✓ Network data rate of 2.048 Mbps
- ✓ Four selectable DTE Data Rates
- ✓ Supports V.35, RS-530 (V.36/RS-422) or X.21 terminals
- ✓ 75-ohm and 120-ohm network terminations
- ✓ Internal, external or network (receive loop) clocking

Rack card

The Model 2703RC is a 2U (3.5-inch) high rack card version of the MegaLink-I™. Built around Patton's midplane architecture, the Model 2703RC combines a front function card with a choice of two rear interface cards (120 ohm with RS-530, or 75 ohm with X.21). The Model 2703RC fits in Patton's rack chassis or ClusterBoxes™. One AC or DC power supply card provides power to up to 16 Model 2703RC converters. The Model 2703RC incorporates all basic MegaLink-I™ features, except rate adaptation.



OEM Module

At the heart of the MegaLink-I™ is Patton's IM703 G.703/E1 interface module. The IM703 module provides both 75-ohm (dual-coax BNC) and 120-ohm (RJ-45 twisted pair) 2.048-Mbps network connections in one compact daughterboard. Patton's IM703 module is also available separately for OEM applications.

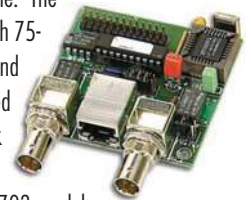

Local ISP with multiple G.703/E1 upstream links

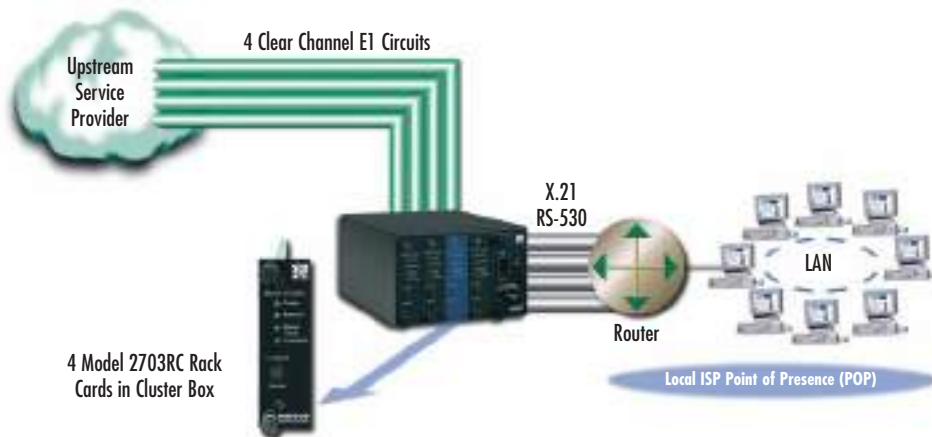

ORDERING INFORMATION

Universal interface version (UD-26)

2703/120: 120 VAC

2703/230: 230 VAC

2703/UI: 90–260 VAC

2703/DC: -48 VDC

X.21 only version (DB-15F)

2703-X.21/120: 120 VAC

2703-X.21/230: 230 VAC

2703-X.21/UI: 90–260 VAC

2703-X.21/DC: -48 VDC

Rack card

2703RC-A/A/45: V.35 (DB-25); RJ-48C

2703RC-A/A/CX: V.35 (DB-15); Dual Coax

2703RC-A/B/45: RS-422 (DB-25); RJ-48C

2703RC-A/B/CX: RS-422 (DB-25); Dual Coax

2703RC-A/C/45: X.21 (DB-15); RJ-48C

2703RC-A/C/CX: X.21 (DB-15); Dual Coax

SPECIFICATIONS

Network Interface: G.703

Network Rate: 2.048 Mbps

Network Connectors: Two BNC

(75 ohm) and one modular

RJ-45 connector (120 ohm)

Terminal Interface: RS-530

(V.36/RS-422), V.35 or X.21 on UD-26

(V.35 not available on rack cards)

Terminal Rate: 2.048 Mbps (all

models); 1.024 Mbps, 512 kbps, 256

kbps (standalone only)

Diagnostics: Loopback test

Indicators: LEDs for power, network, master clock and loop

Clocking: Internal, external, network (receive loop)

Receiver Sensitivity: -10 dB (0 dB = 2.4V)

Power: 120/240 VAC (switch selectable), 50/60 Hz; 100–240 VAC, 50/60 Hz (universal input option); 48 VDC (optional)

Dimensions: 7.3 x 6.6 x 1.62 in. (18.5 x 16.7 x 4.1 cm)

Lowest Cost G.703 Network Termination Unit (NTU)

Model 2707

This device terminates G.703 lines and provides serial and 10Base-T interface conversion.

Today's customers require low-cost network solutions that deliver high speed connections to the Internet and Corporate Intranets while supporting videoconferencing and many other wide-area services. The NetLink Model 2707 E1 NTUs satisfies those needs.

The NTUs terminate G.703 and connect to the customer's router, FRAD, CODEC, and switches with a V.35, X.21, or 10Base-T Ethernet interface.



FEATURES & BENEFITS

- ✓ Terminates E1 services
- ✓ Available in low-cost standalone or rack-mountable (2707RC) versions
- ✓ 2 Mbps data and line rate
- ✓ X.21, V.35, and Ethernet bridge options
- ✓ Switch-selectable AMI or HDB3 line encoding options
- ✓ Switch-selectable DTE/DCE modes for X.21 version
- ✓ 75-ohm dual coax and 120-ohm twisted-pair G.703 connections
- ✓ Local loopback diagnostics
- ✓ Internal, external and G.703 network timing
- ✓ CE approved
- ✓ UI (100–240 VAC) 120/230 VAC & 48 VDC power options
- ✓ Conforms to ONP requirements CTR 12 for connection to international telecom networks
- ✓ 1 mile (1.6 km) distance

E1 network on X.21 or V.35 for data



The Model 2707/D (X.21 version) provides DTE/DCE functionality in the same standalone or rack-mount package. This added versatility supports operation in X.21 DTE applications (see diagram above) where an NTU is needed to terminate G.703 and provide X.21/V.11 data to a multiplexer.

Our Ethernet version, the Model 2707/I offers 10Base-T bridging with PPP support. This enables customers to extend a router's serial interface and connect to a remote 10Base-T Ethernet LAN (see below). The 2707/I uses MAC learning and forwarding to provide seamless LAN-to-LAN connectivity.

SPECIFICATIONS

Data Rate: Smooth Clock 2.048 Mbps
Network Connector: RJ-48C (all versions); Dual Coaxial (X.21 and Ethernet)
Line Coding: AMI or HDB3
DTE Interface: X.21/V.11, V.35, or 10Base-T Ethernet
Line Framing: G.703 (unframed)
Clocking: Internal, External or Receive Recover

Diagnostics: Local Loop
Line Isolation: 1500VRMS
Compliance: CE Mark, G.703, and CTR-12
Op. Temp.: 32–122°F (0–50°C)
Humidity: 5–90% non-condensing
Dimensions: 5.84L x 4.16W x 1.51H in. (14.84L x 10.6W x 3.84H cm)
Weight: 2.225 lbs (1.02 kg)

E1 network on X.21 or V.35 for data

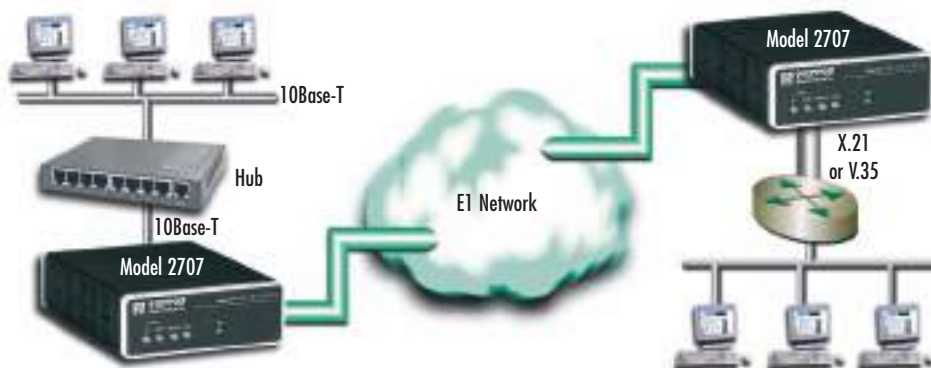

ORDERING INFORMATION

G.703 Interface Converter

2707/C/UI: G.703 to V.35, 100–240 VAC

2707/D/UI: G.703 to X.21, 100–240 VAC

2707/I/UI: G.703 with 10Base-T interface 100–240 VAC

2707/C/48: G.703 to V.35, 48 VDC

2707/D/UI: G.703 to X.21, 48 VDC

2707/I/UI: G.703 with 10Base-T interface 48 VDC

2707RC/A/I: Access Rack Card G.703 to V.35

2707RC/D/D: Access Rack Card G.703 to X.21

2707RC/C/IA: Access Rack Card G.703 with 10Base-T interface

MicroLink-E1™ E1/FE1 Nx64 CSU/DSUs

Model 2715

Miniature NTU terminates framed or unframed 2-Mbps E1/FE1 (G.703/G.704) circuits.

The Patton Model 2715 Network Termination Unit (NTU) terminates 2.048-Mbps E1 (clear channel) and fractional E1 (nx64) 4-wire circuits. Housed in our MicroPak enclosure, the Model 2715 plugs directly into the V.35 DTE interface of a router, switch, FRAD, multiplexer, or other networking device.

The Model 2715 supports all necessary G.703/G.704 diagnostics, including CO line loopback (LLB), payload loopback (PLB), DTE local/remote loops, and V.54 loop up/loop down. Diagnostics are initiated via the Model 2715's control port, or through the DTE or line interfaces. Easily readable LED indicators include TD, RD, Loss of Sync (LOS), Alarm, Error, Test and Power.



Configuration of the Model 2715 standalone is done through the control port or using DIP switches. (The Model 2701RC rack card is configured through the control port or SNMP.)

Model 2715 presents a RJ-45 120-ohm interface to the line and a V.35 interface to the customer's device using a male M/34 connector (the Model 2701RC rack card is available with a female M/34). An M/34 to DB-60 adapter cable is available for convenient connection to Cisco routers. The Model 2715 is powered by an external universal input 100–240 VAC adapter.

FEATURES & BENEFITS

- ✓ Terminates 2.048 Mbps E1 (clear channel) and FE1 (nx64) 4-wire digital services
- ✓ Built-in V.35 (M/34) male connector (DB-60 Cisco router adapter cable is available)
- ✓ Standalone (Model 2715) and rack mount cards (Model 2707RC) are available
- ✓ Diagnostics include LLB and PLB; DTE local and remote loops; V.54 loop up and loop down
- ✓ AMI or HDB3 line coding
- ✓ Configuration via DIP switches or control port
- ✓ External 100–240 VAC power supply



Rack card units available, see page 104

Typical application

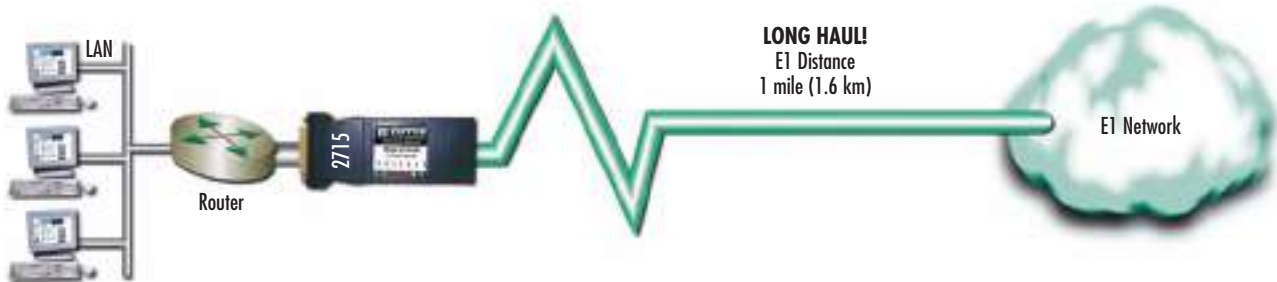

Also available with DB-60 cable for Direct Connection to Cisco Routers.

SPECIFICATIONS

WAN connection: 8-position connector (RJ-45)
Nominal impedance: 100 ohm
WAN speed: 2.048 Mbps
DTE interface: Integral V.35 (M/34 male)
Line coding: E1 - AMI/HDB3
Receive LBO: Automatic

Transmit LBO: Selectable—0, 7.5, or 15 dB
Clock options: Internal, external, and network clock
Diagnostics: Respond to CO line loopback (LLB) and payload loopback (PLB) via control port and DTE initiate remote LLB and remote PLB (all loops are bi-directional with respect to the DTE);

DTE local and remote loops (bi-directional); V.54 loop-up/loop-down as detected in the data stream
Standards: G.703/704, G.732
Power: 120 VAC, 60 Hz to 5VDC 300mA wall mount transformer or UI 100–240VAC, 50 Hz to 5 VDC, 3A wall mount transformer

ORDERING INFORMATION

2715/CM/UI: MicroLink-E1™ E1/FE1 Nx64 CSU/DSU; V.35, M/34 male; 100–240 VAC power
2715/CM/48: Stand alone NTU; V.35 (M/34F) interface; -48 VDC power

Co-directional G.703 Converters

Model 2070

Plug-in access converter for G.703/64 kbps.



The Model 2070 Series interface converters allow a router—or similar WAN device—with a V.24 (RS-232), V.35 or X.21 port to connect to a G.703/64k co-directional (PCM) network.

Offering switchable internal, external or network clocking options, Model 2070 Series converters support bi-directional, synchronous communication at a data rate of 64 kbps.

The Model 2070 Series includes three variations: The Model 2070/AM plugs directly into an RS-232 DTE, and is equipped with a male DB-25 connector. The Model 2070/CM plugs directly into a V.35 DTE, and is equipped with an M/34 male connector. The Model 2070/DM plugs into an X.21 DTE, and is equipped with a male DB-15 con-

necter at the end of a 6 ft (15.25 cm) cable. All versions come with an RJ-45 jack for 120-ohm twisted-pair network termination (termination to a 75-ohm network can be accomplished using the Patton Model 460 balun).

Model 2070 Series converters incorporate local loopback and G.703 loopback diagnostic modes. Diagnostic modes are controlled by a switch, or by the local DTE (V.24 or V.35 versions only). Rear panel LED indicators monitor test mode and synchronization. Synchronous clock jitter is attenuated in accordance with the G.823 specification. For protection against ground loops and transient surges, the Patton Model 2070 Series converters incorporate both transformer isolation and surge protection.

Power is supplied to the Model 2070 Series converters by an external power supply. When used in a point-to-point environment, distances up to 5,250 ft (1600 m) are attainable using two 24 AWG (0.5mm) twisted pairs.

FEATURES & BENEFITS

- ✓ Bi-directionally converts V.24, X.21, or V.35 to G.703/64 kbps co-directional
- ✓ Synchronous operation at 64 kbps
- ✓ Internal, external, or network clocking options
- ✓ Point-to-point distance up to 5,250 ft (1600 m) on 24 AWG (0.5mm) twisted pair
- ✓ Complies with CCITT/ITU G.823 jitter control specifications
- ✓ Built-in surge protection and transformer isolation

ORDERING INFORMATION

2070/AM/UI: G.703/64 kbps converter (RS-232, DB-25 male, 100–240 VAC power)

2070/CM/UI: G.703/64 kbps Converter (V.35, M/34 male, 100–240 VAC power)

2070/DF/UI: G.703/64 kbps converter (X.21, DB-15 female, 100–240 VAC power)

Typical application



SPECIFICATIONS

Applications: 64k/G.703 co-directional PCM network or CSU/DTE conversion to CCITT/ITU V.24, CCITT/ITU V.35, or CCITT/ITU X.21

G.703 Interface: Symmetrically balanced pairs, 4 wire, 120 ohm terminated to female RJ-45

Operating Speed: Co-directional timing, Rx recovered: 64 kbits + 500ppm.

Clocking: Internal, External or Network Timing

G.703 Input Signal Level: 2.0V differential, into 120 Ohms, nominal.

Max. Cable Loss: 0 to -10dB

Line Encoding: AMI

Jitter Performance: CTR 14, G.823

Surge Protection: Device Response Time—100ns; Clamp Voltage—8.5V ±1V.

Isolation: 1500 VRMS isolation, transformer coupled.

Indicators: LEDs monitor TM and SYNC.

Power Requirements: 5VDC at 300mA, supplied by external transformer or on these DTE pins: pin 9 (V.24), pin KK (V.35), pin 15 (X.21)

Temperature Range: 32–140°F (0–60°C)

Dimensions: Model 2070/AM 4.90 x 2.00 x 0.73 in. (12.45 x 5.08 x 1.85 cm); Model 2070/CM & 2070/DF 3.40 x 2.00 x 0.73 in. (8.63 x 5.08 x 1.85 cm).

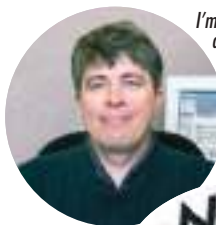

I'm Martin, Patton's Sales Representative for Central/Eastern Europe. Call me at +1 301.975.1000 x376 when you want to purchase or if you have questions about our products. You can also send e-mail to martin@patton.com.



G.703/64-kbps Interface Converter

Model 2073

Standalone PCM converter supports Patton's QuikConnect™ modules.

The Patton Model 2073 KiloLink-1™ G.703/64 kbps co-directional access converter lets bridges, routers, switches, multiplexers, and other WAN hardware connect to a Kilo-Stream™ or similar G.703 circuit. Operating in either clear channel or octet timing modes, the Model 2073 offers three clocking options and seven front panel LED status indicators. Built-in transformer isolation and surge protection guard the Model 2073 and connected hardware against data line transients and



ground loops. Power is provided to the Model 2073 through an internal AC power supply.

FEATURES & BENEFITS

- ✓ Switchable internal, external, or network clocking options
- ✓ Supports synchronous data rates of 9.6 to 64 kbps
- ✓ Supports asynchronous data rates of 9.6 to 19.2 kbps
- ✓ Clear channel or octet timing
- ✓ Accepts Patton QuikConnect modules
- ✓ Internal power supplies, 100–240 VAC, or -48 VDC

Typical application



I'm Tshaka, one of Patton's Support Engineers. If you're having a problem with a Patton product, I'll find the solution quickly. To buy one of these state-of-the-art ipDSLAMs, call +1 301.975.1000 or send e-mail to sales@patton.com.

SPECIFICATIONS

G.703 Interfaces: 64 kbps, symmetrically balanced, 4-wire pair, 120-ohm terminated to a female RJ-45

DTE Interface: V.24/RS-232, V.35, X.21, G.703, Data+Voice, Ethernet Bridge

Data Rates: V.110 rate adaptation for asynchronous data rates from 50 bps to 57.6 kbps, and for synchronous data rates from 500 bps to 64 kbps

Operating Modes: 256 kbps rate co-directional timing, Rx recovered; 64 kbps+500ppm (clear channel); or with BPV for octet timing mode to communicate over a 128-kbps link (preservation of byte integrity)

Diagnostics: local analog loopback, remote digital loopback, V.52 compliant bit error rate pattern (511/511E pattern) gen-

erator and detector with error injection mode

Line Coding: AMI

Clocking: Internal, external, or network clock

G.703 Input Signal Level: 0 to -10 dB, 2V differential, nominal

Jitter Performance: CTR14, G.823 Isolation: Minimum 3000V RMS via custom transformers

Surge Protection: 600W power dissipation

Range: 0.5 mile (0.8 km)

Power: 100–240 VAC, 50/60 Hz (universal input option); 48 VDC (option); 5 watts

Dimensions: 7.3 x 6.6 x 1.62 in. (18.5 x 16.8 x 4.1 cm)

Weight: 2.02 lbs (0.92 kg)

ORDERING INFORMATION

G.703/64 kbps Interface Converter

2073/A/UI: V.24, DB-25F, 100–240 VAC power

2073/B/UI: RS-422/530, DB-25F, 100–240 VAC power

2073/C/UI: V.35, M/34F, 100–240 VAC power

2073/D/UI: X.21, DB-15, 100–240 VAC power

2073/D/UI: Ethernet, RJ-45, 100–240 VAC power

Multi-Service Access

Dial-up RAS Servers & Digital Cross Connect (DACS) Solutions

Carrier Class RAS



"Big Red" Remote Access Server

- ✓ Card-based solution scales from **96 to 1,560** V.92/V.90/V.34/ISDN modem calls
- ✓ Fully redundant, hot-swappable power, cooling, and alarm systems
- ✓ Three different chassis sizes accept all power and function cards interchangeably
- ✓ Each function card is an autonomous access system able to be configured, maintained, managed, and swapped independent of other cards
- ✓ Embedded SNMP/HTTP management system

See pages 114–115

ISP RAS



"Red RAS" Remote Access Server

- ✓ Answers from **12 to 120** V.92/V.90/V.34/ISDN modem calls
- ✓ Three different 1U-high "pizza-box" platforms.
- ✓ Redundant AC/DC power options standard
- ✓ Integrated Ethernet, T1, E1, and uplink ports support any network architecture
- ✓ SNMP and Web-based/HTTP management systems

See pages 116–121

Multi-Service Cross-Connect

- ✓ Scalable chassis system and 1U-high cross-connect platforms
- ✓ Any-port-to-any-port DS0-level cross-connect functionality
- ✓ Redundant AC and DC power options
- ✓ SNMP and Web-based/HTTP management system with a full suite of end-to-end local and remote diagnostics and alarm facilities

ForeFront DACS



Miniature Access Node DACS



T1/E1 Ports	16–271	4–16
STM-1	2 + 2	—
OC-3	2 + 2	—
Models	2616RC/6511RC	2604, 2608, 2616

See pages 126–133

Data, Dial-up, and Voice

Enterprise RAS



“DialFire RAS” Remote Access Server

- ✓ Answers up to **60** V.90/V.34/ISDN modem calls or G3 fax
- ✓ Choose from ISDN BRI or PRI interfaces
- ✓ Works in standard PCI 2.1 (5 or 3.3 volt) slot
- ✓ SNMP and Web-based/HTTP management systems
- ✓ A wide range of OS and third-party application support

See page 122

Micro RAS



“Tiny RAS” Remote Access Server

- ✓ Answers **1** analog modem call
- ✓ Converts any dial-up modem into a single-port remote access server
- ✓ Supports full DHCP and private IP address assignment
- ✓ AC or DC power options

See page 123

In This Section

Carrier Class RAS	114
ForeFront RAS 2U, 4U, & 6U Chassis Systems	114
ISP RAS	116
16, 24, 30, 48 or 60-Port RedRAS	116
96 or 120-Port RedRAS	118
96 or 120-Port Dial-up RedRAS	120
Enterprise RAS	122
Server-Based Remote Access	122
Micro RAS	123
Micro Serial RAS	123
Multi-Service Cross Connect (DACS)	125
ForeFront Multi-Port DACS	125
Digital Cross Connects	126
4 & 8-Port DACS	128
Low-Cost Managed DACS	130
16-Port DACS	132
Universal Access Rack	134
1001 Rack System, High Density, 2U High, 16 slot	134
Universal Mounting Panels	138
1001MP2 Mounting Panel, 1.5U High, 2slot	138
1001MP10 Mounting Panel, 4U High, 10slot	138
1001MP16 Mounting Panel, 2U High, 16 slot	139

Universal Access Rack

- ✓ One rack supports a wide range of last-mile technologies
- ✓ Very low profile — only 2U high
- ✓ Ideal for carriers, universities, hospitals, and hotels deploying one-card-per-subscriber systems



See pages 134–137

ForeFront RAS
ForeFront 3125RC

The ForeFront RAS is the all-new carrier-class addition to Patton's dial-up access solutions.



The ForeFront RAS provides the ILEC/IOG, CLEC and PTT with a powerful and scalable access solution.

Building upon Patton's award-winning 2900 series of remote access servers, the ForeFront RAS offers increased port density, enhanced performance, and expanded service capabilities. Scaling from 96/120 ports per blade, a single chassis can support up to 1,560 calls. Through its unique

distributed processing architecture, each blade operates independently of other system cards for maximum uptime. With support for enhanced data systems such as remote access services, the ForeFront RAS supports future multi-service access capabilities such as VoIP and DSL.

Designed to ensure no single point-of-failure for maximum uptime and high availability, the ForeFront RAS's modular platform incorporates redundant AC or DC power supplies and hot-swappable/field-upgradable network resource cards providing a versatile, scalable, and complete remote access solution.

FEATURES & BENEFITS

- ✓ High density scalable architecture for easy expansion
- ✓ 96/120 ports per resource card—up to 1,560 calls
- ✓ Dual redundant Hot-Swap architecture
- ✓ Dual 10/100 Ethernet ports per resource card with multiple routing
- ✓ On-board expansion port for additional services and VPN processing
- ✓ V.92/V.44 and legacy modem support
- ✓ Complete SNMP/HTTP management



A **PMC expansion port**—Network expansion options enable the 3125RC to offer new revenue opportunities



B **Dual 10/100 Ethernet Ports**—Allow flexible integration options for your high-performance network. Each 10/100 Ethernet provides a primary and secondary port



C **SNMP/HTTP management**—Embedded HTTP server provides complete configuration and control using a web browser, as well as standard tools

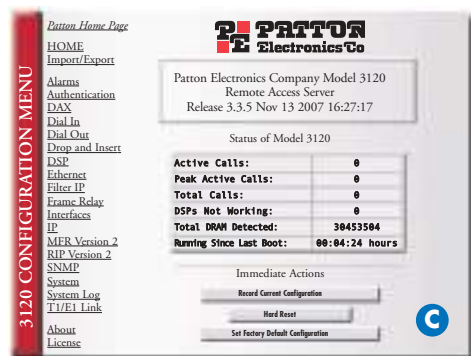

D **Quad T1/E1 ports for 120 ports of RAS or uplink services**—Terminate any combination of modems/ISDN connections, or expand into remote locations and use the 3120 as a complete PoP solution

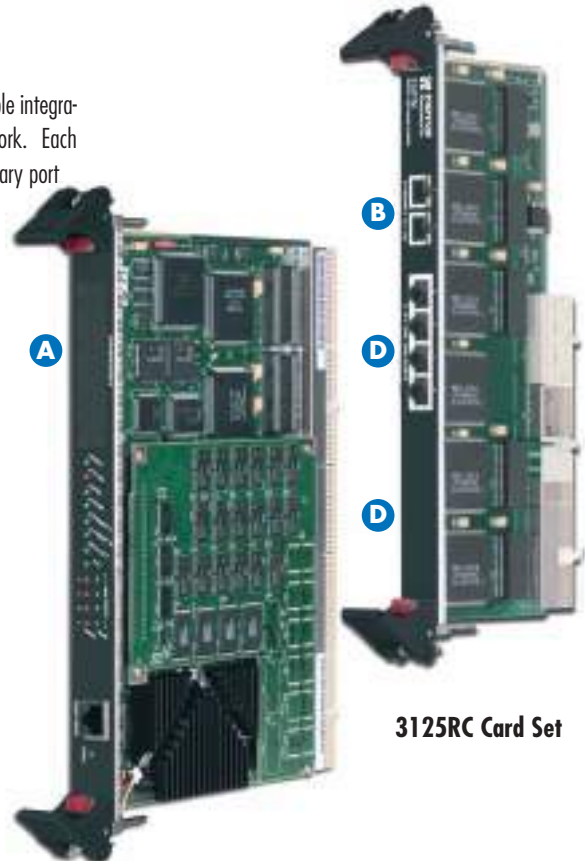

3125RC Card Set

Corporate site/remote office/POP

Patton designed the ForeFront RAS to meet the infrastructure requirements of service providers and corporations who rely on multi-service access servers for their networks. Employees working in remote offices; mobile users; and telecommuters access the network from various line types for critical data and applications required to perform their daily tasks. The ForeFront RAS uses the latest DSP technology to terminate both analog (V.92, V.90, K56Flex, V.34+) and digital ISDN modem calls with the future ability to augment multi-service capabilities.

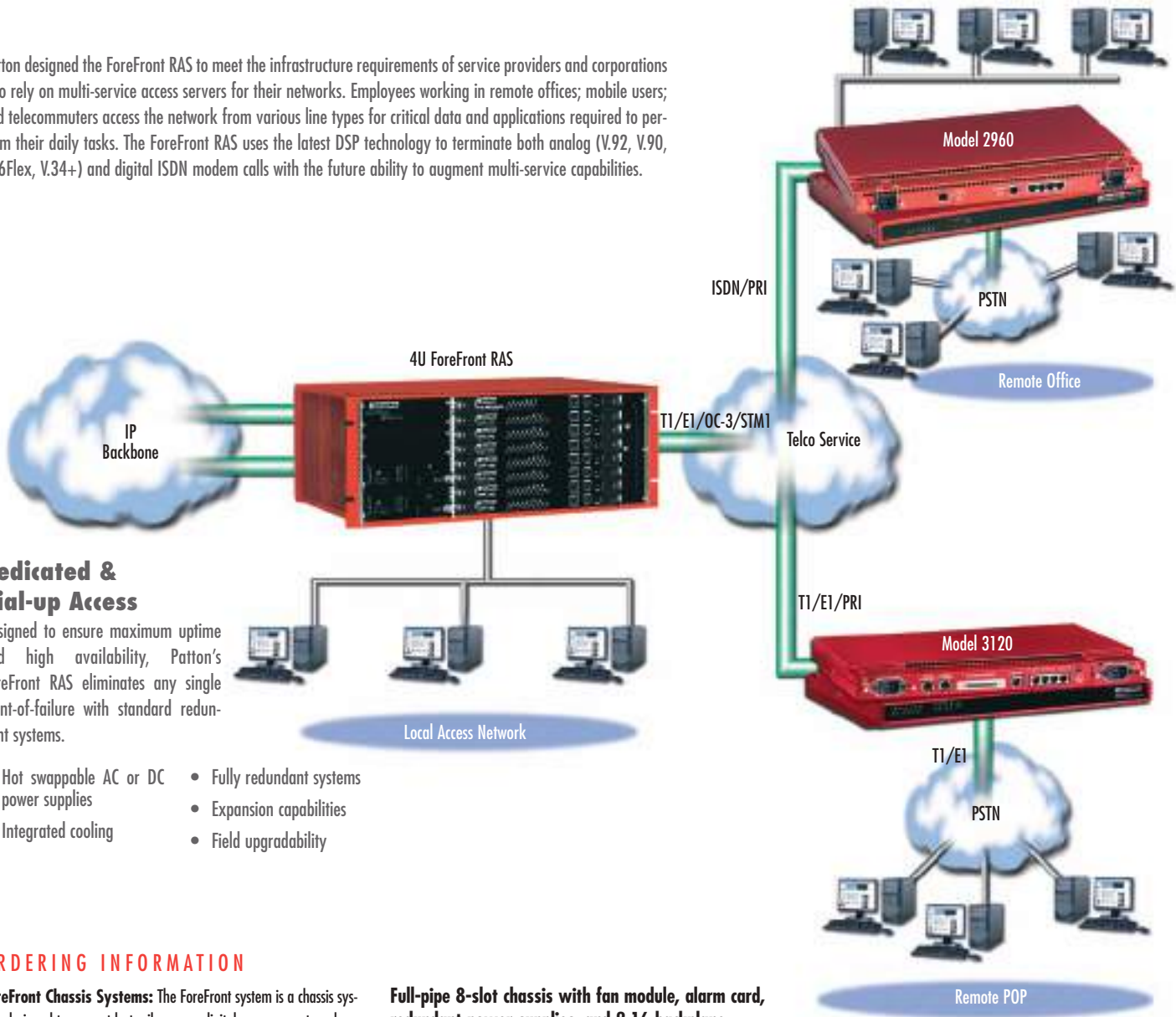

Dedicated & Dial-up Access

Designed to ensure maximum uptime and high availability, Patton's ForeFront RAS eliminates any single point-of-failure with standard redundant systems.

- Hot swappable AC or DC power supplies
- Fully redundant systems
- Integrated cooling
- Expansion capabilities
- Field upgradability

ORDERING INFORMATION

ForeFront Chassis Systems: The ForeFront system is a chassis system designed to support last-mile access, digital cross connect, and remote access services. The models below are for RAS applications only. For combination systems, consult a Patton Systems Engineer.

Remote access server card set

3125RC/96: 96-port RAS card with T1/E1 transition module

3125RC/120: 120-port RAS card with T1/E1 transition module

Half-pipe 4-slot chassis with fan module, alarm card, redundant power supplies, & H.110 backplane

6276R/RUI: Universal AC supplies

6276R/R48: Universal DC supplies

Full-pipe 8-slot chassis with fan module, alarm card, redundant power supplies, and 2.16 backplane

6476R/RUI: Universal AC supplies

6476R/R48: Universal DC supplies

Xtreme 17-slot chassis with fan module, alarm card, redundant power supplies, and 2.16 backplane

6676R/RUI: Universal AC supplies

6676R/R48: Universal DC supplies

Note: For additional options associated with these chassis refer to page 68.

visit us online
www.patton.com

FAST Delivery From Your AUTHORIZED DISTRIBUTOR!



I'm Maria, one of Patton's Sales Coordinators. If you have questions about our products, call +1 301.975.1000 or send e-mail to sales@patton.com.

16, 24, 30, 48, or 60-Port RedRAS
Model 2960

This new remote access server provides 16, 24, 30, 48, or 60 dial-up ports, each supporting V.92, V.90, K56Flex™, V.34+, and ISDN connections.



The Patton 2960 RAS is an ideal solution for the Internet Service Provider that is expanding into a new calling area. By integrating capabilities into our 2960 Remote Access Server, the ISP lowers expansion costs and produces revenue immediately.

The 2960 RAS offers 16, 24, 30, 48, or 60 analog and digital modems, RAS software, a 10/100 Ethernet port, IP Routing, Frame Relay forwarding, and four T1/E1

CSU/DSUs. It connects up to 60 dial-in-modem V.92, V.90, K56Flex, V.34+ or ISDN users to the Internet, IP LANs, or Corporate Intranets. Load-sharing dual-redundant power supplies and integrated Web-based SNMP/HTTP management system capabilities make our Model 2960 RAS the most reliable and easiest to use RAS in the business!

Built-In WWW-based management

The NetLink Remote Access Server can be managed by a variety of local and remote methods, simultaneously. Each RAS has a built-in SNMP agent, an embedded HTTP web server (using a standard browser, such as Microsoft Internet Explorer or Netscape Navigator), and a TELNET management interface.

All forms of management are available through the Internet, any dial-up port, the RS-232 console port, or the Ethernet port. Operators can configure, control, monitor, or receive status from any interface.



I'm Steve, one of Patton's Engineers designing remote access products. To buy one of these state-of-the-art devices, call +1 301.975.1000 or send e-mail to sales@patton.com.

FEATURES & BENEFITS

- ✓ Up to 60 ports in a 1U-high platform
- ✓ Dynamic analog/digital modems
- ✓ Frame relay & PPP network uplinks
- ✓ SNMP/HTTP network management
- ✓ MultiLink and multichassis support
- ✓ Dual-redundant power supplies — standard

Why use our Model 2960 RAS?

From HTTP management to dual-redundant power supplies to FR/PPP uplink integration, the NetLink Model 2960 provides an all-in-one package for the expanding ISP. Featuring:

- Integrated T1/E1 uplink ports with Frame Relay and PPP.
- Convection-cooled system. There are no fans or moving parts to fail.
- The lowest cost-of-ownership for an ISP or Telco building a remote POP for 16, 24, 30, 48, or 60 ports.

The Model 2960 requires half the space of most existing RAS solutions. With greater reliability and a smaller package than any of its competitors, the Model 2960 is the value leader in the industry.

Patton Home Page
 HOME
 Import/Export
 Alarms
 Authentication
 DAX
 Dial In
 Dial Out
 Drop and Insert
 DSP
 Ethernet
 Filter IP
 Frame Relay
 Interfaces
 IP
 MFR Version 2
 RIP Version 2
 SNMP
 System
 System Log
 T1/E1 Link
 About
 License

PATTON
Electronics Co.

Patton Electronics Company Model 2960
 Remote Access Server
 Release 3.3.5 Nov 8 2007 14:09:46

Status of Model 2960

Active Calls:	9
Peak Active Calls:	20
Total Calls:	1532
DSPs Not Working:	0
Total DRAM Detected:	38506336
Running Since Last Boot:	5 days 06:43:49 hours

Immediate Actions
 Record Current Configuration
 Hard Reset
 Set Factory Default Configuration

2960 remote access server configuration in a remote POP

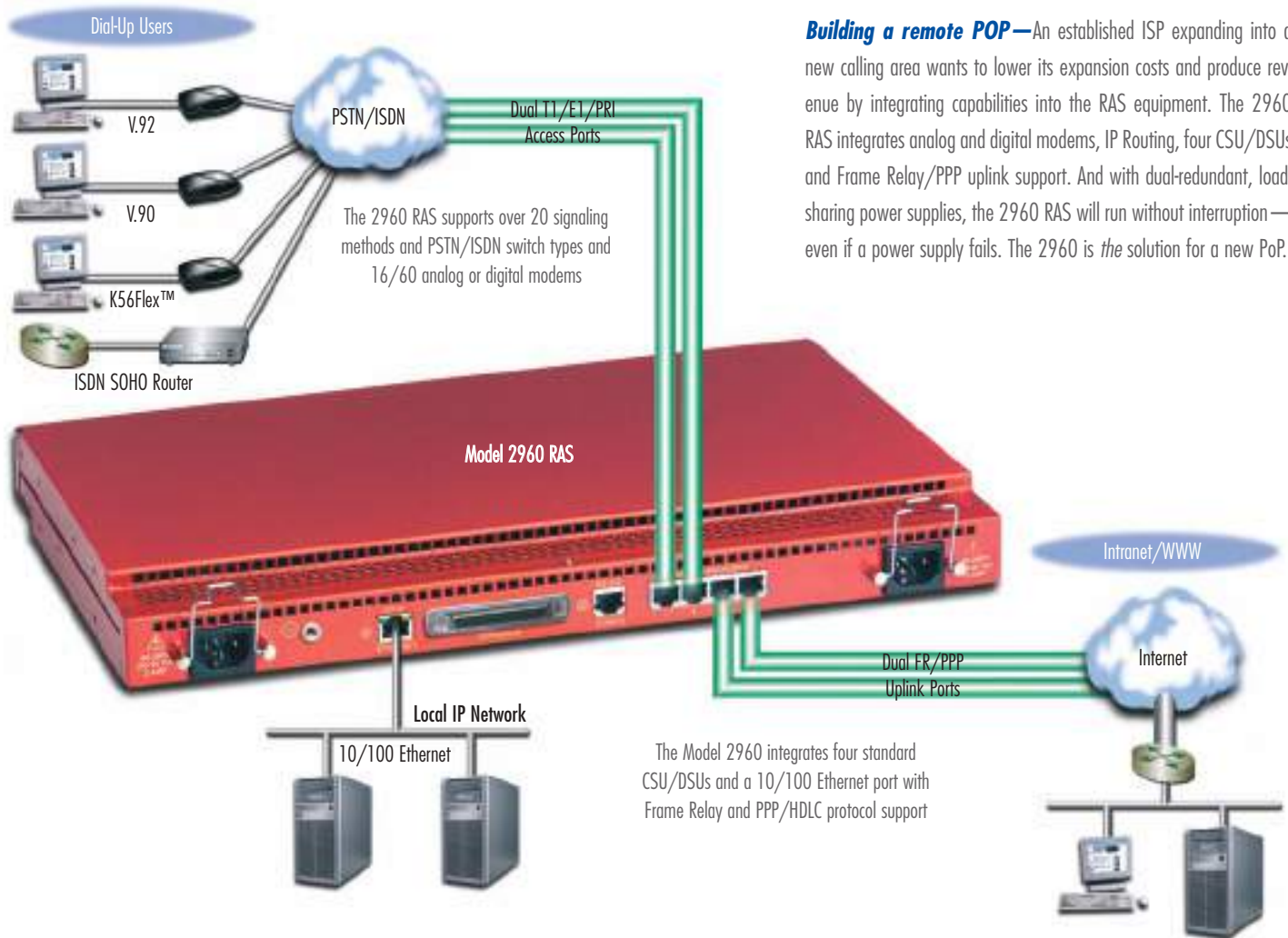

Building a remote POP—An established ISP expanding into a new calling area wants to lower its expansion costs and produce revenue by integrating capabilities into the RAS equipment. The 2960 RAS integrates analog and digital modems, IP Routing, four CSU/DSUs and Frame Relay/PPP uplink support. And with dual-redundant, load-sharing power supplies, the 2960 RAS will run without interruption—even if a power supply fails. The 2960 is *the* solution for a new PoP.

SPECIFICATIONS

Number of Connections: 16, 24, 30, 48, or 60

Power Supplies: Dual Redundant (Fixed) AC or DC

Ethernet Ports: One 10/100Base-T

WAN Ports: Four

Management Services: HTTP, SNMP, TELNET Dial-in and Ethernet or RS-232 console port, SYSLOG client, Remote software upgrade via FTP, User configurable login prompts and banners

Authentication: RADIUS, PAP/CHAP, Username/Password, and Static Users Database (111 Entries)

Modem Modulations: V.92, V.90, K56Flex™, V.34 Annex 12, V.34, V.32bis, V.32, V.23, V.22, V.22bis, V.21, Bell 212A, Bell 202, Bell 103, EIA-PN-2330, V.8, V.8bis, Sync/Async receiver/transmitter for V.14, V.44, V.59, V.42/V.42bis error correction & compression

PSTN Signaling: E1 Primary Rate interface (Q.931), E1 MFR2 (R2), T1 Primary Rate Interface, T1 Robbed bit with

Loop/Ground Start or E&M Wink, E&M Immed, Taiwan R1 & Drop & Insert

Software Upgrades: Achieved through Flash upgrades via FTP (upgrades available from www.patton.com)

Protocol Services

- TCP/IP suite with extensive protocol statistics
- ICMP/TFTP/FTP/RLOGIN/TELNET
- Point-to-Point Protocol (PPP)
- SLIP protocol
- Ethernet ARP, Proxy ARP and RARP protocols

- Van Jacobson TCP header compression
- PPP address and protocol compression
- MultiLink PPP
- RADIUS authentication and accounting, with support for primary and secondary servers
- RIP, RIPv2 and OSPF dynamic route distribution—user configurable static routes
- Multi-chassis MultiLink
- Layer 3 and Layer 4 IP Filtering

ORDERING INFORMATION

2960/16R/RUI: Dual T1/E1/PRI, 16-port RAS, 100–240 VAC

2960/24R/RUI: Dual T1/PRI, 24-port RAS, 100–240 VAC

2960/30R/RUI: Dual E1/PRI, 30-port RAS, 100–240 VAC

2960/48R/RUI: Dual T1/PRI, 48-port RAS, 100–240 VAC

2960/60R/RUI: Dual E1/PRI, 60-port RAS, 100–240 VAC

2960/16R/R48: Dual T1/E1/PRI, 16-port RAS, 48 VDC power

2960/24R/R48: Dual T1/PRI, 24-port RAS, 48 VDC power

2960/30R/R48: Dual E1/PRI, 30-port RAS, 48 VDC power

2960/48R/R48: Dual T1/PRI, 48-port RAS, 48 VDC power

2960/60R/R48: Dual E1/PRI, 60-port RAS, 48 VDC power

96 or 120-Port RedRAS

Model 2996

This remote access server provides 96 or 120 dial-up ports, each supporting V.92, V.90, K56Flex™, V.34+, and ISDN connections.



FEATURES & BENEFITS

- ✓ 96 or 120 ports in a 1U-high platform
- ✓ Dynamic analog/digital modems
- ✓ 10/100 full-duplex, Auto-sensing Ethernet LAN port
- ✓ Multichassis Multilink enables the 2900 Series RAS to scale in high-density PoPs and works with all Patton RAS.
- ✓ Integrated WWW server for managing and configuring all 2996 RAS functions
- ✓ Frame relay & PPP network uplinks
- ✓ SNMP/HTTP network management
- ✓ Dual-redundant power supplies

The 96/120-port Model 2996 is the latest addition to our NetLink RAS family. Expanding ISPs will be delighted by its dual-redundant power supply, redundant DSPs, no moving parts, and FR/PPP uplink ports.

The Model 2996 supports 96 or 120 digital ISDN or analog (V.92, V.90, K56Flex, V.34+, etc.) modem connections in a single 1U-high (1.75 in./4.45 cm), 19-inch wide rackmount chassis.

Its standard features include 96 or 120 analog and digital modems, RAS software, 10/100 Ethernet port, IP Routing, Frame Relay forwarding, and four T1/E1 CSU/DSUs. It connects 96 or 120 dial-in-modem V.92, V.90, K56Flex, V.34+ or ISDN users to the Internet, IP LANs, or corporate intranets. Load-sharing dual-redundant power supplies and integrated Web-based SNMP/HTTP management system capabilities make our 2996 RAS the most reliable and easiest to use RAS in the business!



I'm Yuri, one of Patton's Engineers designing remote access products. To buy one of these state-of-the-art devices, call +1 301.975.1000 or send e-mail to sales@patton.com.

High density dial-up access

Dial-up RAS systems have come a long way since the days of 1200-bps modems, terminal servers and bulletin boards. The NetLink RAS uses the latest in digital signal processor (DSP) technology to terminate analog (V.92, V.90,

K56Flex, V.34+, etc.) and digital (ISDN BRI) modem calls. This architecture provides the highest density and ensures the highest connection speeds at the lowest possible costs. With technology advances driving the continued reduction in

price-per-port, ISPs and corporate customers alike will benefit from expanding their dial-up access with the Patton NetLink RAS system.

Virtual modem pooling application diagram



Remote access services for enterprises

The new corporate office is quickly being redefined as “any place where work is being done.” Legislative mandates, high-way traffic and employee retention issues are speeding the growth of teleworking. As more companies respond to this trend, reliable remote access equipment is needed.

The Model 2996 remote access server provides dial-up access to company e-mail, to the corporate Intranet and to other resources for teleworkers and remote users. The Model 2996 delivers the right solution for small, medium and large offices.

Network Access on the Road

On the road, users want to get online quickly, send their reports and get their e-mail (see diagram at left). The Model 2996 offers fast V.92/ISDN/Mobile connections. By providing a built-in modem pool, users won't get busy signals either. The next available modem will answer.

The 2996 includes built-in analog and digital modems, support for new services like the wire access protocol (WAP) and support for well-known services like V.44 compression. If the goal is to get on and off the network quickly, the Model 2996 offers the fastest turnaround time.

Teleworking Access

Rather than fight traffic, teleworkers answer their e-mail messages or work at home each day (see diagram at left). Their requirements are for client-server intranet access and the greater bandwidth this application demands. The Model 2996 provides for this through integrated ISDN support and the combining of services using standards-based Multichassis and MultiLink. With MultiLink, the bandwidth available from two or more calls is combined to provide the dial-up user a blazingly-fast connection. It's just like being at the office—without the travel and the hassles required to get there.

Branch Office Access

When teleworking prohibits the right level of customer contact or employee interaction, a remote or satellite office may be the right answer (see diagram at left).

Corporate network managers can outfit a small office with a Model 2996 RAS. Now, users can access their e-mail, check status reports on the Intranet and upload projects to their colleagues at headquarters. Patton's low-cost Model 2996 makes this possible.

Enterprise/teleworking application diagram

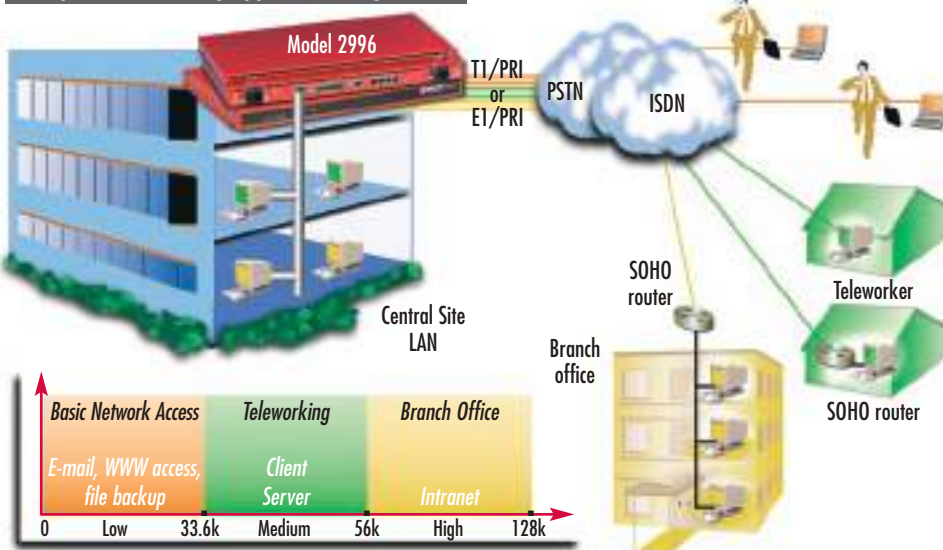

Why corporations deploy the 2996 RAS

Saves On Office Costs—Maintaining common work areas for flex-time staff saves money. Employers spend an average of \$10,000 per employee providing basic office space, insurance and other infrastructure. Remote staff costs less.

Helps Retain Employees—Most corporations spend 30% of an employee's salary to recruit the employee. Offering even a little relief to sitting in traffic and providing your employees with more-flexible work hours pleases your workforce and promotes employee retention.

Extends Geographic Reach—From business services to recruiting new employees, offering network access and telecommuting programs makes your company more competitive and attractive.

Environmentally Responsible—You can do your part to improve air quality before being subject to pending legislation, regulation and local ordinances.

It Just Makes Sense—The number of US telecommuters continues to grow as businesses realize telecommuting is fiscally sound, good for employees and environmentally responsible.

SPECIFICATIONS

Number of Connections: 96 or 120

Power Supplies: Dual Redundant (Fixed) AC or DC

Ethernet Ports: One 10/100Base-T WAN Ports: Four

Management Services: HTTP, SNMP, TELNET Dial-in and Ethernet or RS-232 console port, SYSLOG client, Remote software upgrade via FTP, User configurable login prompts and banners

Modem Modulations: V.92, V.90, K56Flex™, V.34 Annex 12, V.34, V.32bis, V.32, V.23, V.22, V.22bis, V.21, Bell 212A, Bell 202, Bell 103, EIA-PN-2330, V.8, V.8bis, Sync/Async receiver/transmitter for V.14, 4.44/V.59/V.42/V.42bis error correction & compression

Authentication: RADIUS, PAP/CHAP, Username/Password, and Static Users Database (111 Entries)

PSTN Signaling: E1 Primary Rate interface (D.931), E1 MFR2 (R2), T1 Primary Rate Interface, T1 Robbed bit with

Loop/Ground Start or E&M Wink, E&M Immed, Taiwan R1 & Drop & Insert

Software Upgrades: Achieved through Flash upgrades via FTP (upgrades available from patton.com)

Protocol Services

- TCP/IP suite with extensive protocol statistics
- ICMP/TFTP/FTP/RLOGIN/TELNET
- Point-to-Point Protocol (PPP)
- SLIP protocol
- MultiLink PPP

- Ethernet ARP, Proxy ARP and RARP protocols

- Van Jacobson TCP header compression PPP address and protocol compression

- RADIUS authentication and accounting, with support for primary and secondary servers

- RIP, RIPv2 and OSPF dynamic route distribution—user configurable static routes

- Multi-chassis MultiLink
- Layer 3 and Layer 4 IP Filtering

ORDERING INFORMATION

2996/96R/RUI: Dual E1/PRI, 96-port RAS, 100–240 VAC

2996/120R/RUI: Dual E1/PRI, 120-port RAS, 100–240 VAC

2996/96R/R48: Dual T1/PRI, 96-port RAS, 48 VDC power

2996/120R/R48: Dual E1/PRI, 120-port RAS, 48 VDC power

96 or 120-Port Dial-up RedRAS

Model 3120

This new flexible platform delivers enhanced remote access services

The 3120 supports up to 120 digital ISDN or analog (V.90, V.92, K56Flex, V.34+, etc.) modem connections in a single 1U-high (1.75 in./4.45 cm) rack-mount chassis. It is the highest density, lowest profile remote access server available anywhere. With its dual-redundant hot-swappable power supplies, the 3120 RAS protects against single-point

power failures. Additionally, it has two 10/100-Mbps Ethernet ports for load sharing and traffic balancing.

For maximum flexibility, the 3120 has a slot for an optional expansion module. For example: ISPs can add VPN functionality on dedicated DSL ports for increased revenue opportunities. The 3120 is a one-of-a-kind network access unit.

FEATURES & BENEFITS

- ✓ Quad T1/E1/PRI WAN ports
- ✓ Up to 120 simultaneous V.90, V.92 or ISDN connections
- ✓ Dual 10/100 Ethernet ports
- ✓ Integrated IP Router
- ✓ SNMP/HTTP management
- ✓ Expansion port for universal VPN, compression, and DSL
- ✓ 1U high 19 in. stackable chassis
- ✓ AC and DC power options
- ✓ Dual-redundant hot-swappable load-sharing power supplies



A Hot-swap removable dual-redundant power is standard

Supports two AC, two DC, or a mix of AC and DC power supply modules



D PMC expansion card—Network expansion options enable the 3120 to offer new revenue opportunities



C SNMP/HTTP management—Embedded HTTP server provides complete configuration and control using your web browser

3120 CONFIGURATION MENU

- Patton Home Page
- HOME
- Import/Export
- Alarms
- Authentication
- DAX
- Dial In
- Dial Out
- Drop and Insert
- DSL
- Ethernet
- Ether IP
- Frame Relay
- Interfaces
- IP
- MER Version 2
- RIP Version 2
- SNMP
- System
- System Log
- T1/E1 Link
- About
- License

PATTON Electronics Co.

Patton Electronics Company Model 3120
Remote Access Server
Release 3.3.5 Nov 13 2007 16:27:17

Status of Model 3120

Active Calls:	0
Peak Active Calls:	0
Total Calls:	0
DSPs Not Working:	0
Total DRAM Detected:	38453584
Running Since Last Boot:	08:04:24 hours

Immediate Actions

Record Current Configuration

Hard Reset

Set Factory Default Configuration

B Quad T1/E1 ports for 120 RAS or uplink services—Terminate any combination of 120 modems/ISDN connections, or expand into remote locations and use the 3120 as a complete PoP solution



E Dual 10/100 Ethernet Ports—Flexible, redundant integration options for your high-performance network



Dial-up and dedicated access application diagram

Dedicated & dial-up access

The 3120 RAS is designed to scale with your customer's requirements: from dial-up V.92 analog to ISDN 128kbps to dedicated xDSL and fractional T1/E1. Its modular expansion slot can be used for three basic applications:

- Dedicated access using integrated xDSL modems
- Advanced services like Virtual Private Networking (VPN)
- Wide area network uplinks and serial ports, like V.35

And modular expansion means more customers, larger billings for newer Managed Access Services and an overall faster return on your RAS equipment investment. The 3120 RAS delivers a tightly integrated dial and dedicated access platform that your future requires.

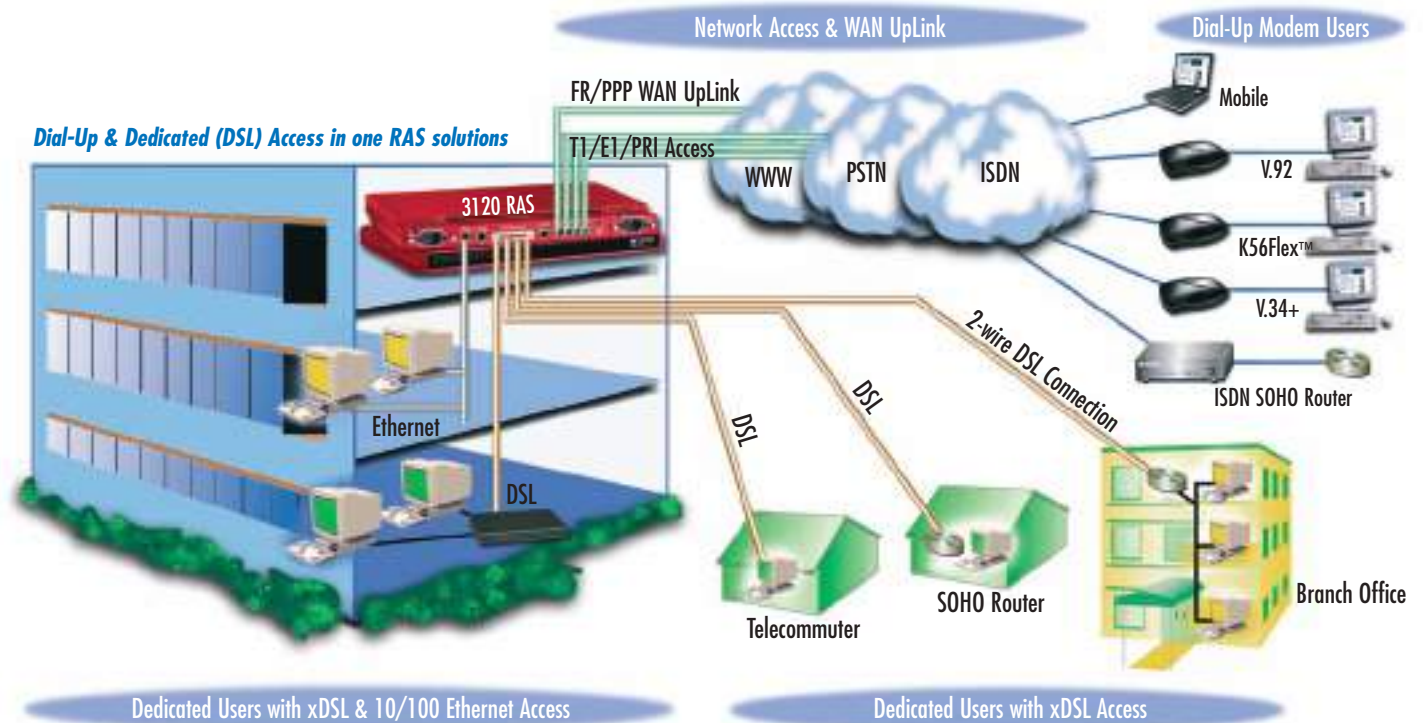

I'm Sean, Patton's Director of Sales for North America & Japan. Call me at +1 301.975.1000 when you want to purchase Patton products or if you have questions about our products. You can also send e-mail to sales@patton.com.

Resources Available By Request
Televisa Case Study Article
Hotel Remote Access Applications White Paper
User Operations Manual
RAS FAQ
RAS Brochure
"I love my RAS..." White Paper

On-Line Resources
Build Yourself an ISP White paper
RAS Product Overview
RAS key Selling Points
RAS Sales overview
T1/E1/PRI Tutorial
Introduction to: TCP/IP, PPOP/SLIP, and RADIUS White Papers

SPECIFICATIONS

LAN: Dual auto-sensing 10/100 full-duplex Ethernet ports w/primary & secondary IP addresses

LAN Protocols: TCP/IP suite with integrated IP router, RIP, RIPv2, OSPF, RADIUS, TELNET, RLogin, TCP Raw, HTTP, SNMP

WAN: Quad T1/E1/PRI RJ-48C ports
WAN Protocols: Async. and Sync. PPP, MLPPP, Multi-chassis MLPPP, SLIP, Frame Relay (RFC-1490)

Signaling: Robbed-bit, R1, R2, Q.921/Q.931

Modems: Up to 120 V.92, V.90, K56Flex, V.34+, or ISDN B-channel digital calls

Software: Upgradable via FTP, free updates from www.patton.com

Temp.: 0 to +40°C (0 to 104°F)
Humidity: 5 to 95%, non-condensing
Power: Dual-redundant, load-sharing, requires less than 40 Watts of power
AC: 90 to 264 VAC
DC: 36 to 72 VDC

Dimensions:
1.75H (1U) x 17W x 10.0D in.
(4.44H x 43W x 025.4D cm), convection-cooled, NEBS Level 3

ORDERING INFORMATION

3120/96R/RUI: Quad T1/PRI, 96-port, expandable RAS

3120/120R/RUI: Quad E1/PRI, 120-port, expandable RAS

3120/PS-UI: 90–260 VAC universal input power supply

3120/120R/R48: Quad E1/PRI, 120-port, expandable RAS

3120/96R/R48: Quad T1/PRI, 96-port, expandable RAS

3120/PS-48: 36–72 VDC input power supply

* Country-specific power cord included.

Server-Based Remote Access

Model 2977A DialFire T1/E1 RAS & FAX Adapter

Supporting open-standards remote access, fax, data collection, and modem pooling, the Model 2977 DialFire RAS server-based RAS offers up to 60 ports in a single PCI slot.

For demanding, server-based applications including modem-pooling, remote access, advanced fax, World Wide Web and branch office internetworking, you won't find a better product line than the Patton's Model 2977 DialFire RAS.

The Model 2977 DialFire DSP-based RAS concentrator provides the widest compatibility and most powerful performance available in a PCI slot. Patton's Model 2977 DialFire adapters support a full range of con-



nections, from low density to high density T1/E1 and Primary Rate Interface (PRI) ISDN. Multiple Model 2977 Digital Domain adapters can be installed in a single server so capability can be added as system needs grow.

FEATURES & BENEFITS

- ✓ Dynamic analog/digital/fax support—On-board DSPs provide advanced modem & fax support and maximize the efficiency of each communication channel
- ✓ Field upgradable from 24/30 ports to 48/60 ports supporting up to two 61/E1 ports
- ✓ Advanced DSP Technology—Supports V.90, K56Flex, ISDN, and Advanced FAX applications
- ✓ Wide OS and third-party application support—The Model 2977 DialFire RAS integrates with, and take advantage of, the inherent communications capabilities built-in to your current server operating environments like; Microsoft, Novell, SCO, and Linux
- ✓ Web-based management—The Model 2977 Digital Domain RAS hardware manager provides web-based reporting, diagnostics, and advanced troubleshooting tools
- ✓ Universal server compliance—The Model 2977 Digital Domain RAS operates within the PCI 2.1 mechanical and electrical specifications, support 3.3 or 5-volt PCI servers, and share common software architecture

SPECIFICATIONS

Modem Data Modes: V.90, K56Flex, V.34, V.34bis, V.32bis, V.32, V.24bis, V.23, V.22bis, V.22, V.21, Bell 212a, Bell 103, TIA TSB37-A, TIA TSB38

Compliance: FCC Part 15A, CE Mark, EMC Directive 89/336/EEC, Low-Voltage Directive 73/23/EEC

FAX Command Set: Group 3 FAX Class 1, Group 3 FAX Class 2, Group 3 FAX Class 2.0, Class 2.0 Error Correction, All optional 2.0 Data format conversions are supported including: Normal Image, Fine Image, 1D Image Conversion, 2D — MR Image conversion, Copy Quality Checking & Receiving Thresholds.

Adaptive Answering, TSI Banner, Distinctive Ring, Caller ID, and IS-101 Voice Command Set.

ISDN Specifications: Primary Rate Interface: D-Channel Signaling, ISDN Data Link Layer ITU-T Q.921, ISDN Call Control Signaling ITU-T Q.932/L451

Compression & Error Correction: V.42bis, MNP Class 2, MNP Class 4, MNP Class 5, V.42 Error Correction (LAPM & MNP)

T1/E1 Specifications: T1 Supervision Modes: Ground Start Signaling, Wink Start Signaling, Immediate Start Signaling, & Loop Start.

E1 Supervision Modes: CCS with CRC4 ITU G.704, CAS with CRC4 ITU G.704, CRC4 with Remote End Block Error signaling, and R2 Signaling

Fax Modes: Group 3, V.17, V.29, V.27, V.21 Channel 2

Certifications: Safety: USA: UL Recognized, UL 1950—Canada: CSA Certified, CSA C22.2 No.950—Europe: EN60950—CE Mark—Australia: AS3260. Telecom—USA: FCC Part 68, Canada: CS03, Europe: I-CTR4 (NET 5), Australia: TSO38, Emission & Immunity — EN50082 Immunity, FCC Part 15, Subpart B

Op. Temp.: 32–122°F (0–50°C)

Humidity: 5–90% non-condensing

Air Movement: 30 CFM Forced

Altitude: 0–12,000 ft (0–3,660 m)

Operating System Support: Microsoft: Windows 2000 Server, Windows XP/Windows NT 4.0 • Novell: Netware 4.1, Netware 4.1.1, & Netware 5.1 • SCO: UnixWare 7 SVR5, Open-Server 5 • Linux

Dimensions: Model 2977 24, 30, 48, & 60 12.28L x 4.20W in. (31.199L x 10.688W cm)

Model 2977 Daughter Cards 7.10L x 3.80W in. (18.034 x 9.652 cm)

ORDERING INFORMATION

2977/24/PT1: 24 Port RAS Card, Single T1 WAN

2977/48/PT2: 48 Port RAS Card, Dual T1 WAN

2977/30/PE1: 30 Port RAS Card, Single E1 WAN

2977/60/PE2: 60 Port RAS Card, Dual E1 WAN

2977/24/PTM: Daughterboard (Upgrades 24-Port RAS to 48 Ports)

2977/30/PEM: Daughterboard (Upgrades 30-Port RAS to 60 Ports)

2977A DialFire RAS configuration in a Corporate Fax Server

Many Companies today rely of faxes to communicate with their customers. From hospitals to distribution companies, having the ability to send faxes simultaneously is a must. With Patton's 2977 DialFire RAS, setting up a fax server is easier than ever. For companies with large faxing requirements, the 2977 RAS adapters for digital & analog communications combine Patton's world-class hardware with high-speed ISDN access to provide up to 60 simultaneous connections.

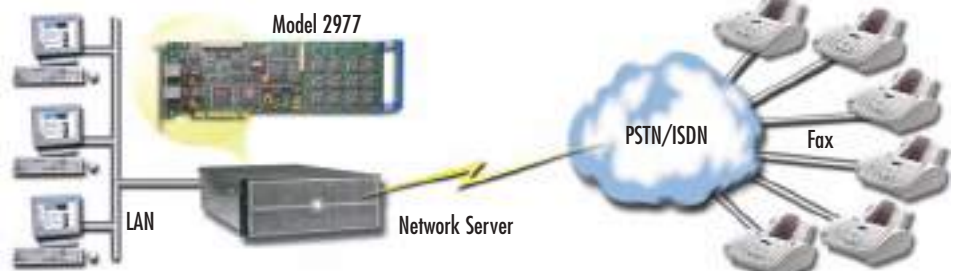

Micro Serial RAS

Model 2120

Converts your dial-up modem into a remote access server



Patton's Model 2120 converts your dial up modem into a single port Remote Access Server. By connecting the Model 2120 into the RS-232 serial port of your modem, a dial-in user will automatically be connected to a user defined IP host and Port Number. Simplicity is enhanced by the Model 2120's support for Dynamic Host Control Protocol (DHCP) private IP address assignment. DHCP support relieves the user of the need of applying for and configuring an IP address for each and every device on the LAN. The Model 2120 security features include PAP (Password Authentication Protocol) which verifies incoming calls through an internal database.

FEATURES & BENEFITS

- ✓ Supports a Wide Range of Data Rates (0–115.2 kbps)
- ✓ Ethernet Link and Status indicators
- ✓ Free Software Updates
- ✓ Standard TCP/IP with PPP/SLIP
- ✓ DTE/DCE-selectable serial port
- ✓ Small package attaches directly to serial ports
- ✓ RS-232 status indicators
- ✓ AC or DC Power Options



Now available with
a DB-9 connector

Application diagram

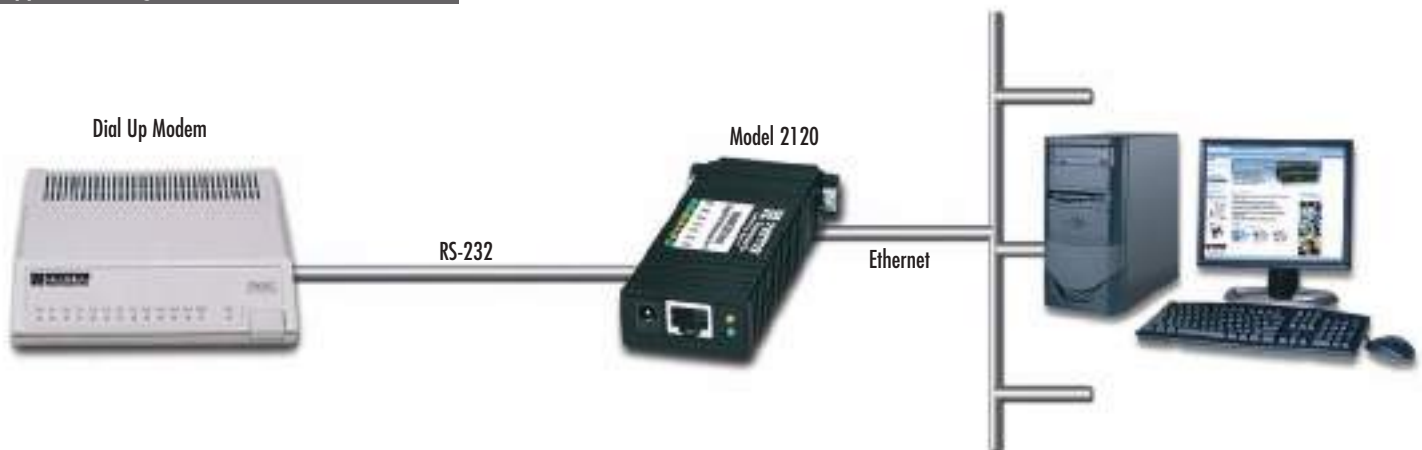

SPECIFICATIONS

Mechanical Interface: DB9 or DB25 connectors
Ethernet: RJ-45 Female Shielded
Transmission: RS-232 Asynchronous 0–115.2 kbps
Protocols: TCP, TCP RAW, UDP, IP, DHCP, TELNET, ICMP, ARP, SLIP, PPP
 Firmware upgrade via FTP, Domain Name Server (DNS or WINS).
Security: PPP PAP, RADIUS Authentication
DTE/DCE: User-selectable through TELNET session

Management: Monitoring, control, and diagnostics through serial port or via TELNET session
Power Source: External, Universal Input, 120VAC, or optional DC (-12V, -24V, or -48V)
Memory: 1 Mbyte of RAM; 512 kbytes of FLASH
Op. Temp.: 32–122°F (0–55°C)
Dimensions: 3.5L x 2.1W x .78H in. (9.0L x 5.3W x 1.9H cm)
Weight: 0.2 lbs (0.09 kg)

ORDERING INFORMATION

- 2120/AM/UI:** Single Port RS-232 Terminal Server, Asynchronous, DB-25 Male, UI Power Supply
- 2120/AM/48:** Single Port RS-232 Terminal Server, Asynchronous, DB-25 Male, -48 VDC Power Supply
- 2120/AF/UI:** Single Port RS-232 Terminal Server, Asynchronous, DB-25 Female, UI Power Supply
- 2120/AF/48:** Single Port RS-232 Terminal Server, Asynchronous, DB-25 Female, -48 VDC Power Supply

- 2120/A9M/UI:** Single Port RS-232 Terminal Server, Asynchronous, DB-9 Male, UI Power Supply
- 2120/A9M/48:** Single Port RS-232 Terminal Server, Asynchronous, DB-9 Male, -48 VDC Power Supply
- 2120/A9F/UI:** Single Port RS-232 Terminal Server, Asynchronous, DB-9 Female, UI Power Supply
- 2120/A9F/48:** Single Port RS-232 Terminal Server, Asynchronous, DB-9 Female, -48 VDC Power Supply

visit us online
www.patton.com

FAST Delivery From Your AUTHORIZED DISTRIBUTOR!

PATTON
Electronics Co.

More Dial-Up

Patton's RAS

...Less Dollars

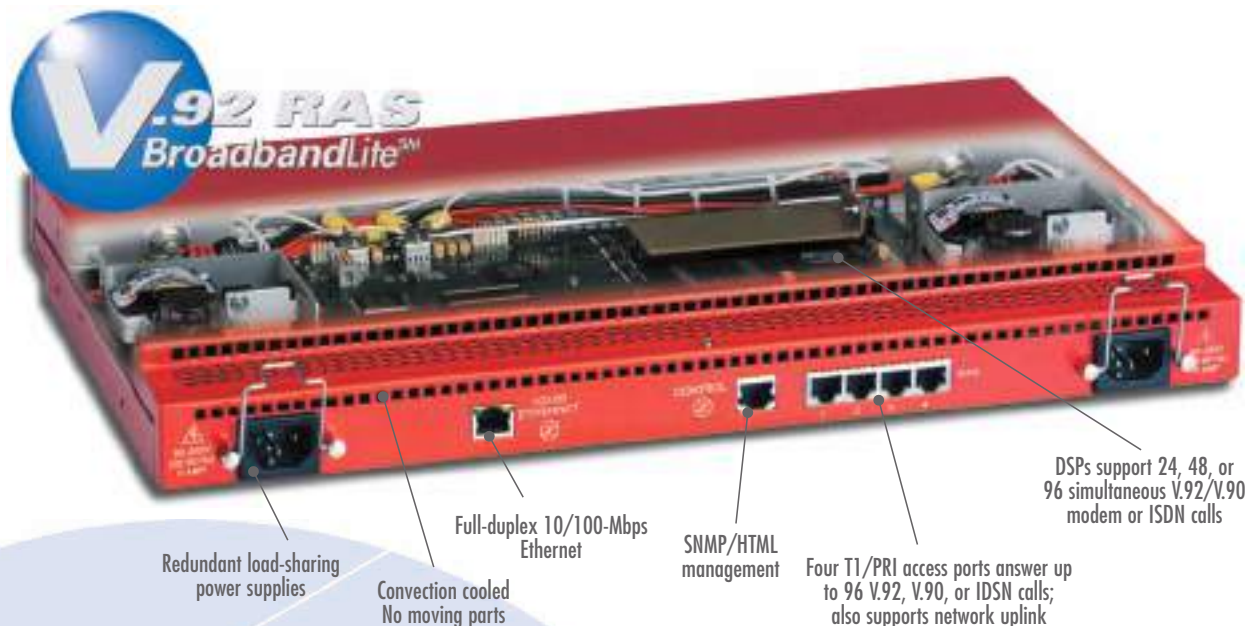

Patton's RAS gives you more!

More RAS, Less Rack.

Up to 96 simultaneous modem (V.92, V.90, etc.) or ISDN calls in 1U of rack space.

More Features, Less Cash.

No nasty extra charges for software features like V.92, ISDN etc., and all software updates are FREE.

More Support, Less Hassle.

Free support lines and e-mail are answered promptly by top-notch problem solvers.

More Management, Less Software.

Web based and SNMP/HTTP means you can manage your box from anywhere in the world.

More Customers, Less Churn.

V.92 is a big reason for customers to stay with a provider or switch to one that offers V.92.

More Fun, Less Work.

All of this means you will spend less money for our RAS, have more customers, realize more profits, and have a bit more time to relax.

With Patton, you will get more for less.

Most RAS manufacturers give you LESS and take MORE for it. You pay dearly for all the "extras"...like rack-ears, redundant power, or V.92. You pay for a support program that leaves you on hold or your e-mail messages unanswered. You pay more and you get less...but it doesn't have to be that way!

With Patton, you will get more for less. We give you everything you need in one box with no hidden costs or charges; no upgrade fees for dual power supplies or rack ears, uplink ports or software updates. You get more support, more functionality, more ports and consequently more customers.

Visit...

www.patton.com/RAS

PATTON
Electronics Co.

ForeFront™ Multi-Port DACs
Model 6500 Series Digital Cross Connects

Patton's ForeFront™ 6500 Series DACs are carrier grade, non-blocking digital cross connects that offer scalable any-to-any DSO mapping in an expandable, modular chassis.



The Patton ForeFront™ 6500 Series DACs are carrier grade digital cross connects with unparalleled redundancy and upgradeability. Whether used as a cross connect or a multiplexer for TDM aggregation, ForeFront DACs are flexible, rugged and easily upgradeable.

Patton combines software-programmable T1/E1 ports with integrated CSU/DSUs and STM-1 ports in a fully non-blocking, any-to-any DSO switching fabric. Every Model 6511RC STM-1 module can cross-connect and multiplex traffic down

to the DSO level, allowing for aggregation of DSO timeslots into TU-12s without requiring a separate fabric slot.

ForeFront DACs offer power distribution, thermal management, and a redundant high-speed backplane. All ForeFront 6500 Series DACs come ready to install in a standard 19-in. rack. Each DACs has an integrated cooling system that is field replaceable and serviceable without interrupting system operation. Flexible power options include 1+1 or N+1 redundant field replaceable AC or DC supplies. Redundant power feeds provide added power failure protection. Support for up to four external clocks to guarantee synchronization with the TDM network.

Hot-swappable modules guarantee high availability. With manageability built into every single module the system is capable of sustaining continuous operation and capable of being continuously manageable even in the face of multiple failures. ForeFront 6500 Series DACs are available in 4-slot 2U high, 8-slot 4U high and 17-slot 9U high chassis configurations.

FEATURES & BENEFITS

- ✓ Clock Synchronization—Configure any port as a clock source with up to four external sources and one internal fallback source.
- ✓ STM-1 Resolves DSOs—STM-1 interface can resolve, aggregate and cross-connect traffic down to the DSO level.
- ✓ Non-Blocking Cross Connect—Take any TDM channel from any port and perform a Drop & Insert to any other port.
- ✓ Port Fallback—Fallback ports can be configured for any ports to ensure non-stop operation.
- ✓ Fault Tolerant Processing—Each port module can continuously sustain switching with it's own built-in processor.
- ✓ Complete Alarm Facilities—Configurable alarm reporting with SNMP traps, front panel LEDs and syslog messages.
- ✓ Multiple Built-in BITS Sources—Every port module include a BITS port for clocking synchronization.
- ✓ SNMP/HTTP Management—SNMP/HTTP management is included in every port module for easy web browser based management.

SPECIFICATIONS

STM-1 Ports: Single mode dual SC fiber (20km) per G.957 using 1310 nm lasers per G.652 and Dual 75-Ohm BNC per G.703

T1/E1 Ports: Software configurable: T1 (AMI/BBZS line coding) or E1 (HDB3/AMI line coding), G.703, G.704, G.723

WAN Clocking: STM-1: STM-1—G.813; STS-3 - ANSI T1.101-1999,

T1.105.09-1995, G4-1244 • **T1/E1:** Network, Receive Recover, Internal or via BITS port

High Speed Mid-plane: Redundant, high speed TDM busses supporting 4096 non-blocking DSO cross connect over 32 independent busses

Mgmt. Ethernet Ports: Per Module 10/100Base-T (RJ-45 connector); auto-negotiating; half or full duplex operation

Front Panel Indicators: LEDs for power, CPU, system, Ethernet, External clock, and test mode

Management Service: HTTP, SNMP, Telnet Ethernet, RS-232 Console Port, SYSLOG Client, Software upgrade via FTP/TFTP

Alarm Reporting: Configurable alarms; Remote SNMP Traps; Front Panel LEDs

Compliance: Safety: UL/CSA per UL1950 (METS) Canadian cMET and CS-03, EMC Directive 89/336/EEC, Low-Voltage Directive 73/23/EEC (EN60950), FCC Part 15, CE Mark, CTR12, CTR13, FCC Part 68

Environment: Operating temperature: 0–40°C (32–104°F) Humidity: 5–90% non-condensing

ORDERING INFORMATION

6511RC/M155/SC20/EBNC: Single Port STM-1 Matrix Switch with SMF & Dual BNC

I'm Natalie, Patton's Inside Sales Manager, US & Canada. Call me at +1 301.975.1000 when you want to purchase Patton products or if you have questions about our products. You can also send e-mail to sales@patton.com.

Application diagram



visit us online
www.patton.com

FAST Delivery From Your AUTHORIZED DISTRIBUTOR!



Digital Cross Connects

Models 2616RC & 6500 Series ForeFront-based DACs

Highest density, scalable DACs solution for Telco and carrier environments

The Model 2616RC is the answer for high density T1/E1 digital cross connection and grooming in carrier and telco environments. Offering any-to-any DSO mapping, the Model 2616RC comes with 16 T1/E1 user-programmable ports in a 6U-high card. Up to 13 cards can be housed in Patton's 19-in. ForeFront chassis system, giving you a staggering 208 T1/E1 ports!

Using a robust hardware platform and a rich set of software features—including an intuitive, graphical SNMP/HTTP user interface—the 2616RC can be used in a series of applications ranging from non-blocking cross connection; to multiplexing; to transport of E1 over T1 lines, or vice versa.

The Model 2616RC features an RS-232 console port and a 10/100Base-T port. The RS-232 port provides access to VT-100 configuration menus, while the 10/100Base-T port allows remote configuration and monitoring via Internet connection from any location in the world. For remote configuration, the

Model 2616RC comes with a built-in web server, which provides intuitive drop-down menus for simple configuration testing and monitoring. For complete flexibility, The Model 2616RC can also be managed using any standard SNMP software tool.

The Model 2616RC works with Patton's 4, 6, and 13-slot ForeFront system chassis (for more information, see ForeFront Chassis System on page 68). Twisted-pair connections provide standard T1 and E1 interfaces, while RS-232 console and 10/100Base-T ports enable complete command and control of the card. Dual-redundant power supplies—with choices of DC or AC inputs—ensure uninterrupted operation and service. Front panel LEDs provide at-a-glance status of system and network signals, while a comprehensive set of diagnostics features and alarms enable network personnel to quickly isolate failures and minimize down time.

The 2616RC DACs rack card can also be used in conjunction with Patton DSL, T1/E1 NTUs, fiber optics T1/E1 multiplexers, and network extenders to provide a complete geographical solution to enterprise customers with wide area network deployments.

Cross connect card set



SPECIFICATIONS

T1/E1 Ports: 16 T1/E1 ports: E1 (HDB3/AMI line coding), T1 (AMI/BBZS line coding)

Ethernet Port: One 10/100Base-T (RJ-45 connector)

Clocking: Internal, Network, System (from T1/E1 WAN port)

Front Panel Indicators: LEDs for power, CPU, system, Ethernet, clock

source, clock error, test mode, and WAN ports frame and error status

Management Services: HTTP, SNMP, TELNET, Ethernet, RS-232 Console Port, SYSLOG Client, Remote Software Upgrade via FTP

Alarm Reporting: Configurable alarms; Remote SNMP Traps; Front Panel

LEDs: 3-Contact Relay for local alarm (3-pin terminal block)

Compliance: Safety: UL/CSA per UL1950 (METS) Canadian cMET and CS-03. EMC Directive 89/336/EEC, Low-Voltage Directive 73/23/EEC (EN 60950), FCC Part 15, CE Mark, CTR12, CTR13, FCC Part 68.

Op. Temp.: 0–50°C (32–122°F)

Humidity: 5–90% non-condensing

Dimensions:

Front blade: 0.75H x 10.5W x 6.30 in. (1.9H x 26.7W x 16.0D cm)

Rear blade: 0.75H x 10.5W x 3.15D in. (1.9H x 26.7W x 8.0D cm)

FEATURES & BENEFITS

- ✓ Any-to-any DSO mapping across single or multiple cards
- ✓ 16 T1/E1 ports—switch up to 480/64 kbps channels
- ✓ Universal DACs card for use in ForeFront systems
- ✓ DACs, multiplexer, and T1/E1 converter—all in one box
- ✓ Hot-swappable front and rear resource cards
- ✓ Complete local and remote alarm facilities
- ✓ Full suite of T1/E1 diagnostics
- ✓ SNMP/HTTP management

The Model 2616RC is housed in Patton's ForeFront chassis.

ForeFront Xtreme

6U-high chassis (8U with cooling), 16 slots front and rear, up to 4 AC or DC n+1 redundant power supplies



ForeFront Full-Pipe

4U-high chassis (including cooling), 8 slots front and rear, up to 3 AC or DC n+1 redundant power supplies



ForeFront Half-Pipe

2U-high chassis (including cooling), 4 slots front and rear, up to 3 AC or DC n+1 redundant power supplies



Application diagram

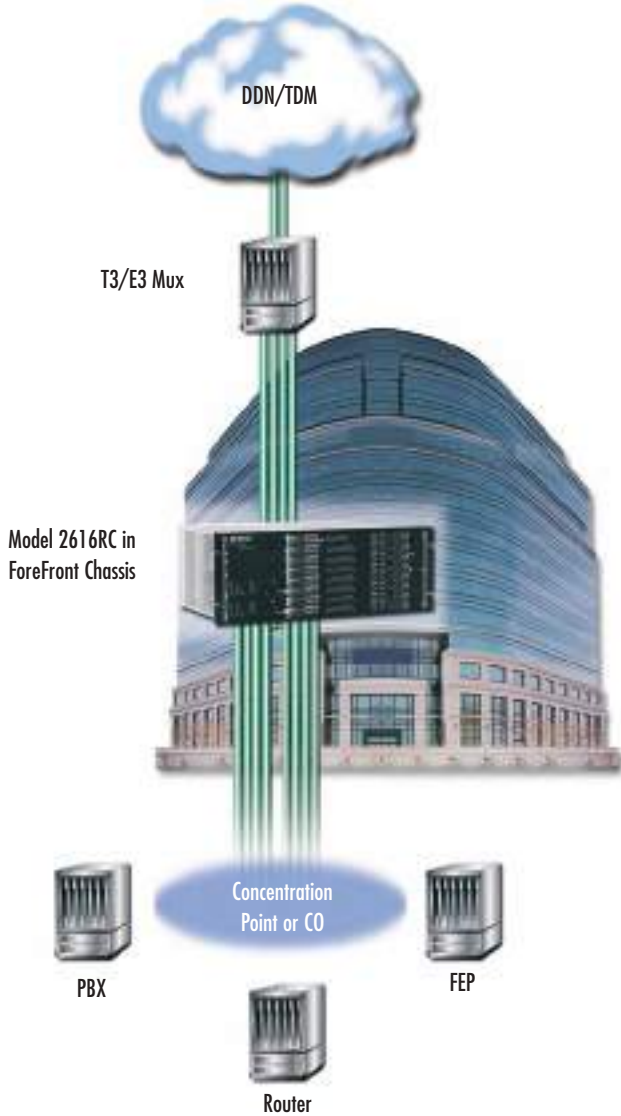

2616RC HTTP/SNMP Configuration Management Screens



The Model 2616RC high density DACs can concentrate and groom Nx56/nX64 kbps channels from T1/E1 lines deployed from an aggregation point—or Central Office—to customer locations. In many instances, customers lease 256 kbps, 512 kbps, or 1024 kbps worth of bandwidth resulting in lines carrying many idle channels, which are then carried inefficiently by T3/E3 multiplexers across the network. Using the Model 2616RC, telcos can groom and aggregate channels from partially used T1/E1 lines from multiple customer sites onto network bound, fully utilized lines for efficient transport by fiber or T3/E3 multiplexers.

I'm Jen, one of Patton's Sales Associates. Call me at +1 301.975.1000 when you want to purchase Patton products or if you have questions about our products. You can also send e-mail to sales@patton.com.

ORDERING INFORMATION

ForeFront Chassis Systems: The ForeFront system is a chassis system designed to support last-mile access, digital cross connect, and remote access services. The models below are for RAS applications only. For combination systems, consult a Patton Systems Engineer.

Cross connect card set

2616RC/16: 16-port cross connect card with T1/E1 transition module

6525/16E: 16 port T1/E1 Cross Connect in 2U high chassis

6525/32E: 32 port T1/E1 Cross Connect in 2U high chassis

6525/48E: 48 port T1/E1 Cross Connect in 2U high chassis

6525/64E: 64 port T1/E1 Cross Connect in 2U high chassis

6545/16E: 16 port T1/E1 Cross Connect in 4U high chassis

6545/32E: 32 port T1/E1 Cross Connect in 4U high chassis

6545/48E: 48 port T1/E1 Cross Connect in 4U high chassis

6545/64E: 64 port T1/E1 Cross Connect in 4U high chassis

6545/1S64E/R48: 1 Port STM-1 & 64 port T1/E1 Cross Connect in 4U high chassis

Half-pipe 4-slot chassis with fan module, alarm card, redundant power supplies, & H.110 backplane

6276/RUI: Universal AC supplies

6276/R48: Universal DC supplies

Full-pipe 8-slot chassis with fan module, alarm card, redundant power supplies, and 2.16 backplane

6476/RUI: Universal AC supplies

6476/R48: Universal DC supplies

Xtreme 17-slot chassis with fan module, alarm card, redundant power supplies, and 2.16 backplane

6676/RUI: Universal AC supplies

6676/R48: Universal DC supplies

Note: For additional options associated with these chassis refer to page 68.

visit us online
www.patton.com

FAST Delivery From Your AUTHORIZED DISTRIBUTOR!



4 & 8-Port DACs

Models 2604 & 2608 Digital Cross Connect Units

Patton's new DACs allows Any-to-Any DSO cross connection at the most affordable price.



The Patton T1/E1 Digital Cross Connect (DACs) series of products makes cross-connection applications simple and affordable, and most importantly, a growth path for future network expansion by offering models with 4 T1/E1 ports (Model 2604), 8 T1/E1 ports (Model 2608) and 16 (Model 2616) T1/E1 ports. (See page 106 for the Model 2616 DACs)

Using a robust hardware platform and a rich set of software features including a intuitive graphical SNMP/HTTP user interface, the DACs series can be used in a series of applica-

tions ranging from non-blocking cross connection, to multiplexing, to transport of E1 over T1 lines, or vice versa.

When enterprise growth includes the use of multiple E1 or T1 lines, the Model 2604 or 2608 DACs are ideal for managing and maximizing the allocation of 64-kbps channels in under-utilized lines, reducing the cost per channel and freeing bandwidth for further growth. Enterprise customers can concentrate data and voice services from local sub T1 and E1 lines onto fully utilized local loop uplink connections with complete freedom and ease of use.

The Model 2604 and 2608 can also be used in conjunction with Patton DSL, T1/E1 NTUs, fiber optics T1/E1 multiplexers, and network extenders, etc. to provide a complete geographical solution to enterprise customers in wide area network deployments.

FEATURES & BENEFITS

- ✓ Model 2604: 4 T1/E1 ports—switch up to 120/64 kbps channels
- ✓ Model 2608: 8 T1/E1 ports—switch up to 240 64-kbps channels
- ✓ DACs, multiplexer, or T1/E1 converter—all in one box
- ✓ SNMP/HTTP management
- ✓ Complete local and remote alarm facilities
- ✓ Full suite of T1/E1 diagnostics
- ✓ Compact 1U chassis
- ✓ Convection cooled design allows stacking with no fans or other moving parts
- ✓ AC/DC dual-redundant power supplies

SPECIFICATIONS

T1/E1 Ports: 4 T1/E1 ports (2604) or 8 T1/E1 ports (2608); E1 (HDB3/AMI line coding), T1 (AMI/B8ZS line coding)

Ethernet Port: One 10/100Base-T (RJ-45 connector)

Clocking: Internal, Network (from T1/E1 WAN port), External BITS (Building Integrated Timing Supply) Clock Source via 3-pin terminal block

Front Panel Indicators: LEDs for power, CPU, system, Ethernet, External clock, test mode, and WAN ports frame and error status

Power Supplies: Dual-redundant universal AC/DC (fixed); AC power: 90–264 VAC (50/60 Hz); DC power: -36 to -72 VDC

Management Services: HTTP, SNMP, TELNET Ethernet, RS-232 Console

Port, SYSLOG Client, Remote Software Upgrade via FTP

Alarm Reporting: Configurable alarms; Remote SNMP Traps; Front Panel LEDs; 3-Contact Relay for local alarm (3-pin terminal block)

Compliance: Safety: UL/CSA per UL1950 (METS) Canadian cMET and CS-03, EMC Directive 89/336/EEC, Low-Voltage Directive 73/23/EEC (EN 60950), FCC Part 15, CE Mark, CTR12, CTR13, FCC Part 68.

Op. Temp.: 0–40°C (32–104°F)

Humidity: 5–90% non-condensing

Dimensions: 48.25W x 32.00D x 4.44H cm (19.00W x 12.60D x 1.75H in.)

2604 HTTP/SNMP Configuration Management Screens

Point-and-click HTTP management menus offer customers the simplest way to configure and monitor the DACs.

DSO Mapping screens display a colorful grid of ports and 64-kbps channels, simply click and drag timeslots from a port to any other port within the grid and the connection will be completed transparently by the DACs. Channels that have active

connections appear in green, inactive channels in red...it doesn't get any simpler than this. Additionally, for those who prefer to enter command line type configuration, the DACs offers the option to switch to command line screens.

T1/E1 configuration screens, offers line configuration by intuitive drop down menus, while the T1/E1 link activity page



offer per link status information, current and historical near and far end line statistics, and alarm configuration... all at the click of a mouse.

For greater flexibility, the DACs management software also allows configuration and monitoring via third party, industry standard SNMP software packages.

ORDERING INFORMATION

4-port DACs

2604/U/RUI: Cobalt Blue, Dual AC supplies

2604/U/R48: Cobalt Blue, Dual DC supplies

Standard product is Cobalt Blue.

8-port DACs

2608/U/RUI*: Cobalt Blue chassis, Dual AC supplies

2608/B/RUI*: Black Ice chassis, Dual AC supplies

2608/W/RUI*: Cool White chassis, Dual AC supplies

2608/R/RUI*: Ultra Red chassis, Dual AC supplies

2608/U/R48: Cobalt Blue chassis, Dual DC supplies

2608/B/R48: Black Ice chassis, Dual DC supplies

2608/W/R48: Cool White chassis, Dual DC supplies

2608/R/R48: Ultra Red chassis, Dual DC supplies

*Country-specific power cords included.

Application diagram

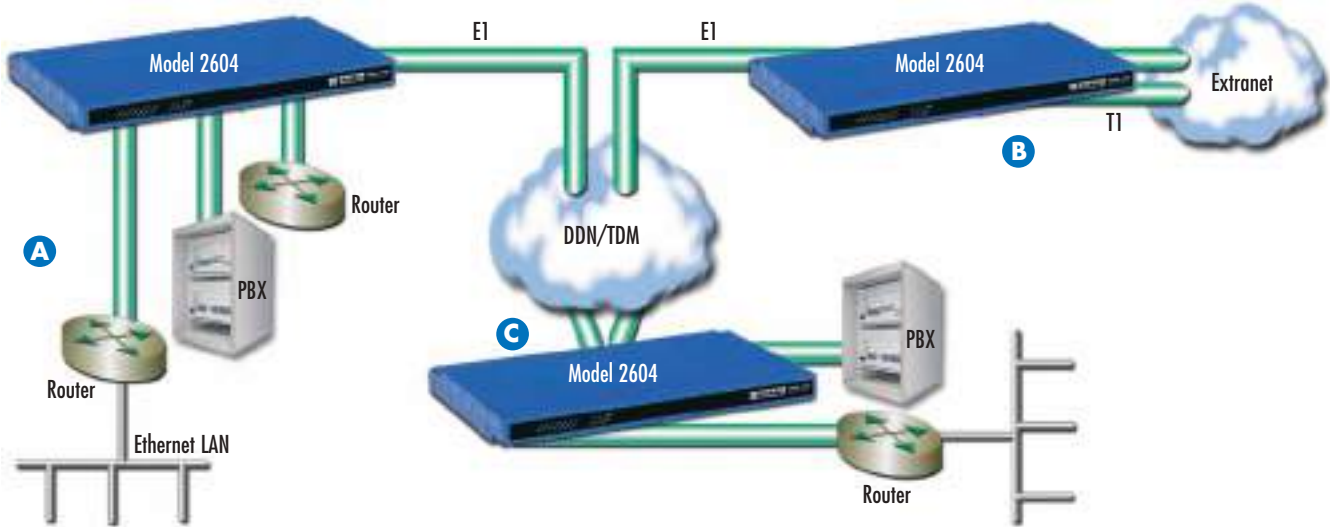

A T1/E1 Aggregation. Medium-size enterprises can aggregate and groom time slots from up to three partially used local T1/E1 lines onto a single outgoing link. This capability enables routers, PBXs, and other network devices dispersed over the campus area to efficiently use a single T1/E1 line for network access.

B T1/E1 Conversion. In situations where T1 and E1 networks converge, ports on the Model 2604 can be configured as E1 or T1 interfaces. This feature provides the capability for mapping and transparently transport T1 64 kbps time slots over E1 lines, and up to 24 E1 channels per T1 line.

C Wide Area Deployment—Local Switching. In a wide area deployment, medium- and large-size enterprises can use the Model 2604 for local timeslot switching from multiple local or remote T1/E1 lines. The model 2604 HTTP/SNMP flexible management allows provisioning and monitoring of switching sites from any remote or central location.

Cell Site Switching Center Access

The explosion of wireless cellular networks in urban and suburban areas creates the need for more efficient transport and access of voice carrying circuits from cell sites to Mobile Telephony Switching Centers. The Model 2616 and the Patton Family of DACS products (4, 8 and 16 port units) enable cellular service providers to efficiently concentrate and groom DSO channels from partially used T1/E1 lines from base stations into fully populated lines for transport to voice switching centers.

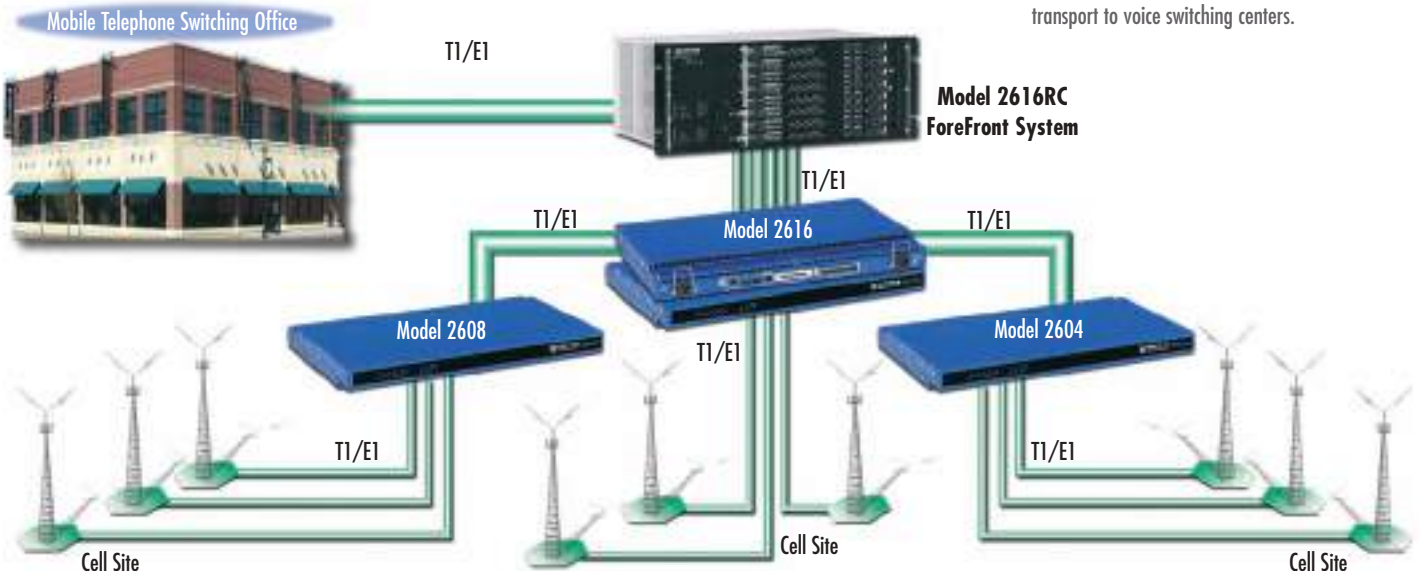

visit us online
www.patton.com

FAST Delivery From Your AUTHORIZED DISTRIBUTOR!



Low-Cost Managed DACs

Model 2614 T1/E1 Digital Cross Connect

Patton's Model 2614 is a managed, low-cost four-port T1/E1 DACs that provides non-blocking any-to-any DSO cross-connect across all ports.



The Model 2614 Managed Digital Cross Connect is the ideal low-cost solution for cross connecting and multiplexing DSOs for up to 4 T1/E1 ports. A good choice for both enterprises and service providers needing to groom and optimize data bearing circuits, the Model 2614 comes in a sleek, desktop package for easy installation in almost any environment.

The Managed DACs is easy to manage and configure. Management can be performed in-band via DSOs or through either of the 10/100/1000 Ethernet management ports. The 2614 comes with a rich CLI as well as with a full HTTP

server to allow easy configuration using any standard web browser. With full SNMP support, any MIB browser or SNMP management platform can easily monitor faults and configure the Managed DACs. A comprehensive set of alarms help network personnel quickly isolate failures and minimize down time. A compact RS-232 console conforming to EIA-564 standards is likewise included.

The Model 2614 Managed DACs is the ideal tool for managing and maximizing the allocation of 64-kbps DSO channels in under utilized lines, reducing the cost per channel and freeing bandwidth for further growth.

FEATURES & BENEFITS

- ✓ Switch up to 124 DSOs—Any-to-any cross connection of up to 124 channels over four T1/E1 interfaces.
- ✓ Easy T1/E1 Aggregation—DSO channels can be easily groomed from different interfaces into one.
- ✓ Dual Gigabit Ethernet Ports—With Dual 10/100/1000, auto-MDI ports easily connect to any LAN infrastructure.
- ✓ SNMP/HTTP Management—Use your favorite Web NMS browser to configure and monitor the Model 2614.
- ✓ In-Band Management via DSO —Configure one or more DSOs for in-band management and remotely deploy and administer the unit.
- ✓ Complete Alarm Facilities—Multiple configurable alarms, reporting via remote SNMP traps, front panel LEDs, 3-contact relay, and NMS pages.
- ✓ Compact Desktop Package—Design avoids the use of fans, reducing moving parts and increasing MTBFs.



I'm Joe, one of Patton's Senior Product Managers. If you have any questions about DACs, please call me at +1 301.975.1000, x137, or send e-mail to joe@patton.com.

Application diagram

The NetLink T1/E1 Low-Cost Managed DACS supports numerous applications ranging from simple local switching of T1/E1 lines, aggregation of DSOs from local T1/E1 lines, or the transparent transport of E1 DSOs over T1 DSOs.

The NetLink T1/E1 Low-Cost Managed DACS comes standard with Dual 10/100/1000 Ethernet ports to easily connect to any local Ethernet based management network. Alternately configure in-band management and use a DSO to pass the management of a remotely deployed unit.

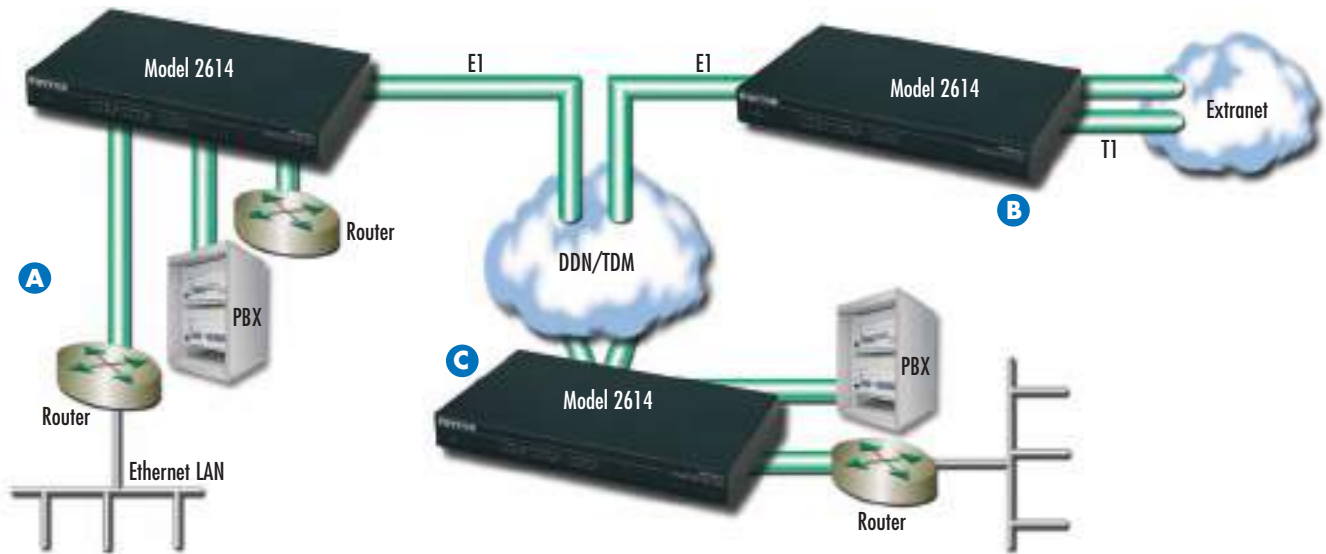

A T1/E1 Aggregation. Medium-size enterprises can aggregate and groom time slots from up to three partially used local T1/E1 lines onto a single outgoing link. This capability enables routers, PBXs, and other network devices dispersed over the campus area to efficiently use a single T1/E1 line for network access.

B T1/E1 Conversion. In situations where T1 and E1 networks converge, ports on the Model 2614 can be configured as E1 or T1 interfaces. This feature provides the capability for mapping and transparently transport T1 64 kbps time slots over E1 lines, and up to 24 E1 channels per T1 line.

C Wide Area Deployment—Local Switching. In a wide area deployment, medium- and large-size enterprises can use the Model 2614 for local timeslot switching from multiple local or remote T1/E1 lines. The model 2614 HTTP/SNMP flexible management allows provisioning and monitoring of switching sites from any remote or central location.

SPECIFICATIONS

WAN ports: Four software configurable channelized ports. E1 — G.703/G.704 with HDB3 and AMI encoding support. T1 — ANSI T1.403 & AT&T TR54016 with AMI coding/D4 framing or 8B2S coding/ESF framing. Configurable T1 line build-outs
Ethernet Ports: Two port 10/100/1000BaseT (RJ-45 connector); auto-negotiating; half or full duplex operation with built-in MDI-X

Management: HTTP/SNMP, Telnet/SSH Ethernet, RS-232 Console Port, SYSLOG Client, Software upgrade via TFTP
Protocols: IP (RFC 741), TCP (RFC 793), UDP (RFC 768), ICMP (RFC 950), ARP (RFC 826), PPP/BCP, PPP/PCP; Supports sending IP management traffic via IEEE 802.1p/Q Ethernet links.
Security: Logging of session, Password protected system management

with a username/password for console and virtual terminal.
Power Supplies: Internal universal 100–240 VAC input (50/60 Hz). Less 15W power consumption.
Compliance: EMC Compliance: EB56022 and EN55024
Safety Compliance: EN 60950
FCC Part 15A, CE Mark, FCC part 68, CS-03

Environment:
Operating temperature: 32–122 °F (0–50 °C)
Humidity: up to 90% non-condensing
Dimensions:
11 x 1.5 x 7 in. (280 x 39 x 180 mm)



I'm Bob, one of Patton's Support Engineers. If you do not find what you need at www.patton.com or in this catalog, or if you have technical questions or comments, please call me at +1 301.975.1007. You can also send e-mail to puckett@patton.com.

ORDERING INFORMATION

- 2614/U/R48: 4-Port, T1/E1 DACS Redundant -48 VDC Power
- 2614/U/RUI: 4-Port, T1/E1 DACS Redundant 120–220 VAC Power

16-Port DACs

Model 2616 Digital Cross Connect Unit

The most flexible T1/E1 cross connection and aggregation solution in Telco and ISP deployments



The Model 2616 is the answer for high density T1/E1 digital cross connection needs in telco, ISP, and enterprise environments. Allowing flexible any-to-any DSO mapping, the Model 2616 comes with 16 T1/E1 user programmable ports in a 1U high, 19-in. chassis.

Using a robust hardware platform and a rich set of software features—including an intuitive graphical SNMP/HTTP user interface—the Model 2616 can be used in applications ranging from simple non-blocking cross connection; to DSO aggregation and grooming in mobile telephony; to transport of T1 over E1 lines, or vice versa.

When network growth includes the use of multiple T1 or E1 lines, Model 2608 DACs are the ideal tools for managing and maximizing the allocation of 64 kbps channels in under-utilized lines, reducing the cost per channel and freeing

bandwidth for further growth. ISPs, telcos and Enterprise customers can concentrate data and voice services from local sub T1 and E1 lines onto fully utilized local-loop uplink connections with complete freedom and ease of use.

The Model 2616 features an RS-232 and a 10/100Base-T port configuration. The RS-232 port provides access to VT-100 configuration menus, while the 10/100Base-T port allows remote configuration and monitoring via Internet connection from any location in the world. For remote configuration the Model 2608 comes with a built-in web server, which provides intuitive drop down menus for simple configuration testing and monitoring. For complete flexibility, The Model 2608 can also be managed using any standard SNMP software tool.

FEATURES & BENEFITS

- ✓ 16 T1/E1 ports—switch up to 240 64-kbps channels
- ✓ DACs, multiplexer, or T1/E1 converter—all in one box.
- ✓ SNMP/HTTP Management
- ✓ Complete local and remote alarm facilities
- ✓ Full suite of T1/E1 diagnostics
- ✓ Standard reach of 1.6 km on any T1/E1 port
- ✓ Compact 1U chassis
- ✓ Convection cooled design with no fans or other moving parts supports chassis stacking
- ✓ AC/DC dual-redundant power supplies

Twisted pair connections provide standard T1 and E1 interfaces to network and local lines, while compact RS-232 Console and 10/100Base-T ports allow complete command and control of local and remote units. Dual redundant power supplies, with choices of DC or AC inputs, assure uninterrupted operation and service. Front panel LEDs provide at-a-glance status of system and network signals, while a comprehensive set of diagnostics features and alarms enable network personnel to quickly isolate failures and minimize down time.

The Model 2616 DACs is fully compatible with Patton DSL, T1/E1 NTUs, fiber optics T1/E1 multiplexers, and network extenders—thereby providing a global solution to enterprise customers in wide area network deployments.

SPECIFICATIONS

T1/E1 Ports: 16 T1/E1 ports: E1 (HDB3/AMI line coding), T1 (AMI/B8ZS line coding)

Ethernet Port: 1 10/100Base-T (RJ-45 connector)

Clocking: Internal, Network (from T1/E1 WAN port), External BITS (Building Integrated Timing Supply) Clock Source via 3-pin terminal block

Front Panel Indicators: LEDs for power, CPU, system, Ethernet, External clock, test mode, and WAN ports frame and error status

Power Supplies: Dual-redundant universal AC/DC (fixed); AC power: 90–264VAC (50/60 Hz); DC power: -36 to -72VDC

Management Services: HTTP, SNMP, TELNET Ethernet, RS-232 Console

Port, SYSLOG Client, Remote Software Upgrade via FTP

Alarm Reporting: Configurable alarms; Remote SNMP Traps; Front Panel LEDs; 3-Contact Relay for local alarm (3-pin terminal block)

Compliance: Safety: UL/CSA per UL1950 (METS) Canadian cMET and CS-03. EMC Directive 89/336/EEC, Low-Voltage

Directive 73/23/EEC (EN 60950), FCC Part 15, CE Mark, CTR12, CTR13, FCC Part 68.

Op. temp.: 0–40°C (32–104°F); **Humidity:** 5–90% non-condensing

Dimensions: 48.25 W x 32.00 D x 4.44 H cm (19.00 W x 12.60 D x 1.75 H in.)



I'm Brian, one of Patton's Product Validation Engineers who makes sure your DACs product works reliably. To buy one of these state-of-the-art devices, call +1 301.975.1000 or send e-mail to sales@patton.com.

Frame Relay application



Frame Relay continues to be the technology of choice for branch office and high speed Internet Access. Most users will access this service over partially used T1/E1 lines. Before these lines are connected to Frame Relay switches at Central Offices, a Model 2616RC can groom data carrying

channels into fewer number of fully utilized T1/E1 lines. Now an FR switch can economically and efficiently connect many more users to the FR services.

T1/E1 Concentration

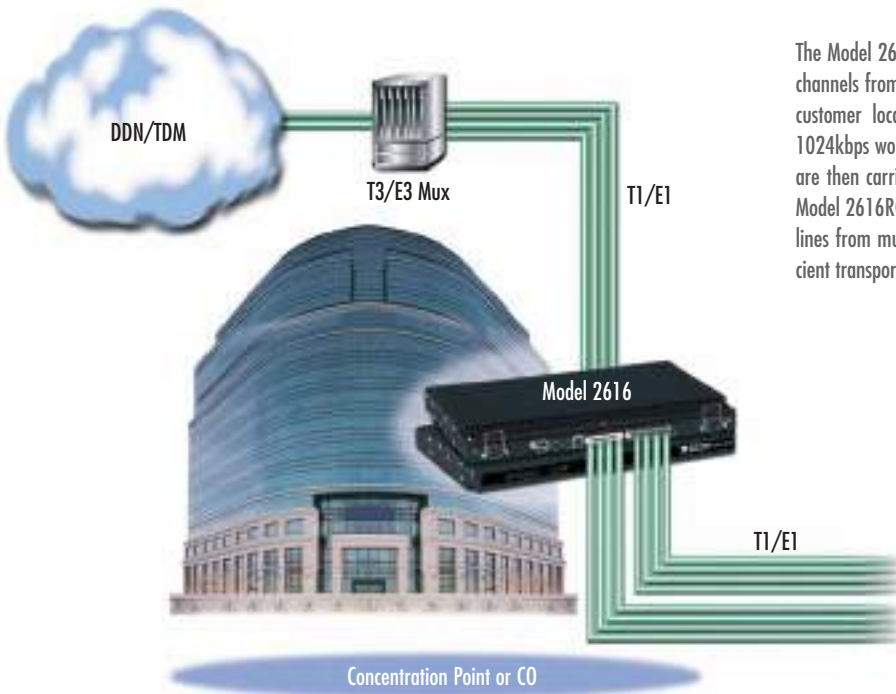

The Model 2616RC high density DACs can concentrate and groom Nx56/nx64kbps channels from T1/E1 lines deployed from an aggregation point or Central Office to customer locations. In many instances, customers lease 256kbps, 512kbps, or 1024kbps worth of bandwidth resulting in lines carrying many idle channels, which are then carried inefficiently by T3/E3 multiplexers across the network. Using the Model 2616RC, telcos can groom and aggregate channels from partially used T1/E1 lines from multiple customer sites onto network bound, fully utilized lines for efficient transport by fiber or T3/E3 multiplexers.



I'm Scott, Patton's Vice President of Product Management. If you do not find the answers you need at www.patton.com, please call me at +1 (301) 975-1000 x166. You can also send e-mail to scott@patton.com.

The Model 2616 can efficiently concentrate and groom Nx56/nx64kbps channels from T1/E1 lines deployed from a small to medium concentration point or Central Office (CO) to customer locations. In many instances, customers do not lease all channels in a T1 or E1 line. For example, they will lease 256kbps, 512kbps, or 1024kbps worth of bandwidth, leaving T1/E1 lines with many idle channels. At the concentration point, carriers may just feed these lines (including idle channels) onto T3/E3 Multiplexers, for transport over the carrier's network, this is simply inefficient. Using the Model 2616, telcos can groom and aggregate partially used T1/E1 lines from multiple customer sites onto network bound, fully utilized lines for economical transport over fiber or T3/E3 trunks. The model 2688 is equipped with dual redundant power supplies, fail over T1/E1 features, and local and remote alarms to give you peace of mind while deploying it in your most critical nodes.

ORDERING INFORMATION

16-port DACs

2616/B/RUI: Black Ice chassis, Dual AC supplies

2616/B/R48: Black Ice chassis, Dual DC supplies

visit us online
www.patton.com

FAST Delivery From Your AUTHORIZED DISTRIBUTOR!



High Density Rack System for Universal Access

Model 1001 Telco Rack System

The Model 1001MC supports a variety of last-mile devices in a 2U-high, 19-inch wide rack-mount chassis with redundant AC/DC power supplies.



The Model 1001 high-density rack system supports a variety of last-mile devices in a 2U-high, 19-inch wide rackmount chassis with redundant AC/DC power supplies.

When users require higher density solutions, a rack system becomes more economical. The NetLink Model 1001 rack system consists of a 2U-high chassis that can be mounted in any standard 19-inch wide telco rack. The Model 1001 chassis supports up to 16 modem modules and a single AC or DC power supply, or dual-redundant AC or DC power supplies.

The rack shown below is a fully-configured NetLink Model 1001 rack system containing 13 modems, a network

management module, and two power supply modules that fill the 18 front rack slots. Equipment/network interface modules that fill the rear slots of the rack chassis connect to the front modules through a midplane bus that extends the width of the rack.

Nearly all of the electrical and physical interfaces—from Ethernet to V.35—are available as I/O modules. Dual redundant AC or DC power supplies can be installed in the rack system to help avoid catastrophic failures caused by power fluctuations or outages.

FEATURES & BENEFITS

- ✓ High-density rack system supports up to 16 modems in a 2U-high, 19-inch wide rack-mount chassis with integral AC/DC power supply
- ✓ Configurable input/output modules support all serial, voice/fax, Ethernet and G.703 DTE interfaces.
- ✓ The NetLink rack system can expand to 320 modems in a standard 40U-high rack system.
- ✓ Integrated SNMP and HTTP management system
- ✓ Automatic load-sharing, dual-redundant AC and DC power supplies
- ✓ Manage up to Eight Racks through a signal 1001MC SNMP management card
- ✓ Choose the technology you need
 - IDSL • E1/G.703 • mDSL • T1/FT1
 - VDSL • Baseband • E1/FE1 • Ethernet

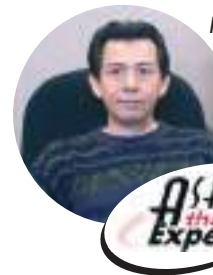

I'm Jose, Patton's Technical Solutions Manager for Latin America. If you have any questions about products or applications using these technologies, please call me at +1 301.975.1000, x142, or send e-mail to jose@patton.com.



Technology	Modem Rack Card Model	Description	CPE Model (Standalone)	Page	
xDSL	iDSL	1092ARC	64/128 kbps; 2/4 wire iDSL modem	1092ARC	93
	G.SHDSL	3088RC	192 kbps—4.6 Mbps; 2 wire	3088	82
	VDSL	1058RC	12.5 Mbps, 2-wire VDSL modem	1058	93
		1068RC	16 Mbps, 2-wire variable rate modem	1068 • 1058	90 • 90
E1/Frac. E1	2701RC	nx64 kbps up to 2.048 Mbps G.703 NTU	2715 • 2701	107 • 102	
E1/G.703	2703RC	2.048 Mbps G.703 NTU	2703	105	
T1/Frac. T1	2710RC	1.544 Mbps/nx56/64 kbps CSU/DSU	2710	100	
Baseband	1092RC	64/128 kbps; 2-wire baseband modem	1092	93	
Ethernet	2168RC	16 Mbps, 2-wire multi-rate Ethernet extender	2158 • 2168	57 • 56	
	2158RC	12 Mbps, 2-wire Ethernet extender	2158	57	
	2157RC	4.6 Mbps, 2-wire Ethernet extender	2157	58	
	2156RC	2.3 Mbps, 2-wire Ethernet extender	2156	58	
	2155RC	128 kbps, 2-wire Ethernet extender	2155	59	

Network Management via SNMP or HTTP

The NetLink rack system enables users to configure, control, and perform diagnostics via SNMP or HTTP. To manage a rack system, the operator need only install a NetLink Management Module (Model 1001MC), connect a workstation to its Ethernet port, and launch a standard Web browser (i.e., Netscape Navigator or Internet Explorer). Now, any operator can manage any NetLink rack card or standalone modems from a local PC or via the Internet.

Dual-Redundant AC and DC Power Supplies

The Model 1001 rack system can have one or two 90–264 VAC or -12/-24/-48 VDC power supplies installed in any com-

ination. Each power supply can support a fully-loaded rack configured with any combination of front modem modules and rear I/O cards. If two power supplies are installed, they automatically self-configure for dual-redundant, load-sharing operation. In that configuration, each power supply shares 50% of the load.

In the unlikely event of a supply failure, the other supply begins providing 100% of required power; the operator is notified by an audible alarm; an LED flashes on the front panel; and the central site operator is notified via the network management system.

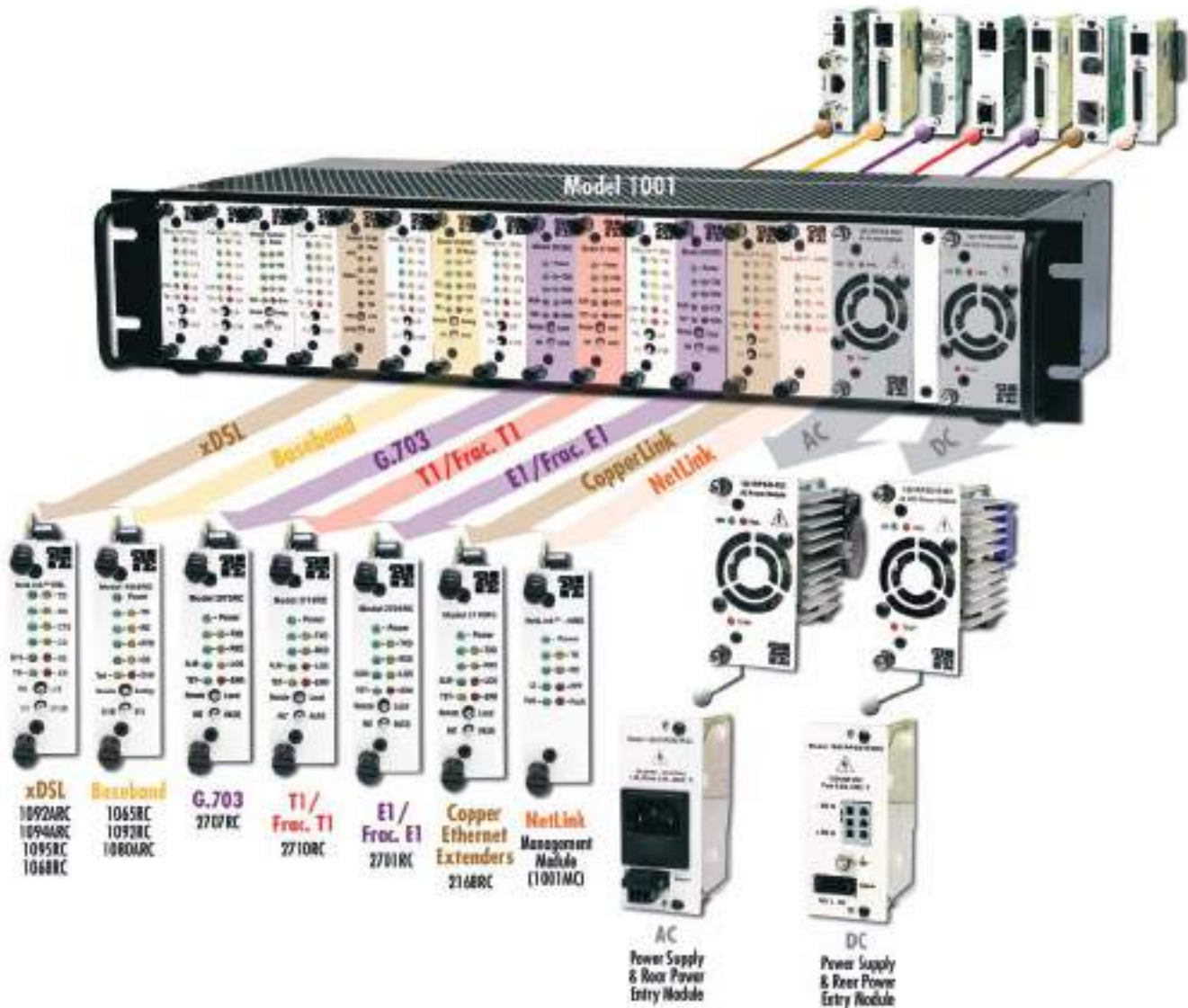

High Density Rack System for Universal Access (continued)

Model 1001 Telco Rack System

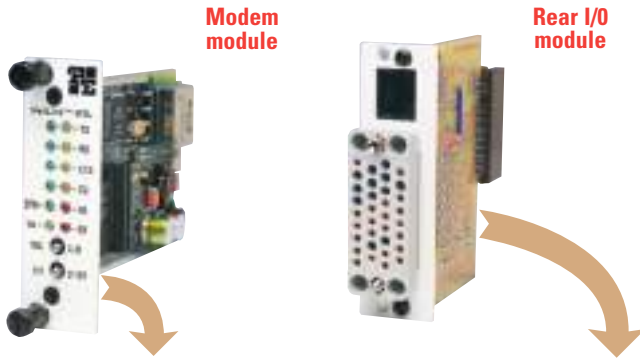

Great Modularity & Interface Functionality

The NetLink rack system's midplane bus connects front modem modules and rear I/O modules, delivering the right combination of modem technology and interface support. Physical/electrical interface conversion is also built-in to the system architecture. For example rack cards with G.703/G.704 interfaces will connect to V.35/X.21/EN standalone units.

Technology	Model	Description	Rear Rack I/O Cards
xDSL	1092ARC	iDSL—2W/4W	
	3088 RC	G.SHDSL— 2W	
	1058RC	VDSL— 2W	
	1068RC	VDSL— 2W (Variable rate)	
Baseband T1 CSU/DSU	1092RC	2W Modem	
	2710RC	T1/FT1	
	2701RC	G.703/G.704	
G.703/2 Mbps Converter	2703RC	E1/G.703	
	2707RC	E1/G.703	
Copper Extenders	2168RC	16.67 Mbps Multi-Rate	
	2158RC	12.5 Mbps	
	2157RC	4.6 Mbps	
	2156RC	2.3 Mbps	
	2155RC	144 kbps	

Three Kinds of CPE



Compatible CPE	Compatible CPE Model	Page
B	1092A • 1082	95 • 96
C	3088 Standalone	84
B	3086	86
C	1058 • 1068	91 • 92
C	2710	102
B	2073	111
A	2715 • 2701	109 • 104
C	2703	107
C	2707	108
C	2158 • 2168	59 • 58
C	2158 • 2168	59 • 58
C	2157	60
C	2156	60
C	2155	61

SPECIFICATIONS

19-in. Rack Mountable Chassis
Temp.: 32–122°F (0–50°C)
Humidity: 5–90% non-condensing

1001MC Management Card
Management: SNMP/HTTP—SNMP Version 1, Enterprise MIB
FTP Update Support: Integrated FTP server to receive new code images
Interface: 10Base-T Ethernet via RJ-45 Terminal Interface via RS-232 DTE:

19200 bps Async, 1 stop bit, 8 data bits, and 0 parity
LED indicators: Power, Transmit/Receive, Ethernet, PPP, Poll, Fault
Multi Chassis: Up to 8 chassis Daisy-chained via 1001CC
48 VDC Power
Input Voltage: 42–60 VDC
Input Current: 2.2A nominal
Surge Protection: to 75 VDC
LED indicators: Normal, Power Failure, Over Temperature
Weight: 0.7 lbs (0.32 kg)

AC Power
Input Voltage: 90–264 VAC
Input Frequency: 50/60Hz
Input Current: 1.8 A RMS
Surge Protection: to 300 VAC
LED indicators: Normal, Power Failure, Over Temperature
Weight: 0.7 lbs (0.32 kg)
Approvals: NRTL US UL/1950, CAN CSA/950, EN60950, CE Listing, FCC Part 15 Class A

ORDERING INFORMATION

- 1001R16P/48V: 16-slot Model 1001 rack; one -48 VDC power supply & rear power entry module (RPEM)
- 1001R16P/UI: 16-slot Model 1001 rack; one 90–260 VAC power supply & RPEM with an IEC-320 connector.
- 1001R14P/R48V: 14-slot 1001 rack; two -48 VDC power supplies operating in a load-sharing, dual-redundant mode.
- 1001R14P/RUI: 14-slot 1001 rack; two 90–260 VAC power supplies & RPEMs operating in a load-sharing, dual-redundant mode.
- 1001R14P/RUI48: 14-slot 1001 rack; one -48VDC & one 90–260 VAC power supply, one AC and one DC RPEM operating in a load-sharing, dual-redundant mode.
- 1001R: 16-slot 1001 rack with midplane bus.
- 1001RPSM-RUI: 90–264 VAC power supply.
- 1001RPEM-RAC: Rear power entry module (RPEM) with IEC-320 connector.
- 1001RPSM-R48V: -48 VDC power supply.
- 1001RPEM-RVDC: Rear power entry module (RPEM) for DC power source.
- 1001MC: SNMP/HTTP management module (requires one slot)
- 1001CC: Control module for daisy-chaining additional racks

10 and 2-Slot Universal Mounting Panels

Models 1001MP10 & 1001MP2

Rack, stack, and organize up to 10 Patton devices with these multi-functional mounting panels.

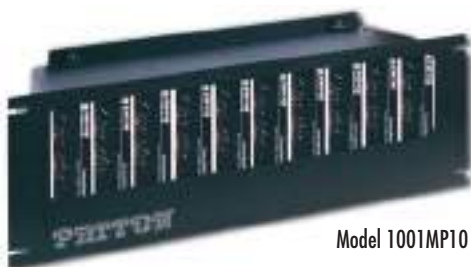

Model 1001MP10

The Model 1001MP10 Universal Mounting Panel offers the ability to rack up to 10 Patton products side by side. Products that are compatible with the 1001MP10 and 1001MP2 include Ethernet Extenders, xDSL modems, short range modems, NTUs, and much more!



Model 1001MP2

The Model 1001MP10's sturdy 4U design easily installs into any standard 19-inch rack. A combination of a unique groove system and an easily installed back panel enables the 1001MP10 to securely lock the individual Patton modems and their power supplies. For lower density applications, the Model 1001MP2 offers a 1.5U-high, 2-slot panel.



1001MP10 rear view

10 rear slots for device power supplies

The Model 1001MP series offers a convenient method for converting your favorite Patton standalone product into a rack-mounted solution.

FEATURES & BENEFITS

- ✓ **Multi-Functionality**—Supports NTUs, xDSL Modems, Short Range Modems, and Ethernet Extenders.
- ✓ **Independent Slots**—Up to 10 independently operating slots to completely do away with any single point of failures.
- ✓ **Rackmount**—Both Universal Mounting Panels fit into any 19-in. rack. The 10-slot panel is only 4U (7 in./17.78 cm) high. The 2-slot is 1.5U (2.63 in./6.68 cm) high.
- ✓ **Cost-Effective**—Rack-mount products you have already purchased.



I'm John, one of Patton's Micro-Products Group Managers. If you do not find what you need at

www.patton.com or in this catalog, please call me at +1 301.975.1000, x160. You can also send e-mail to igrant@patton.com.



Patton Product Compatibility Table

xDSL Modems	E1/T1 Network Extenders	E1/T1 NTU	Ethernet Extenders	Serial Short-Range Modems
1082: iDSL Modem	2113: T-Link E1 Extender	2701 Series: G.703/G.704 FE1/E1 NTU	2155: 144 kbps CopperLink Extender	1060: RS-232 115.2 kbps Asynchronous SRM
3088: G.SHDSL Modem	2115: T-Link T1 Extender	2707 Series: G.703 Clear Channel E1 NTU	2156: 2.3 Mbps CopperLink Extender	1070: RS-232 19.2 kbps Synchronous SRM
3201: 2.3 Mbps G.SHDSL Router		2720 Series: T1/FT1 NTU	2157: 4.6 Mbps CopperLink Extender	1080A: RS-232 57.6 kbps Async/Sync SRM
3241: 4.6 Mbps G.SHDSL Router			2158: 10 Mbps CopperLink Extender	1080A-64: RS-232 64 kbps Async/Sync SRM
1068: VDSL Modem			2168: 16 Mbps CopperLink Extender	1226: Parallel 115.2 kbps SRM
			2172: 50 Mbps CopperLink Extender	1075: X.21 64 kbps Sync SRM
				1226: RS-232 38.4 kbps Async SRM

SPECIFICATIONS

1001MP10

Front Panel: 10 independently operating slots

Dimensions: 19 L x 6.75 W x 7 H in. (48.3 L x 17.15 W x 17.78 H cm)

Weight: 4.15 lbs (1.90 kg)

1001MP2

Front Panel: 2 independently operating slots

Dimensions: 19.0 W x 2.63 H x 1.9 D in. (48.3 W x 6.68 H x 4.8 D cm)

Weight: 2 lbs (0.95 kg)

ORDERING INFORMATION

1001MP2: 19-in. Horizontal 2-Slot Rack

1001MP10: 19-in. Vertical 10-Slot Rack

16-Slot Universal Mounting Panel

Model 1001MP16

Rack, stack, and organize with Patton's Multi-Functional Universal Mounting Panel. Rack up to 16 Patton MicroPak Devices into a dense 2U solution.



Rack-Mount any of Patton's MicroPak Products

FEATURES & BENEFITS

- ✓ Mount any MicroPak—Supports media converters, terminal servers, Ethernet bridges, fiber modems, CSU/DSUs, interface converters, short haul modems, and surge protectors
- ✓ Low Profile-2U High—Universal Mounting Panel is only 2U (3.5 in. or 8.9 cm) high and holds up to 16 MicroPaks; Installs quickly into any standard 19 inch rack
- ✓ Dry-erase label blocks and port identification numbers for easy circuit identification
- ✓ Cost Effective—Adapt Patton MicroPak products you already own for use in a standard 19 inch rack, thereby eliminating the expense of upgrading to rack-mounted equipment

The Model 1001MP16 Universal Mounting Panel offers the ability to rack-mount any of Patton's MicroPak products side-by-side. Products that are compatible with the 1001MP16 include Device servers, Media converters, Ethernet bridges, Fiber modems, Interface converters, and many more!



The sturdy 2U design of the 1001MP16 enables quick and hassle-free installation into any standard 19-inch rack. The 1001MP16's unique bracket-and-groove mounting system enables Patton MicroPak cases to be mounted securely into the panel. Dry-erase labels and individually numbered ports are provided for easy circuit/port identification.

The Model 1001MP16 provides an economical method for converting your favorite Patton standalone MicroPak products into a customized rack-mounted solution.



Back View

Unique bracket-and-groove system fastens the MicroPak securely into the panel

Patton Product Compatibility Table

VoIP Micro-ATAs & AFAs		Device Servers		Serial Modems		Surge Protectors	
M-ATA	M-AFA	2120 Series	2120/A9	1000R Series	1012AR Series	503PC	570 Series
				1007 Series	1017 Series	534 Series	580 Series
				1010R Series	1052 Series	547 Series	552 Series
Serial/Parallel Converters		Ethernet Bridges		Data Taps		Interface Converters	
2026P	2036P	2121 Series	2135C Series	3/11	3/45	2016 Series	2070 Series
		2124 Series	2135 Series			2021 Series	2702 Series
		2130 Series				2040 Series	2090 Series
						2041 Series	2094 Series
Baluns		CSU/DSUs		Modem Eliminators		2042 Series	
460 Series	470 Series	2710 Series	2715 Series	1205 Series	1206		
462 Series	471 Series	2711 Series	2400 Series				
463 Series	472 Series						
465 Series							

and many more...

SPECIFICATIONS

Front panel: 16 Operationally independent slots
Dimensions: 19L x 1.5W x 3.8H in. (48.3L x 3.8W x 8.9H cm)
Weight: 1.1 lbs (0.5 kg)

Latching: 16 individual steel clips with hardware (Included with unit)
Power: None required. Some units may require individual power supplies

ORDERING INFORMATION

1001MP16: 19-inch, 16-Slot Mounting Panel
1001MP-PS8: 8-Barrel 5V, 4A Power Supply

Connectivity

Ethernet & Audio/Video Extenders

- Enables Ethernet to operate over existing standard phone-grade twisted-pair
- Extends Ethernet up to 5 miles (8 km)
- Line rates up to full-duplex 50 Mbps
- Extends IP network cameras



Pg 56-65

Line Drivers

- Extend RS-232 over twisted pair, coax or fiber
- Multi-point and point-to-point
- Optical isolation and surge protection available
- Sync/async

CCTV/CATV & G.703/G.704 EI Baluns

- Control, collect, and monitor information from any RS-232, RS-422, or RS-485 device
- Provide secure encrypted connection between your serial devices and IP network
- 1, 4, and 8-port options available



Pg 188-199

Interface Converters

- Converters for RS-232, RS-422/RS-485, TTL, current loop, serial/parallel (printer) and Ethernet
- No power required
- Surge protection available on some models
- WAN interfaces include X.21, V.35, G.703/G.704, and HSSI

Hardened Networking

- Environmentally sealed and thermally controlled network equipment
- NEMA 4 rated enclosures with -40 to 85°C operating and starting temperatures
- Serial, T1/E1, VoIP, and Ethernet models available



Pg 144-147

Adapters & Testers

- Data taps, line monitors, gender changers, and null modems
- Prewired or customized RJ-45, RJ-11, DB-25, DB-9, and more adapter kits available

Extending, Converting & Converging



Pg 200-217

Optical Isolators & Surge Protectors

- Surge protection for RS-232, 422/485, Ethernet, parallel, dial up, leased line, V.35, and X.21
- Optical isolation for RS-232, 422/485



Pg 230-239



Pg 170-187

Device Servers

- Eliminates the use of expensive coax and extends signal over twisted pair
- No power required
- Completely passive



Pg 148-155



Pg 240-244

Multiplexers & Sharing Devices

- Allows multiple low speed serial devices to share one communication link
- Configure and control multiple devices with web based management, SNMP or CLI



Pg 218-229

Industrial Ethernet with Patton

Ethernet is no longer a stranger to the Industrial Community. Ethernet's low cost, reliability, flexibility, and ease to migrate to more bandwidth intensive applications makes it a clear choice over traditional serial communications. Patton Electronics offers a wide variety of products to meet these Industrial Ethernet requirements. Patton's product line includes Device Servers, Ethernet LAN drivers, Wireless Networking, Ethernet/PoE Ethernet Surge Protectors, and a full range of NEMA4 and extended temperature products.

- ✓ **EtherBITS Device Servers**— Control, Monitor, and Collect RS-232/422/485 over an Ethernet LAN
- ✓ **CopperLink™ Ethernet LAN Drivers**— Extends Ethernet over standard grade twist-pair over its 328 ft (100m) limitation at line rates as high as 50 Mbps.
- ✓ **Wireless Networking**— Extend RS-232 serial devices over Bluetooth, or control, monitor, and collect RS-232 data over 802.11b WiFi.
- ✓ **LAN Protectors**— Protects valuable Ethernet and PoE Ethernet Device from Surges
- ✓ **EnviroNET™**— Ethernet extenders, Device Servers, Multiplexors, T1/E1 extenders, VoIP Gateways and Routers all meeting NEMA4 (IP65) and -40 to 85°C specifications.

802.11b Wireless

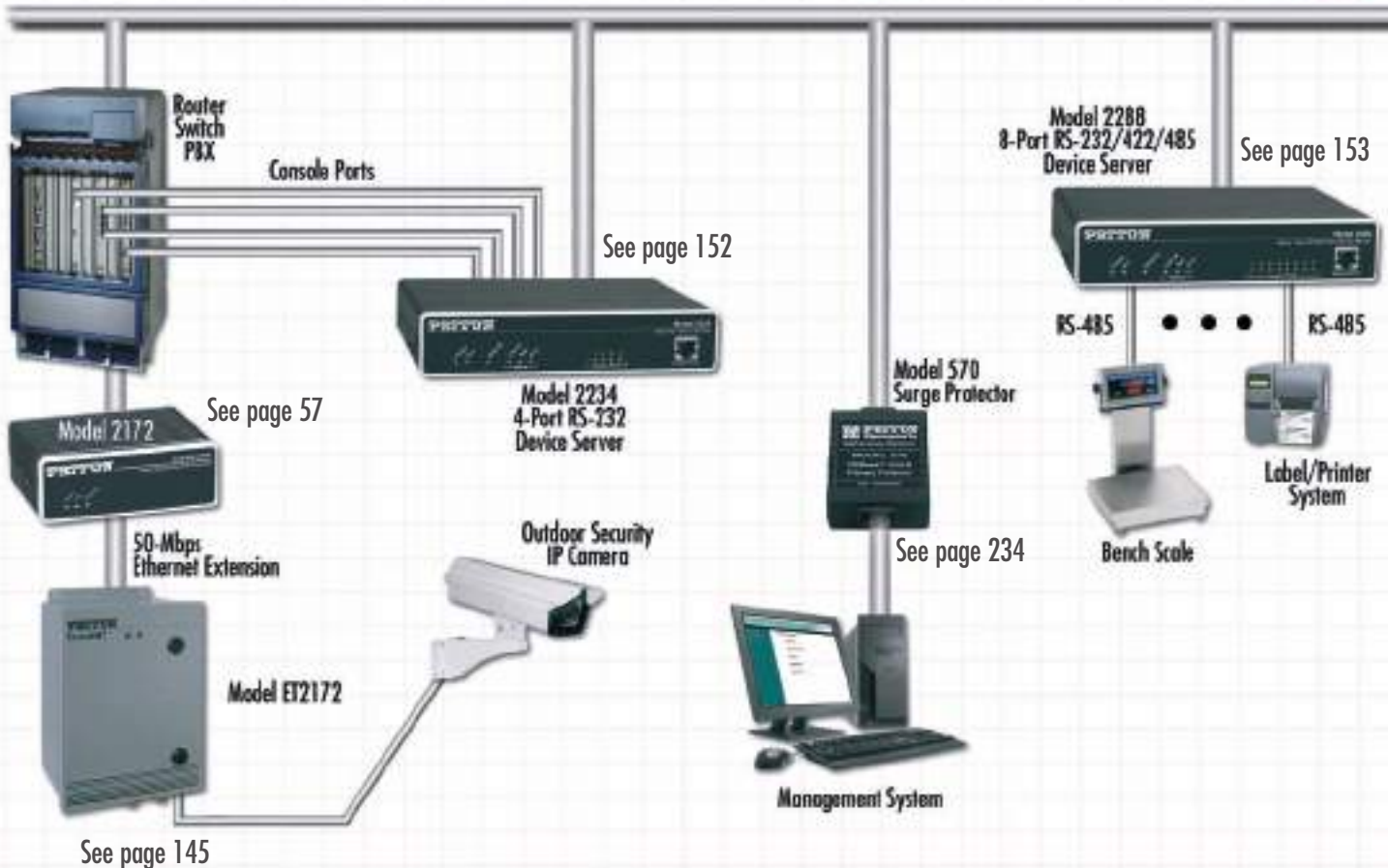

Link-Up for Less

Bluetooth

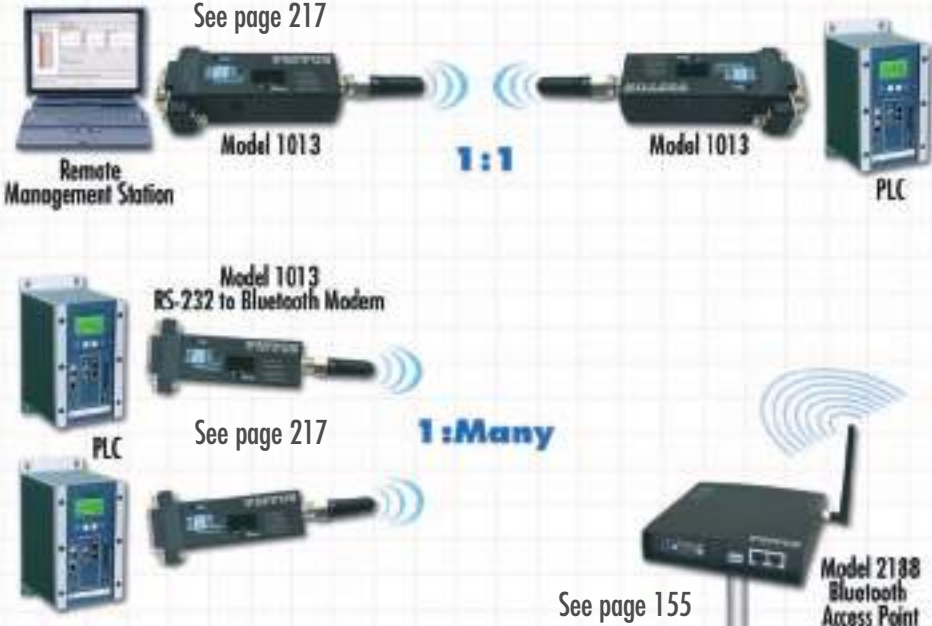

In This Section

EnviroNET™ Solutions	144
Nano Industrial Computers	146
NanoServ™ Industrial PC	146
Device Servers	148
Single-Port Terminal Server	148
RS-232 Device Server	149
RS-485/422/232 Universal Device Server	150
Wireless (802.11b) Device Server	151
Multi-Port Asynchronous RS-232 Device Servers	152
Async. over IP Multi-Port Device Servers	153
Leased-Line Extender over IP	154
Bluetooth IP Access Point	155

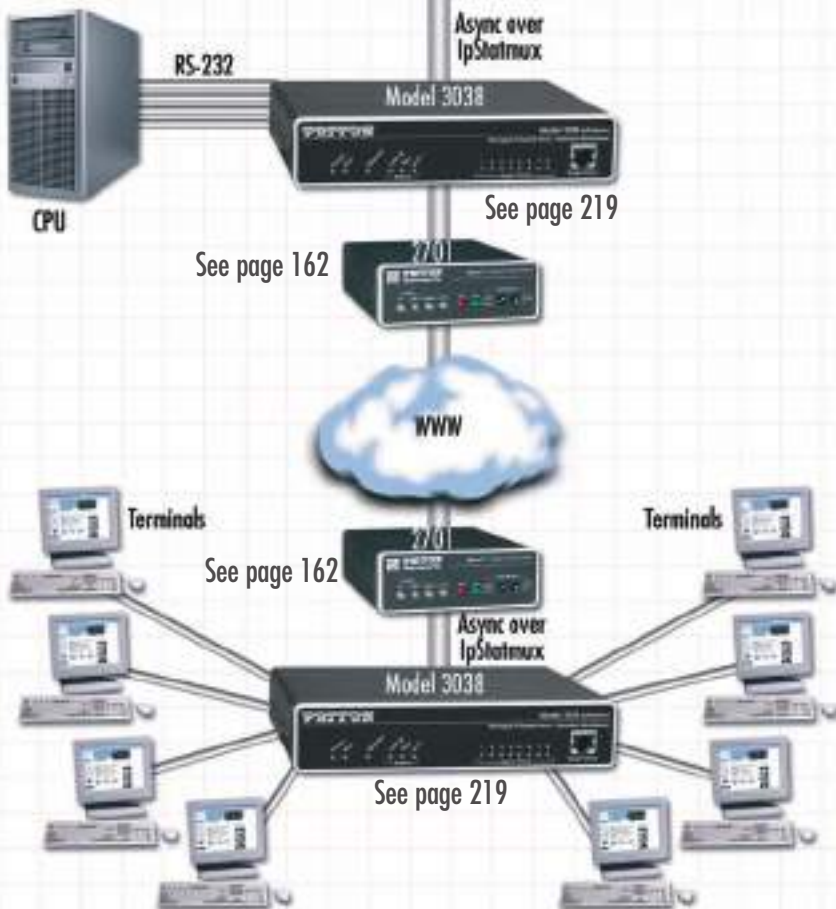

EnviroNET™ Solutions



EnviroNET™ EH Series Environmentally Hardened

Built to NEMA 4 specs, the durable EH Series protects against rain, sleet, snow, dirt, dust, ice build-up, high humidity (moisture) and physical tampering. Designed to operate in temperatures ranging from 32 to 122°F (0 to 50°C), it is ideal for use in environments that provide controlled temperatures.



EnviroNET™ EC Series Environmentally Controlled

The EC Series offers the same protection from environmental elements as the EH Series, plus it has a temperature control system enabling it to operate in temperatures ranging from 32 to 185°F (0 to 85°C).



EnviroNET™ ET Series Extended Temperature

In addition to providing the same protection from environmental elements as the EH Series, the advanced ET Series temperature control system enables it to operate in temperature extremes of -40 to 185°F (-40 to 85°C). Potential installation locations and applications for the ET Series are virtually limitless!

Ethernet Extension

Extensive range of environmentally hardened and extended temperature solutions for extending Ethernet connections at distances up to 5 miles (8 km) over phone-grade twisted-pair!

The Patton EnviroNET™ Ethernet Extender offers a reliable and robust solution for connecting peered 10/100Base-T Ethernet LANs; reaching remote PCs and equipment; or delivering last-mile ISP services—at line rates up to 50 Mbps! Patton's EnviroNET allows the Ethernet Extenders to operate under harsh tempera-

tures of -40 to 185°F (-40 to 85°C) and resist various environmental elements such as dust, rain, snow, sleet, etc. Just co-locate an EnviroNET Ethernet Extender at any outdoor data acquisition location and pair it up with an equivalent Patton Ethernet Extender inside the building.



T1/E1 Transport Extension

EnviroNET™ Extended Temperature T1/E1 Transport Extenders make it easy to terminate a T1/E1 in a remote, environmentally exposed location.

Overcome line of sight T1/E1 distance limitations and add flexibility to your wireless T1/E1 network topology with the EnviroNET T1/E1 Transport Extenders. Just co-locate an EnviroNET T1/E1 Transport

Extender at the Outdoor Cabinet (ODC) and a Patton Model 3088/K or T unit at the Customer Demarc to extend the reach of the T1/E1 wireless circuit at distances up to 5.3 miles (8.5 km).

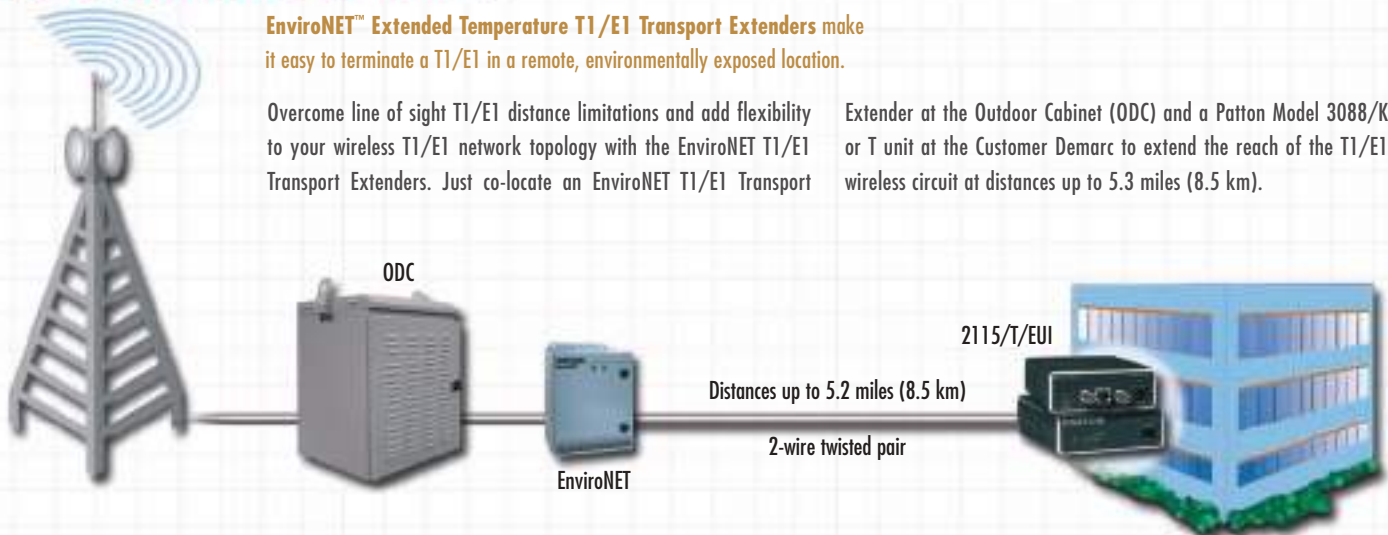

Ethernet Anywhere

EnviroNET™ Hardened Networking Products Deliver...
Voice, Video and Data Communications Services...
In ANY environment.

Voice-over-IP Gateways

EnviroNET™ Voice-over-IP Gateways provide a reliable, robust, and secure solution for converting your Analog FXS/FXO or Digital ISDN circuits to VoIP in harsh environments.

Extending Patton's EnviroNET Voice-over-IP Gateway routers into exposed environments for seamless access between remote packet-voice and local PSTN telephony. Using ToIP call switching, distinctive ring, and Caller-ID a single handset can now access the right service at any time. With Patton's

ClearConnect™ fail-over protection, a phone call will be completed. Network health monitoring and ToIP switching ensures a clear call even if the IP network is down. Patton's EnviroNET protective enclosures give service providers unlimited installation locations.



SPECIFICATIONS

General Product Specifications for ET Extended Temperature Product

Operating Temperature: -40 to 185° F (-40 to 85°C)
Dimensions: 8.0 L x 4.5 W x 11.5 H in. (203 L x 114 W x 292 H mm)
Weight: 8.5 lbs (3.86 kg)

General Product Specifications EN Environmentally Enhanced Product

Operating Temperature: 32 to 122°F (0 to 50°C)
Dimensions: 8.0 L x 4.5 W x 11.5 H in. (203 L x 114 W x 292 H mm)
Weight: 8.5 lbs (3.86 kg)

ORDERING INFORMATION

Extended Temperature Ethernet Extender

- ET2172/EUI: Multi Rate 50 Mbps
- ET2168/EUI: Multi Rate 16 Mbps
- ET2157/EUI: Rate Adaptive 4.6 Mbps
- ET2156/EUI: Rate Adaptive 2.3 Mbps
- ET2155/EUI: Long Range 144 kbps

Extended Temperature Device Servers

- ET2232/EUI: RS-232 Device Server 10Base-T
- ET2211/EUI: RS-232 Device Server 802.11b
- ET2285/EUI: RS232/422/485 Device Server 10/100Base-TX

Extended Temperature T1/E1 Extenders & Converters

- ET2115/T/EUI: T1 Extender
- ET2113/K/EUI: E1 Extender

- ET2720/C/EUI: T1 to V.35 Converter/NTU
- ET2720/I/EUI: Ethernet Extender over T1
- ET2701/C/EUI: E1 to V.35 Converter/NTU
- ET2701/D/EUI: E1 to X.21 Converter/NTU

Extended Temperature xDSL Routers

- ET3087/RIK/EUI: 4.6 Mbps G.SHDSL V.35 Router
- ET3087/RID/EUI: 4.6 Mbps G.SHDSL X.21 Router
- ET3087/RIK/EUI: 4.6 Mbps G.SHDSL E1/T1 Router
- ET3201/R/EUI: 2.3 Mbps G.SHDSL Router
- ET3241/R/EUI: 4.6 Mbps G.SHDSL Router

Extended Temperature VoIP Gateways & Routers

- ET4524/JS/UI: 4 port FXS VoIP Router
- ET4524/JO/UI: 4 port FXO VoIP Router

- ET4528/4JS4JO/UI: 4 port FXS plus 4 port FXO VoIP Router
- ET4528/8JS/UI: 8 port FXS VoIP Router
- ET4552/2BIS/UI: 2 port BRI VoIP Router

Extended Temperature Serial Extenders

- ET1080A/UI: RS-232 Long Range Extender
- ET3088/D/UI: X.21 Serial Extender
- ET3088/C/UI: V.35 Serial Extender
- ET1052/UI: RS-232 High Speed Sync Extender
- ET1053/UI: RS-232 High Speed Async Extender

NanoServ Industrial PC

NanoServ™ Embedded Linux Family

Patton's NanoServ is a rugged, powerful, industrial-strength, embedded Linux server in an ultra-miniature package.



Model 6073—Diskless and fan-less

The NanoServ family of embedded Linux systems are available for specialized industrial and commercial applications, such as security, networking, and machine control. The NanoServ systems are available in a solid-state, diskless model or in a slightly larger model with a 40-Gbyte disk. Both models come with a rugged metal case suitable for the toughest environments. With no fans or other moving parts in the diskless system, the NanoServ requires no physical maintenance and has nothing to wear out over time.

The Patton NanoServ family provides the equivalent of 1.3 GHz of Pentium processing power based on the 800-MHz VIA Eden Nano CPU. The VIA processor includes support for hardware encryption that enables technologies such as advanced PGP (Pretty Good Privacy) public keys and AES

(Advanced Encryption Standard) encryption used in IPsec, enabling the creation of ultra-secure traffic flows between users. The encryption technologies will be useful in applications such as Virtual Private Networks (VPNs), corporate peer-to-peer LANs with restricted access for sensitive projects, and home wireless networks.



Applications can easily be developed to provide secure instant messaging, group chats, distributed presence, file browsing, file transfer, and support for multiple formats of ad hoc secure networking. The NanoServ family is designed to run local applications for specific vertical markets, plus allow access across a network to multi-user Linux servers.

The NanoServ comes pre-installed with a Fedora Core 5 Linux system* that fully boots in under 30 seconds. Fedora Core 5 is compatible with the vast majority of Linux applications and can automatically detect and auto-configure most x86-based hardware.

FEATURES & BENEFITS

- ✓ Compact—6.7 x 4.9 x 1.5 in. (17 x 12.4 x 5.8 cm)
- ✓ Powerful—800-MHz VIA processor equal to 1.3-GHz Pentium
- ✓ Heavy Duty Metal Case—Ready for the toughest environment but attractive enough for a desktop
- ✓ Fan-less—No moving parts; nothing to break; longer life
- ✓ Compatible—The NanoServ comes equipped with all the standard external I/O interfaces (serial, keyboard, mouse, USB, Line/out, Ethernet) found on ordinary PCs.
- ✓ Comes preloaded with Linux.



I'm Ken, one of Patton's Engineers designing the software for industrial computers. To buy one of these state-of-the-art devices, call +1 301.975.1000 or send e-mail to sales@patton.com.

NanoServ interfaces



Model 6075—Fan-less with 40-GB hard disk

ORDERING INFORMATION

6072/UI: Diskless NanoServ in a Thin Case

6073/UI: Diskless NanoServ in an Ultra-Thin Case

6074/UI: NanoServ with a 256MB Flash Drive in a Thin Case

6075/UI: NanoServ with a 40GB Hard Disk in a Thin Case

*Available with other Linux distributions. Call for availability.



**Model 2120
Terminal Server**

Today's Lesson Plan

- TCP
- UDP
- ICMP
- Telnet
- ARP
- DHCP
- FTP
- SLIP
- PPP
- IP NAT
- WINS
- DNS
- PAP

RS232 + 2120 = Ethernet

PPP + IP = Internet Access

Give your serial device an advanced degree in Ethernet

- ✓ Control and monitor any RS-232 terminal or devices over any IP/Ethernet LAN
- ✓ 802.3 Ethernet interface connects to any hub or switch
- ✓ RS-232 over IP
- ✓ Single Port RAS with any Modem
- ✓ User-selectable data rates up to 115.2 kbps
- ✓ Access your private network address through the internet



Single-Port Terminal Server

Model 2120

The versatile Patton Model 2120 brings RS-232 serial devices and control ports onto the LAN and also functions as a single-port remote access server.

Patton's Model 2120 Single-Port Terminal Server provides a quick, simple, and cost-effective solution for connecting traditional RS-232 terminals and devices to a local area network. The Model 2120 can be used just about anywhere, including the office, retail outlets, equipment rooms, and on the factory floor. When used with a dial-up modem and connected to a LAN, the Model 2120 also functions as an inexpensive single-port remote access server. The versatile and feature-rich Model 2120 can literally be used in thousands of different applications and environments.

The Model 2120 brings serial RS-232 devices onto the network by encapsulating RS-232 data into IP packets for transport over the LAN. Using Raw TCP or TELNET, the Model 2120 can connect to any user-defined IP address and port. Once connected to the remote host, data is passed transparently end-to-end. The built-in DHCP Client allows the Model 2120 to dynamically obtain an IP address and a subnet mask from a master server. Using dial-up modems and SLIP and PPP connections, remote users can access the network as if they were locally connected.



The Patton Model 2120 Single-Port Terminal Server easily and cost-effectively brings serial RS-232 equipment together with other systems on one local area network!

FEATURES & BENEFITS

- ✓ Enables control of any RS-232 asynchronous serial device over a LAN or via the Internet
- ✓ Asynchronous data rates up to 115.2 kbps
- ✓ DTE/DCE-selectable serial port
- ✓ RS-232 status indicators
- ✓ 802.3 10Base-T LAN connection via RJ-45 for network connection
- ✓ Ethernet link and status indicators
- ✓ User-configurable session options
- ✓ Supports standard TCP/IP protocols (TCP, UDP, IP, ICMP, TELNET, ARP, DHCP, FTP, TFTP, SLIP, PPP, PAP, DNS, and WINS)
- ✓ Comes with 1 Mbyte RAM and 512 kbytes FLASH
- ✓ Small package attaches directly to terminal equipment
- ✓ AC or DC power options
- ✓ Download new software via FTP into FLASH memory
- ✓ 64-user database for enhanced security

LAN-to-LAN Bridging



The Patton Single-Port RS-232 Terminal Server provides the ability to bring virtually any RS-232 device onto the LAN. Using industry-based TCP/IP protocol enables Patton's Single-

Port Terminal Server to provide a standard Ethernet communication link to any type of host. Above is an example of the Model 2120's role in an industrial environment.



I'm Steve, one of Patton's Engineers designing serial device servers. To buy one of these state-of-the-art devices, call +1 301.975.1000 or send e-mail to sales@patton.com.

ORDERING INFORMATION

2120/AM/UI: Single Port RS-232 Terminal Server, Asynchronous, DB-25 Male, UI Power Supply

2120/AM/48: Single Port RS-232 Terminal Server, Asynchronous, DB-25 Male, -48 VDC Power Supply

2120/AF/UI: Single Port RS-232 Terminal Server, Asynchronous, DB-25 Female, UI Power Supply

2120/AF/48: Single Port RS-232 Terminal Server, Asynchronous, DB-25 Female, -48 VDC Power Supply

2120/A9M/UI: Single Port RS-232 Terminal Server, Asynchronous, DB-9 Male, UI Power Supply

2120/A9M/48: Single Port RS-232 Terminal Server, Asynchronous, DB-9 Male, -48 VDC Power Supply

2120/A9F/UI: Single Port RS-232 Terminal Server, Asynchronous, DB-9 Female, UI Power Supply

2120/A9F/48: Single Port RS-232 Terminal Server, Asynchronous, DB-9 Female, -48 VDC Power Supply

SPECIFICATIONS

Serial Interface: DB-25 male or female; DB-9 male or female

Serial Transmission: RS-232 Asynchronous, 0 to 115.2 kbps, configured via serial port or TELNET session

DCE/DTE: Configured via serial port or TELNET session

RS-232 Status Indicators: TXD, RXD, DTR, RTS, CTS, DCD, and Power

Ethernet Interface: RJ-45 female
Ethernet Standard: 10Base-T (IEEE 802.3)

Ethernet Status Indicators: Ethernet link and status

Protocols Supported: TCP, UDP, IP, ICMP, TELNET, ARP, DHCP, FTP, TFTP, SLIP, PPP, PAP, DNS, and WINS

Management Services: Monitoring, control, and diagnostics via serial port or TELNET session

Memory: 1 Mbyte RAM; 512 kbytes FLASH

Power Supply Options: External, universal AC (100–240 VAC) or -48 VDC

Environment: Temp.: 32–122°F (0–50°C) • Humidity: Up to 95% non-condensing

Dimensions: 3.5L X 2.1W X 0.78H in. (9.0L X 5.3W X 1.9H cm)

Weight: 0.2 lbs (0.09 kg)

EtherBITS™ Device Server
Model 2232 Single Port RS-232 Device Server

Low-cost single-port device server lets you monitor, control, and collect data from any async RS-232 device over any IP network.



The Patton EtherBITS Model 2232 lets you leverage the power and flexibility of Ethernet for low-cost, hassle-free device networking.

Ethernet has far outgrown the confines of the office network. From factories and farms to railways and retail shops, credit bureaus, banks—even medical and dental offices—anywhere serial devices are found—the EtherBITS Model 2232 offers network managers the lowest-cost solution for making the transition from legacy serial infrastructure to the age of IP.

The EtherBITS Model 2232 provides both a serial RS-232 port (male or female/DB-9 or DB25) and a 10Base-T Ethernet port to link any RS-232 serial device to the Ethernet LAN at user-selectable data rates from 1200 bps to 115.2 kbps.

The Model 2232 encapsulates asynchronous serial data into IP packets for transport through the network via TCP or TELNET. The Model 2232 delivers a transparent end-to-end connection to your PC or network management host using any user-defined IP address and TCP port number. For greater flexibility, a built-in DHCP client can dynamically obtain an IP address from a master server anywhere on the network. With the included COM Port Redirector software you can use the existing COM/TTY on your PC, thus avoiding the hassle and expense obtaining an additional software license.

Connect serial devices and terminals to Ethernet quickly and easily with Patton's low-cost EtherBITS Model 2232 Single-Port Terminal Server. The Patton EtherBITS Model 2232 lets you leverage the power and flexibility of Ethernet for low-cost, hassle-free device networking.

FEATURES & BENEFITS

- ✓ Control and Monitor Serial Device—Link asynchronous serial devices and terminals to your IP network
- ✓ Supports a Wide Range of Data Rates—User-selectable async data rates up to 115.2 kbps
- ✓ Connects Directly to the LAN—10Base-T LAN connection via shielded RJ-45 connector
- ✓ Standard TCP/IP Protocols Supported—ARP, ICMP, TCP, DHCP client, Telnet
- ✓ COM Port Redirector Software Included—Windows-Tactical COM Port Redirector Linux-vrty drivers

ORDERING INFORMATION

RS-232 to 10Base-T Device Server

2232-25F/E: 10Base-T; DB25F RS-232

2232-25M/E: 10Base-T; DB25M RS-232

2232-9F/E: 10Base-T; DB9F RS-232

2232-9M/E: 10Base-T; DB9M RS-232

Accessories

08057R5DC-700M-EU: EU Desktop Power Supply

08057R5DC-700M-NA: NA Desktop Power Supply

INS/A-DIN-35: Set of DIN rail clips

SPECIFICATIONS

Physical Interface:
Serial: Serial: DB-9M/F; DB-25M/F
Ethernet: Shielded RJ-45

Serial Transmission: RS-232 rates from 1200 bps to 115.2 kbps

Ethernet Transmission: 10Base-T

Management: Monitoring, control, and diagnostics via serial port, TELNET session, or HTTP

LED Indicators: Power, Ethernet Link and Activity, Serial Receive and Transmit

Power: External AC: 9–30 VDC, 300 mA at 9 VDC

Compliance: EMC Directive 89/336/EEC, Low Voltage Directive 73/23/EEC; CE Mark

Environment:
Temperature: 40–122°F (5–50°C)
Humidity: Up to 90% non-condensing

Dimensions: 4.5L x 3.2W x 1.0H in. (9.0L x 5.3W x 1.9H cm)

Weight:
Packaged: 0.66 lbs (300 g)
Unit only: 0.55 lbs (250 g)

Application diagrams

The Model 2232 Single-Port Device Server is used to connect various RS-232 serial devices to the local area network through their serial control ports. The 2232 enables monitoring, control, and data collection from this equipment by remote computers located anywhere on the local or wide area network.

COM Port redirector is provided for users who choose to use their existing serial communication application programs. Using the redirector software provided on the Patton Model 2232 allows existing COM/TTY-based software to be preserved, thus no additional investment is required on additional software.

The Patton Model 2232 can be used for serial data tunneling when used in pairs. When operating in pairs, the 2232s will simulate a direct serial link between two serial devices over an Ethernet connection. Using IP allows the user to extend serial connections from across the building to across the world using the World Wide Web.

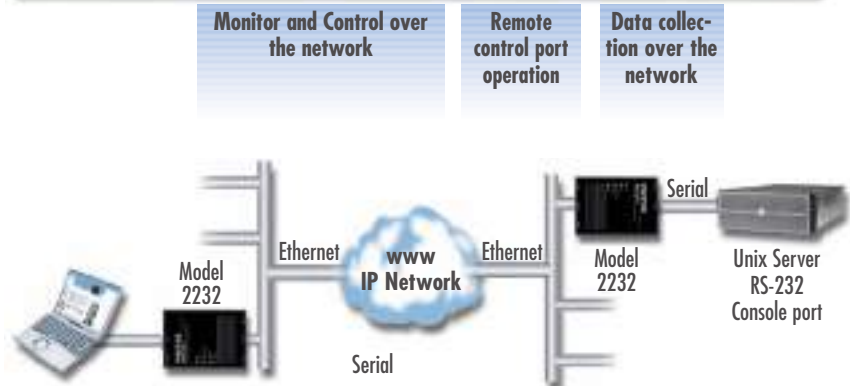

visit us online
www.patton.com

FAST Delivery From Your AUTHORIZED DISTRIBUTOR!



EtherBITS™ Universal Device Server

Model 2285 RS-485/422/232 Device Server

Control, monitor, and collect data from all your serial devices over the local network or Internet. Patton's Model 2285 universal single-port device server is cost-effective and feature-rich, linking virtually any serial RS-485/422/232 device to any IP network over a secure connection.



Use Patton's Model 2285 universal single-port device server to control, access, interconnect, and manage RS-485/422/232 devices from any remote location as if you were there. Patton's device servers provide a new level of efficiency and affordability to a variety of application environments including industrial automation, health care, security, transportation, retail, and many others.

With built-in DHCP the Model 2285 automatically obtains an IP address and a subnet mask from the master server. With the IP address identified and the serial port attached, the Model 2285 can transparently pass data end-to-end using Telnet over TCP. Users can access management features over

telnet, serial console, or the web. Security features include static key based RC4 data encryption, SSL to provide a secure connection between client and server, HTTPS for secure data transfer over the network, and IP filter, which limits and controls access to the serial device. COM Port Redirector is included with Patton's 2285 enabling users to use their existing COM/TTY-based software, preventing the hassle and expense of investing in additional software.

The Patton Model 2285 provides physical-layer connectivity by a user selectable RS-485/422/232 serial port and 10/100Base-TX Ethernet port. Configure the serial port's data rate, ranging from 75 bps to 230 kbps, and choose from a variety of connector types including DB9 or DB25 male or female.

Easily and cost effectively bring serial devices onto one global or local area network!

FEATURES & BENEFITS

- ✓ User Selectable RS-485/422/232—Control, access, and monitor your asynchronous serial terminals and devices over the LAN
- ✓ Secure Communication—Security features include static key based RC4 data encryption, SSL, HTTPS, and IP filtering
- ✓ COM Port Redirector Software Included—Windows®—Tactical COM Port Redirector Linux-vtty drivers
- ✓ Standard TCP/IP Protocols Supported—ARP, ICMP, TCP, Raw TCP, UDP, DHCP, Telnet/SSH, HTTPS, DNS, Dynamic DNS, SNMP v1, & v2, SSL
- ✓ Connects Directly to the LAN—10/100Base-TX LAN connection via RJ-45 connects to any hub/switch

ORDERING INFORMATION

RS-232/422/485 to 10/100Base-T Device Server

2285-9F/E: 10/100; DB9F RS-232/422/485

2285-9M/E: 10/100; DB9M RS-232/422/485

Call for DB25 versions

Accessories

08059DC-700M-EU: EU Desktop Power Supply

08059DC-700M-NA: NA Desktop Power Supply

INS/A-DIN-35: Set of DIN rail clips

SPECIFICATIONS

Physical Interface:

Serial: DB-9M/F; DB-25M/F
Ethernet: Shielded RJ-45

Serial Transmission: RS-485, 422, and 232 rates from 75 bps to 230 kbps (user selectable)

Ethernet Transmission: 10/100Base-TX

Management: Monitoring, control, and diagnostics via serial port, TELNET session, or HTTP

LED Indicators: Power, Ethernet Status, and Activity

Power: External AC: 9~30 VDC, 300 mA at 9 VDC

Compliance: EMC Directive 89/336/EEC, Low Voltage Directive 73/23/EEC; CE Mark

Environment: Temperature: 40~122°F (5~50°C)
Humidity: Up to 90% non-condensing
Dimensions: 4.5L x 3.2W x 1.0H in. (9.0L x 5.3W x 1.9H cm)

Weight: Packaged: 1.05 lbs (0.46 kg)
Unit only: 0.15 lbs (0.06 kg)

Application diagram

The Patton Model 2285 connects various RS-485/422/232 serial devices to a central location over an Ethernet Local Area Network. The device server enables monitoring, controlling, management, and data collection.

The Model 2285 enhances COM Port Redirection with the addition of encryption. Secure connections between the 2285 and the controller's COM port are implemented with the Serial/IP COM port redirector or OpenSSL Toolkit with an SSL security option.

The Model 2285 performs Serial Data Tunneling when used in pairs. The 2285's will simulate a direct serial link between two serial devices over an Ethernet connection. Using IP allows the user to extend serial connections across the building or across the world.



EtherBITS™ Wireless (802.11b) Device Server

Model 2211 Wireless Single-Port Device Server

Best, most cost-effective method to control, monitor, and collect data from your RS-232 serial devices over a wireless local area network.

Ethernet continues to be the predominant office networking infrastructure. Now, Ethernet has made its way from the office to the shop floor. Traditional serial environments require the use of multi-port serial cards, expensive cables, and the personnel to manage multiple systems. Patton's Model 2211 Single-Port Device Server provides a quick, inexpensive, and hassle-free solution for connecting legacy serial terminals and devices to a local area network (LAN).

The Model 2211 links legacy serial RS-232 devices to the network by encapsulating serial data into IP packets for transport over the wireless LAN. Using TCP or TELNET, the Model 2211 can connect to any user-defined IP address and port. Once connected to the remote host, data is passed transparently end-to-end. The built-in DHCP Client allows the Model 2211 to dynamically obtain an IP address and a subnet mask from a

master server. COM Port Redirector is included with Patton's 2211 enabling companies to use their existing COM/TTY-based software, preventing the hassle and expense of investing in additional software.

Physical layer-connectivity is provided via an RS-232 serial port and a 10Base-T Ethernet port. Configure the serial port's data rate, ranging from 1200bps to 115.2 kbps, and choose from a variety of connector types including DB9 or DB25 male or female.

Patton's Model 2211 offers the lowest transition cost in turning your serial infrastructure to IP.



FEATURES & BENEFITS

- ✓ Control and Monitor Serial Device—Control and monitor your serial asynchronous terminals and devices over the local area network
- ✓ Connects Directly to the Wireless LAN—802.11b WiFi 10Base-T LAN connection via built-in WiFi module; 64-bit WEP security
- ✓ Standard TCP/IP Protocols Supported—ARP, ICMP, TCP, DHCP client, Telnet
- ✓ COM Port Redirector Software Included—Windows-Tactical COM Port Redirector Linux-vtty drivers

ORDERING INFORMATION

RS-232 to Wireless 802.11b Device Server

2211-25F/E: 802.11b; DB25F RS-232

2211-25M/E: 802.11b; DB25M RS-232

2211-9F/E: 802.11b; DB9F RS-232

2211-9M/E: 802.11b; DB9M RS-232

Accessories

08059DC-700M-EU: EU Desktop Power Supply

08059DC-700M-NA: NA Desktop Power Supply

INS/A-DIN-35: Set of DIN rail clips

SPECIFICATIONS

Mechanical Interface:

Serial: DB-9M/F; DB-25M/F;
Ethernet: WiFi 802.11b

Serial Transmission: RS-232
Rates from 1200 bps to 115 kbps

Ethernet Transmission:
802.11b Wireless Ad Hoc/Infrastructure
Modes: 10Base-T Ethernet

Management: Monitoring, control,
and diagnostics via serial port or TEL-
NET session

LED Indicators: Power, Ethernet
Link and Activity

Power: External AC: 9–30 VDC,
300mA at 9 VDC

Compliance: EMC Directive
89/336/EEC, Low Voltage Directive
73/23/EEC; CE Mark

Environment

Temperature: 40–122°F (5–50°C)
Humidity: Up to 90% non-condensing

Dimensions: 4.5L x 3.2W x 1.0H
in. (9.0L x 5.3W x 1.9H cm)

Weight: Packaged: 0.66 lbs (300 g)
Unit Only: 0.55 lbs (250 g)

Application diagrams

The Model 2211 Single-Port Device Server is used to connect various RS-232 serial devices to the Local Area Network through their serial control ports. The 2211 enables monitoring, control, and data collection from this equipment by remote computers located anywhere on the local or wide area network. Both Ad hoc and Infrastructure mode is supported on the 2211.

COM Port redirector is provided for users who choose to use their existing serial communication application programs. Utilizing the COM Port redirector software provided on the Patton Model 2211 allows existing COM/TTY-based software to be preserved, thus no additional investment is required on additional software.



visit us online
www.patton.com

FAST Delivery From Your AUTHORIZED DISTRIBUTOR!

PATTON
Electronics Co.

Multi-Port Asynchronous RS-232 Device Server

EtherBITS™ 2234 & 2238 (RS-232)

The 2230 series is a cost effective Multi-Port Device Server enabling user to configure, control, and monitor up to eight RS-232 devices over a Local Area Network.



The EtherBITS family of device servers provide easy, feature rich, secure and reliable serial to LAN, WAN or Internet connectivity. Placing serial devices on to the LAN eliminates the hassle of serial cables, dedicated PCs, and local management. Providing Ethernet connectivity to your serial devices not only protects your current hardware investments, but simplifies future expansions and the management of that hardware.

LAN connectivity of your serial devices gives you the ability to remotely manage serial devices from anywhere in the world.

The EtherBITS 2230 series encapsulates the asynchronous serial data of up to 8+1 ports into IP packets for transport through the network via TCP or TELNET. Patton's COM port redirector software makes it possible to establish a connection between the host and a networked serial device by creating a local COM or TTY port on the host computer, allowing existing software applications to work without modification.

The EtherBITS 2230 support a host of applications including industrial automation, credit bureaus, banks, point-of-sale, utilities, and any other applications that require asynchronous RS-232 serial to IP connectivity.

FEATURES & BENEFITS

- ✓ High-density desk top box allows up to 8+1 Async RS-232 to connect to the LAN or WAN.
- ✓ Individually configurable serial channel with speeds of 1200bps to 230 kbps
- ✓ Hardware (RTS/CTS) and software flow control (XON/XOFF)
- ✓ User configurable IP services ensure reliable connectivity to any LAN or WAN. NAT, DHCP and Firewall permits advanced networking and flexibility.
- ✓ Ensure data is secure end to end using IPsec with DES/3DES.
- ✓ Configure and control up to 8 serial devices with Web-based management, SNMP, or command line all with password protection.

SPECIFICATIONS

Terminal/Channel Ports: Serial Asynchronous start-stop • # of Ports: 8 ports (3038); 4 ports (3034) • Max Aggregate Speed: 2Mbps • Interface: CCITT V.24 (EIA-561) on 8-pin RJ-45F • Data Communication Speed: Selectable 50bps-115.2kbps; auto-speed detection up to 115.2kbps • Data Format: Selectable 5,6,7, or 8 bits; 1, 1.5 or 2 stop bits, odd, even, or no parity • Flow Control: Software selectable (XON/XOFF) or hardware (RTS/CTS) in both directions • Break Propagation: Transparent • EIA signal propagation: Status of local DTR signal can be propagated to the remote end • Echo: Character echo can be selectively enabled for each terminal port

Ethernet Port(s): Auto-sensing 10/100BaseTX MDI-X Ethernet • Clock: Receive clock: external; Transmit clock: selectable as internal or external

Supervisory Port(s): Interface Auto-sensing 10/100BaseTX MDI-X on RJ-45 or Serial RS-232 (EIA-561) on RJ-45 • Serial Communication protocol: Asynchronous start-stop • Serial Speed: 300, 1200, 4800, or 9600 bps • Serial Data format: 7/8 bits, 2 stop bits, odd/even/no parity • Echo: Optional

Commands: Set/modify/view parameters • View status • Store

parameters in non-volatile memory • Copy parameters between ports • Provide local/remote loop backs on port • Establish connection between supervisory and terminal ports • Obtain statistic reports • Unit reset; individual port reset • Remote supervisory access • Enable/Disable remote access

IP Services Supported: IPv4 • RIPv1 and v2 (RFC 1058 and 2453) • ICMP redirect (RFC 792); packet fragmentation • DiffServ/ToS set or queue per header bits • Packet policing discards excess traffic • 802.1p/Q VLAN support with 4096 IDs • IPSEC AH & ESP Modes • Manual/IKE keying • AES/DES/3DES Encryption

IP Connectivity Supported: TCPRAW • UDP • Telnet • DHCP • NAT

Operating Environment: Temp.: 0-40°C • Humidity: 5-80% (non condensing)

System: CPU Motorola MPC859 @ 50 MHz • Memory 16MB SDRAM/4MB Flash • Power: 100-240 VAC (50/60 Hz) • Power dissipation: 4W

Compliance: EMC compliance: EN55022 and EN55024 • Safety compliance: EN 50950 • CE compliance FCC Part 15 Class A

Application diagram

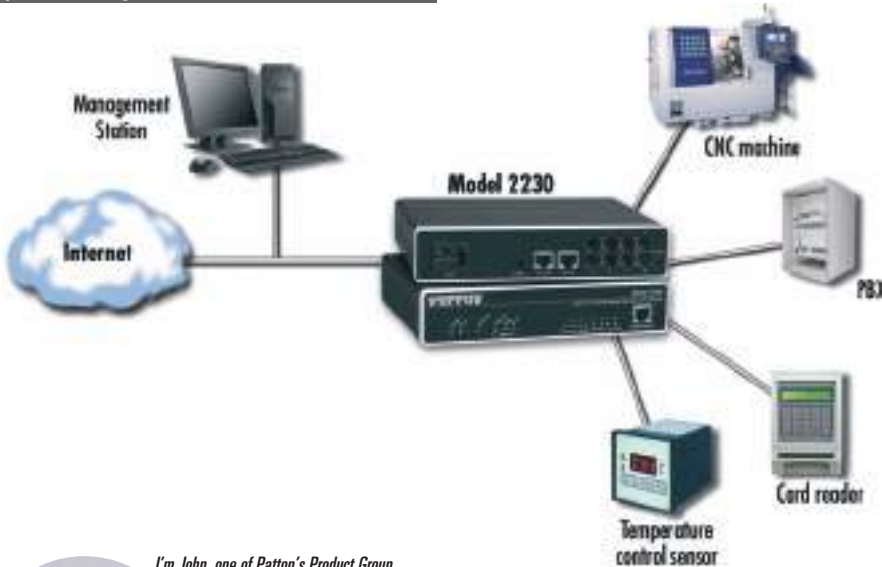

I'm John, one of Patton's Product Group Managers. If you do not find what you need at www.patton.com or in this catalog, or if you have technical questions or comments concerning Device Servers, please call me at +1 301.975.1000, x160. You can also send e-mail to jgrant@patton.com.



ORDERING INFORMATION

2234/EUI: 4 port RS-232

2234/E48: 4 port RS-232

2238/EUI: 8 port RS-232

2238/E48: 8 port RS-232

Multi-Port Async. RS-232/422/485 Device Server Models 2284 & 2288 (MEI)

The 2280 series is a versatile Multi-Port Device Server enabling user to configure, control, and monitor up to eight RS-232/422/485 DCE or DTE devices over a Local Area Network.



The EtherBITS family of device servers provide easy, feature rich, secure and reliable serial to LAN, WAN or Internet connectivity. Placing serial devices on to the LAN eliminates the hassle of serial cables, dedicated PCs, and local management. Providing Ethernet connectivity to your serial devices not only protects your current hardware investments, but simplifies future expansions and the management of that

hardware. LAN connectivity of your serial devices gives you the ability to remotely manage serial devices from anywhere in the world.

The EtherBITS 2280 series encapsulates the asynchronous serial data of up to 8+1 ports into IP packets for transport through the network via TCP or TELNET. Patton's COM port redirector software makes it possible to establish a connection between the host and a networked serial device by creating a local COM or TTY port on the host computer, allowing existing software applications to work without modification.

The EtherBITS 2280 support a host of applications including industrial automation, credit bureaus, banks, point-of-sale, utilities, and any other applications that require asynchronous RS-232/422/485 serial to IP connectivity.

FEATURES & BENEFITS

- ✓ High-density desk top box allows up to 8+1 Async DCE or DTE RS232/422/485 to connect to the LAN or WAN.
- ✓ Individually configurable serial channel with speeds of 1200 bps to 230 kbps
- ✓ Per port DCE or DTE configurable
- ✓ Hardware (RTS/CTS) and software flow control (XON/XOFF)
- ✓ User configurable IP services ensure reliable connectivity to any LAN or WAN. NAT, DHCP and Firewall permits advanced networking and flexibility.
- ✓ IPsec with DES/3DES ensures data is secure end-to-end.
- ✓ Configure and control up to 8 serial devices with Web-based management, SNMP, or command line all with password protection.

SPECIFICATIONS

Terminal/Channel Ports: Serial Asynchronous start-stop • # of Ports: 8 ports (3038); 4 ports (3034) • Max Aggregate Speed: 2Mbps • Interface: CCITT V.24 (EIA-561) on 8-pin RJ-45F • Data Communication Speed: Selectable 50bps-115.2kbps; auto-speed detection up to 115.2kbps • Data Format: Selectable 5,6,7, or 8 bits; 1, 1.5 or 2 stop bits, odd, even, or no parity • Flow Control: Software selectable (XON/XOFF) or hardware (RTS/CTS) in both directions • Break Propagation: Transparent • EIA signal propagation: Status of local DTR signal can be propagated to the remote end • Echo: Character echo can be selectively enabled for each terminal port

Ethernet Port(s): Auto-sensing 10/100BaseTX MDI-X Ethernet • Clock: Receive clock: external; Transmit clock: selectable as internal or external

Supervisory Port(s): Interface Auto-sensing 10/100BaseTX MDI-X on RJ-45 or Serial RS-232 (EIA-561) on RJ-45 • Serial Communication protocol: Asynchronous start-stop • Serial Speed: 300, 1200, 4800, or 9600 bps • Serial Data format: 7/8 bits, 2 stop bits, odd/even/no parity • Echo: Optional

Commands: Set/modify/view parameters • View status • Store

parameters in non-volatile memory • Copy parameters between ports • Provide local/remote loop backs on port • Establish connection between supervisory and terminal ports • Obtain statistic reports • Unit reset; individual port reset • Remote supervisory access • Enable/Disable remote access

IP Services Supported: IPv4 • RIPv1 and v2 (RFC 1058 and 2453) • ICMP redirect (RFC 792); packet fragmentation • DiffServ/ToS set or queue per header bits • Packet policing discards excess traffic • 802.1p/Q VLAN support with 4096 IDs • IPSEC AH & ESP Modes • Manual/KE keying • AES/DES/3DES Encryption

IP Connectivity Supported: TCPRAW • UDP • Telnet • DHCP • NAT

Operating Environment: Temp.: 0-40°C • Humidity: 5-80% (non condensing)

System: CPU Motorola MPC859 @ 50 MHz • Memory 16MB SDRAM/4MB Flash • Power: 100-240 VAC (50/60 Hz) • Power dissipation: 4W

Compliance: EMC compliance: EN55022 and EN55024 • Safety compliance: EN 50950 • CE compliance FCC Part 15 Class A

Application diagram

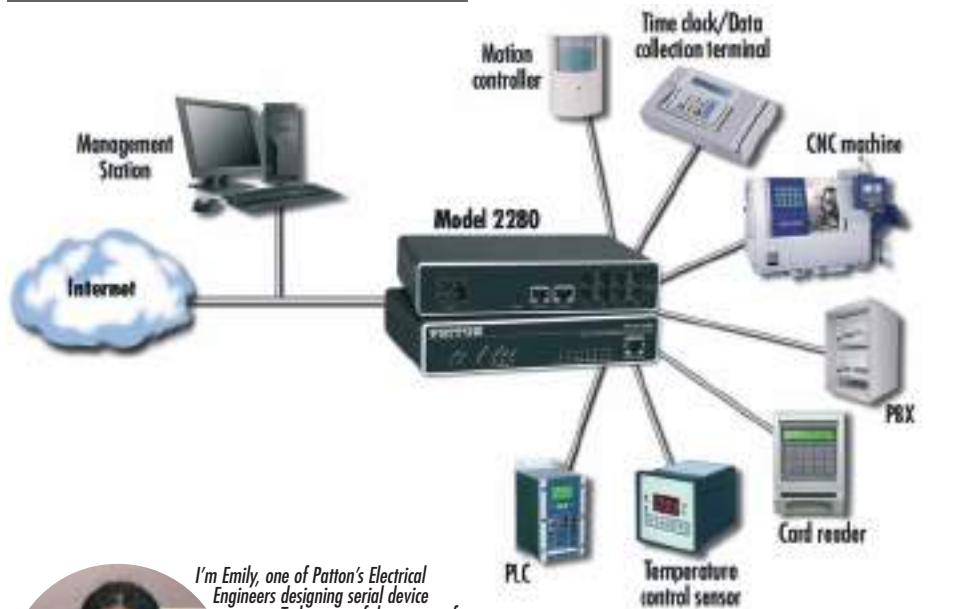

I'm Emily, one of Patton's Electrical Engineers designing serial device servers. To buy one of these state-of-the-art devices, call +1 301.975.1000 or send e-mail to sales@patton.com.

ORDERING INFORMATION

2284/EUI: 4 port 232/422/485

2284/E48: 4 port 232/422/485

2288/EUI: 8 port 232/422/485

2288/E48: 8 port 232/422/485

visit us online
www.patton.com

FAST Delivery From Your AUTHORIZED DISTRIBUTOR!

PATTON
Electronics Co.

Leased-Line Extender over IP**Models 2292 & 2294**

Save leased-line costs extending up to four audio lines between two locations over any IP network. Patton's Leased-line extenders provide PSTN grade voice quality and integrated QoS mechanisms enable it to work reliably even over the public Internet.



The Leased-Line Extender product family gives you the ability to save big on Leased-Line costs. Using only one Extender on each side, audio information on up to four Leased-Lines can be transported over a packet-based network. This means: Internet access in two different locations around the world is sufficient to establish up to four Leased-Lines between these two locations!

The Extenders ship as a matched pair—and after installation, the connection between the two establishes immediately. It also re-establishes after any kind of problem, should it be needed. The connection is secured with hardware-accelerated 3DES or AES encryption end-to-end between the Extenders, preventing wiretapping and making Patton the right choice for security conscious enterprises.

For advanced users, the Extenders can be bought separately, and multiple Extenders can be arranged in a multi-location formation. This allows e.g. always-on direct intercom between different locations or posts. The integrated SIP and H.323 voice-over-IP (VoIP) protocols enable any VoIP phone system to talk to the Extenders—finally offering real audio interfaces. An intelligent agent inside the Patton 2292 and 2294 can assure the VoIP calls are always up.

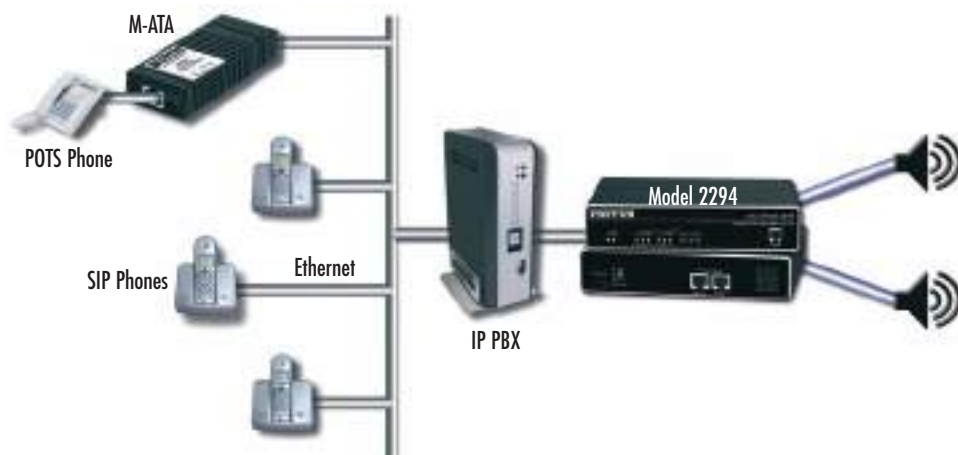
The 2292 and 2294 extend leased lines over any IP network**The 2292 and 2294 provide audio interfaces to any VoIP system****FEATURES & BENEFITS**

- ✓ **Security**—Connections are always-on and securely encrypted with IPsec and IKE. Choose DES/3DES or AES.
- ✓ **Quality**—Advanced traffic management and shaping, combined with Patton's patent-pending DownStream QoS™ enforce uninterrupted toll-quality voice over best-effort networks.
- ✓ **Integrated access router** with NAT, Firewall, ACL, PPPoE, DHCP, DynDNS and VLAN
- ✓ **Connects analog 2-wire 600-ohm voice-grade interfaces** via a G.711 RTP stream.
- ✓ **Narrow-band FXS style 2-wire hybrid T/R.**
- ✓ **Talks SIP and H.323**—adds real audio interfaces to SIP and H.323 signaling systems.

SPECIFICATIONS

Capacity: 2 audio lines (2292) 4 audio lines (2294)

Audio connectivity: 2-wire RJ-11, Bandwidth 4kHz, Impedance 600-ohm, Narrow Band FXS style hybrid transmit/receive

Data Services: Two 10/100 Ethernet ports • Complete IP access router • DHCP Client & server • Packet fragmentation • Static firewall, NAT, NAPT RFC 1631 access control lists • DMZ port • IPsec, IKE, AES/DES/3DES Encryption

Quality of Service: Audio priority • DownStreamQoS™ • Traffic management, shaping and policing • IEEE 802.1p, TOS, DiffServ labeling • IEEE 802.1Q, VLAN tag insertion/deletion (simultaneous support of multiple VLANs) Voice Signaling: H.323v4, SIPv2 (B2BUA capable, multi-instance, simultaneous support of multiple registrars and direct IP dialing) • SIP call transfer, redirect • DTMF in-band & out-of-band

Voice Processing: CODEC G.711 a-law/mu-law, G.723, G.729ab, • G.726, G.727, T.38 fax relay (9.6 k, 14.4k) • G.711 transparent fax and bypass

Management: Web/HTTP, CLI with local console and remote Telnet access • TFTP configuration & firmware loading • SNMP MIB II and product MIB • Secure Mass provisioning for both firmware and unit configuration • Built-in diagnostic tools (trace, debug, call generator)

System: CPU Motorola MPC875 @66MHz • Memory 32MB SDRAM/8MB Flash • Power 100–240 VAC (50/60Hz) • Power dissipation 4–8W, model dependent

Temperature: 32–104°F (0–40°C)

Humidity: 5–80%, non-condensing
Compliance: EMC compliance: EN55022 and EN55024 • Safety compliance: EN 60950 • CE compliance • FCC Part 15 Class A • RoHS

ORDERING INFORMATION

2292/EUI-2PK: Dual port 2-wire Leased-Line audio over IP Extender, dual 10/100 Ethernet, UI power. Package contains two matched units.

2294/EUI-2PK: Quad port 2-wire Leased-Line audio over IP Extender, dual 10/100 Ethernet, UI power. Package contains two matched units

2292/EUI: Dual port 2-wire Leased-Line audio over IP Extender, dual 10/100 Ethernet, UI power. Single unit for integration in existing SIP or H.323 networks

2294/EUI: Quad port 2-wire Leased-Line audio over IP Extender, dual 10/100 Ethernet, UI power. Single unit for integration in existing SIP or H.323 networks.

EtherBITS™ Bluetooth IP Access Point

Model 2188

The Model 2188 provides hassle-free wireless Bluetooth to IP connections for up to 7 Bluetooth devices

Patton's Model 2188 enables up to 7 Bluetooth devices to simultaneously connect to any 10/100Base-TX Ethernet Network. Using the 2188 in conjunction with the Model 1013 eliminates the hassle and expense of running a dedicated cable connection between RS-232 devices thus giving installers, maintenance workers, and others the ability to remotely monitor and control RS-232 devices.

The Model 2188 supports multiple Bluetooth profiles for the serial port, dial-up networking, LAN access and PAN.



Versatile host modes allow for a wide variety of user applications such as, TCP Server and Client modes for TCP/IP-Bluetooth replay applications, Vertex mode for multicasting, repeater mode, serial hub mode, and RS-232 mode.

The Model 2188's flash memory allows for easy field upgradeable software upgrades. A built in web server and web interface allows for simple installation and remote configuration and management.

FEATURES & BENEFITS

- ✓ RS-232 Serial Cable Replacement—Bluetooth connections can be made over 3,280 feet (1,000 meters).
- ✓ Wide Variety of supported Bluetooth Profiles—Serial Port, LAN Access, PAN and Dial up Networking.
- ✓ Supports Many Applications & Host Modes—TCP Server & Client, Vertex mode, Repeater mode, and RS-232 modes.
- ✓ Network Protocols Supported—HTTP/FTP/Telnet/IP Sharing/DHCP/PPP/RADIUS Authentication SNMP v1/v2/v3



Application diagram



Bluetooth enables wireless RS-232 connections, making installations and service calls more efficient by eliminating the time, hassle, and expense of cable runs.

Antenna Distance Chart	
Default Antenna to Default Antenna	328 feet (100 meters)
Default Antenna to Dipole Antenna	492 feet (150 meters)
Dipole Antenna to Dipole Antenna	656 feet (200 meters)
Patch Antenna to Dipole Antenna	1,312 feet (400 meters)
Patch Antenna to Patch Antenna	3,937 feet (1,200 meters)

ORDERING INFORMATION

2188/EUI: EtherBITS Bluetooth to IP Access Point

Accessories

1013: Wireless RS-232 Short Range Modem

10-BT-SAT: Bluetooth Stub Replacement Antenna

10-BT-DAT: Bluetooth Dipole Antenna

10-BT-PAT: Bluetooth Patch Antenna

10-BT-UPA: Bluetooth USB to Power Adapter Cable

10-BT-DPA: Bluetooth DC to Power Adapter Cable

10-BT-CBL-1: Bluetooth 1M Antenna Extension Cable

SPECIFICATIONS

Ethernet Interface:
10/100BaseTX connection via RJ45 • Static IP and Dynamic IP address

Bluetooth Interface: Bluetooth V1.1; Class 1 • Level: -18dBm • Profiles: Serial Port, LAN Access, PAN, Dial up Networking • Distance: 32–1,312 feet (10–400 meters) • Protocols Supported: HTTP; FTP, Telnet, DHCP client; SNMP v1/v2/v3; PPP server and PPP tunneling; RADIUS •

Management: Windows Utility; Web, Telnet, Console; Modem AT command set • Diagnostic LEDs: Power, Status, Error, NET and EXP

General Product Specifications: Operating Temperature: 40–122°F (5–50° C) • Dimensions: 5.8L x 4.4W x 1.3H inch (147 L x 112 W x 32H mm) • Weight: 0.5 lbs (225 g)

visit us online
www.patton.com

FAST Delivery From Your AUTHORIZED DISTRIBUTOR!



Network Termination

T1/E1, EVFE1 CSU/DSU Products

For T1/E1 network termination, Patton's products offer flexible access and connectivity for less!

- ✓ Patton products come in a variety of packages and satisfy any requirement—from miniature, full-featured units to desktop and rack card solutions.
- ✓ Whether you need to connect to X.21, V.35, EIA-530, or Ethernet—Patton has the DTE interface solution.
- ✓ Patton T1/E1 products connect your router, multiplexer, or PBX to a variety of voice or data services: from leased-line Point-to-Point, to Frame Relay, to Internet access, all products connect at full or fractional speeds.

Domestic Series T1-Based Solutions

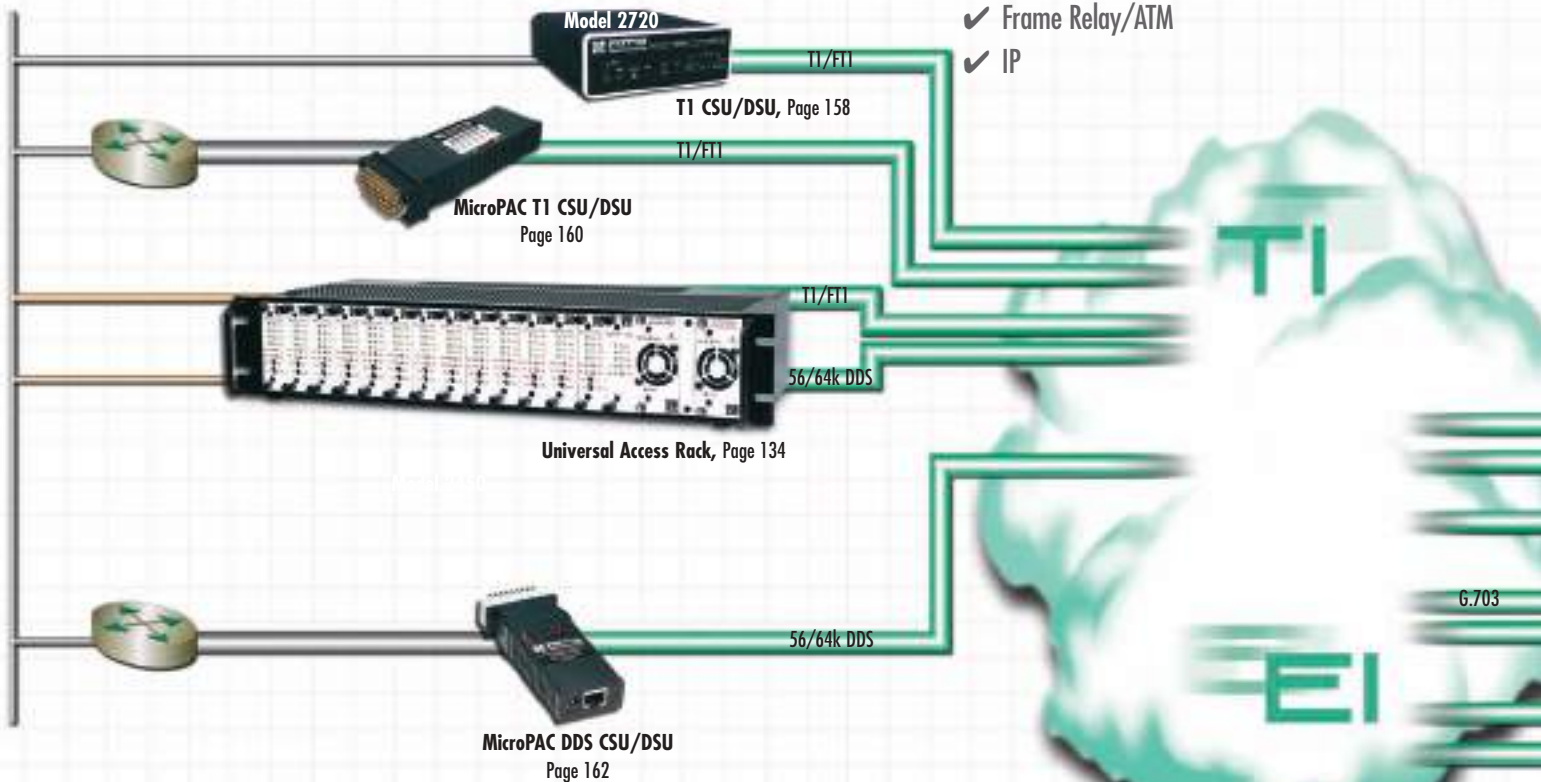

Both T1 and E1 CSU/DSU with full IP Routing.

Patton's new drop-and-insert DiamondLink™ Router is a low cost and robust enterprise solution for the global economy. This one router can be used anywhere in the world to offer TDM and routed services over one circuit.

Page 168

This router supports
T1 and E1



T1/FT1, E1/FE1 CSU/DSU/Router

Access Without Excess

Patton's EtherRockets for T1/E1 IP Services.

Equipped with a 10Base-T Ethernet front-end and a T1 or E1 interface, the EtherRocket with Remote Router Porting (RRP) seamlessly connects your LAN to an Internet service provider (ISP) or connects a branch office to headquarters via point-to-point leased-lines. All without a router at the customer premises.

International Series E1-Based Solutions

ACCESS CONVERSION

- ✓ Mega-Stream & Kilo-Stream
- ✓ ISDN/PBX
- ✓ IP

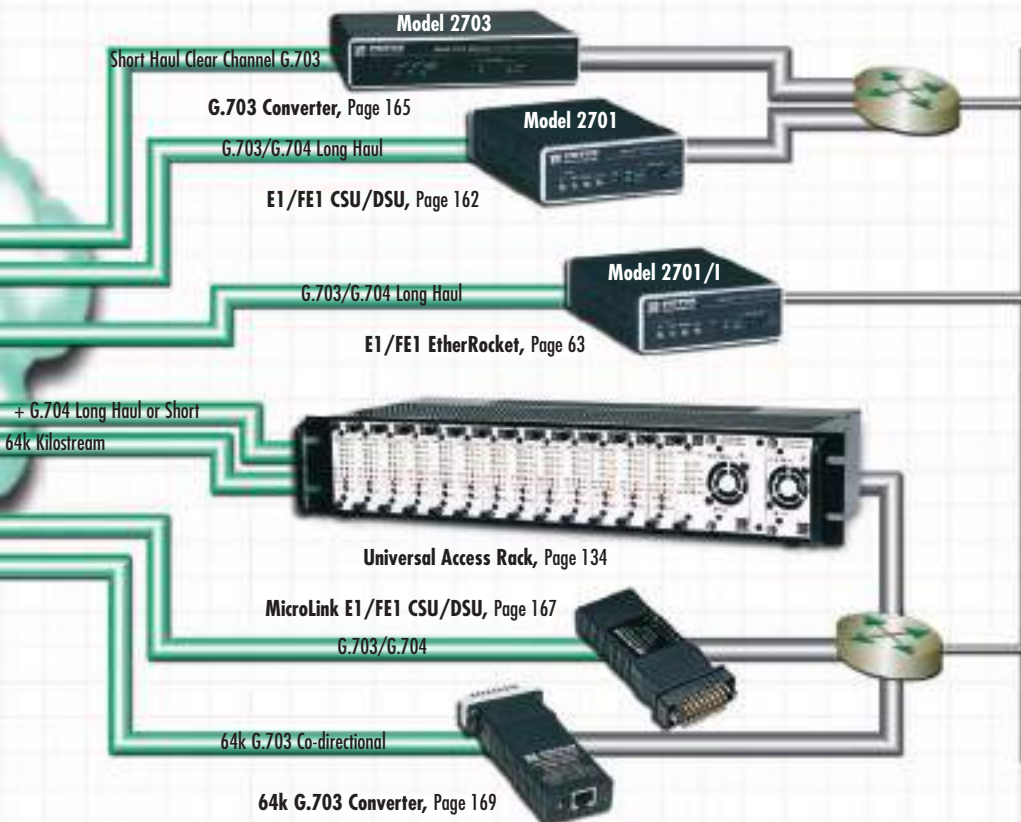

In This Section

T1 Network Access 158

Compact T1/FT1 CSU/DSU	158
T1/FT1 to V.35 Converter & CSU/DSU	160
T1/FT1 High-Density, CSU/DSU Rack Card	161

E1/G.703 Access Converters 162

MicroLink™ CSU/DSU	162
G.703/G.704 NTU	162
MicroPak™ G.703 Interface Converter	165
MegaLink-IT™ 2 Mbps G.703 Access Converter	165

64-K G.703 Access Converters 166

Lowest Cost G.703 NTU	166
MicroLink-E1™ E1/FE1 Nx64 CSU/DSU	167
Integrated TDM & IP Routers	168
Co-directional G.703 Converters	169
G.703/64-kbps Interface Converter	169

Protect your T1/E1 infrastructure!

Imagine the cost to your business if simple and preventable surge damage cuts your Internet life-line or damages your PBX. Use Patton's Model 552 Series WAN protectors to guard your investments today!





See
Pg 226

Compact, T1/FT1, High Density, Low Cost CSU/DSU

Model 2720

New CSU/DSU makes it simple and affordable to connect to T1/Fractional T1 services.

The NetLink Model 2720 Series T1/FT1 CSU/DSU provides high speed WAN connectivity in a compact full-featured standalone package.

The NetLink 2720 is an excellent choice for terminating leased lines, Frame Relay backbones, Internet access, and LAN-to-LAN services. When terminating a T1-dedicated digital circuit, the NetLink 2720 supports nx56/nx64 kbps T1 framing and converts to V.35, RS-530, or 10Base-T Ethernet interfaces.

The NetLink 2720 supports D4/ESF framing options and AMI/B8ZS/B7ZS line coding. Data rates, framing, and coding options are programmed by DIP switches or from a VT-100 terminal with menu-driven software. A full range of system and diagnostic features make setup simple and easy.

The Model 2720/1 (10 Base-T Ethernet Bridge) is particularly suited for LAN-to-LAN connection without the need for routers! MAC forwarding and PPP/BCP built-in bridging provides seamless connection over the T1 link.



The PPP/BCP features also enable customers to extend a router's serial interface and connect to a remote Ethernet LAN over the T1 network.

The 2710RC is the rack card companion to the Model 2720. Offering all features found in the 2720, the 2710RC fits in a 19-inch, 2U high rack housing up to 16 rack cards.



FEATURES & BENEFITS

- ✓ Terminates T1/FT1 circuits over a 4-wire RJ-48C interface
- ✓ 100–240VAC and -48VDC power options
- ✓ Connects to V.35, EIA-530, and Ethernet interfaces
- ✓ Ethernet version for LAN to LAN Bridging
- ✓ Common framed n x 56/64 kbps rates up to 1.536 Mbps
- ✓ Unstructured rates at 1.544 Mbps
- ✓ D4 or ESF framing modes
- ✓ Supports AMI or B8ZS/B7ZS line coding
- ✓ Software or DIP switch configurable
- ✓ Internal, external, or network clocking
- ✓ V.54, V.52, and CO Loop and Loop down diagnostics
- ✓ Available in Rackmount version (Model 2710RC)
- ✓ Also functions as a high speed point-to-point modem
- ✓ Made in USA

Connecting a branch office to headquarters using the 2720/1 "EtherRocket" and remote router porting

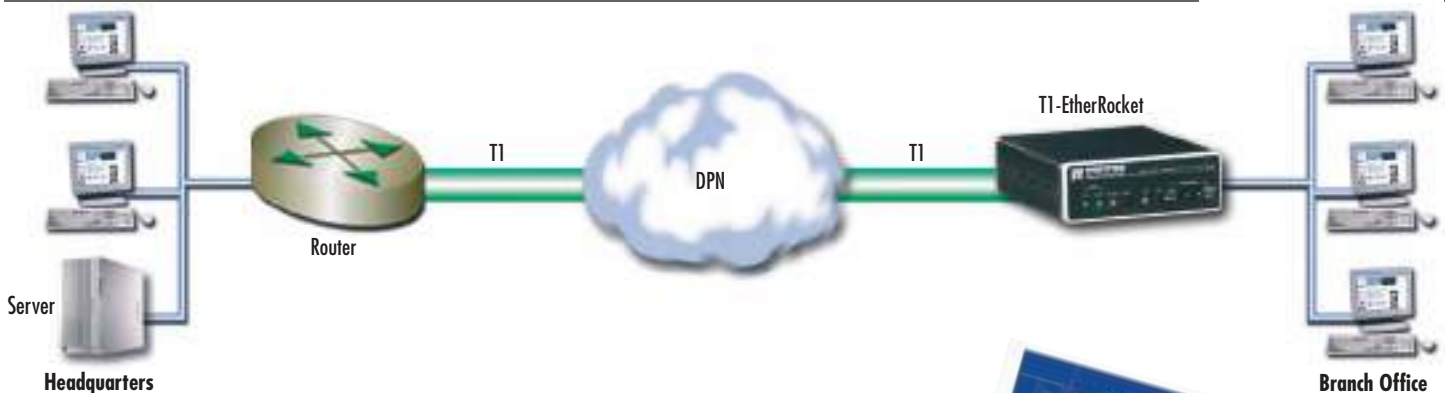

Download our free "Remote Router Porting with T1" position paper and learn how to use the EtherRocket to connect small or branch offices without the cost and headache of a remote router. Go to www.patton.com/support/library.shtml for your free copy.



Software management

In addition to DIP switch configuration, the Models 2720 and 2710RC can be easily configured, tested, and monitored via intuitive software menus. The Model 2720 includes an RS-232 port and cable for connection to a PC or terminal. Simply start a terminal program in your PC (Hyperterminal, for example) to gain access to a complete set of configuration parameters and diagnostics. Access to configuration menus in the Model 2710RC requires the use of a Patton 1001CC module card installed in the rack. A 1001CC card can access up to 15 2710RC modems per rack.

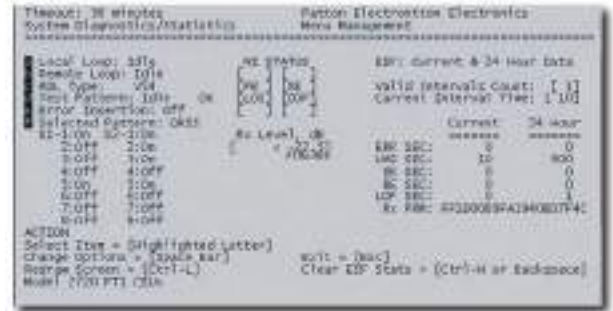

T1 network termination on V.35 or EIA-530 for data



The Models 2720 and 2710RC T1 CSU/DSUs come with V.35 or EIA-530 for simple connection to routers or multiplexers at the customer or service provider premises. The 2720 and 2710RC

connects easily to your router and T1 line and provides termination to fractional or full T1 services. The CSU/DSUs work in D4 or ESF T1 framing modes, and are transparent to any WAN

protocol originating at the local router such as ATM/FR/PPP or voice services.

LAN-to-LAN without a router



In the most common installations of WAN Ethernet bridging, two LAN segments are connected with a common WAN interface such as T1. Each T1 EtherRocket connects to the local

Ethernet LAN and builds a table of local hosts on that network. If an Ethernet message is not for a local host, the EtherRocket forwards it over the WAN to the remote EtherRocket. User on

a LAN segment can access hosts and applications at the far end LAN as easily as if they were located on the local LAN.

SPECIFICATIONS

WAN Speed: 1.544 Mbps
WAN Connection: RJ-48C
Nominal Impedance: 100 Ohms
DTE Interface: EIA-530, V.35, 10Base-T Ethernet
Line Coding: AMI/B8ZS
Line Framing: D4/ESF/Unframed
Clock Options: Internal, external, or network
Diagnostics: Responds to CO-initiated D4 loop-up and loop-down codes, ESF line loop and payload loop FDL messages, and universal loopback de-activate messages

Transmit LBO: Selectable—0, 7.5, 15, or 22.5 dB, plus DSX-1
Standards: AT&T TR62411, TR54016, and ANSI T1.403
Dimensions: 0.78H x 2.1W x 3.5D in. (2.0H x 5.3W x 8.9D cm)
Test Modes: Initiates and responds to V.54 and CSU remote loops; local loop Pattern Generator/Detector; User selectable 511, 2047, or QRSS
Power: Universal input (100–240 VAC), or -48VDC

ORDERING INFORMATION

2720/B/UI: Standalone T1/FT1 CSU/DSU; EIA-530 Interface (DB-25F); 90–240 VAC supply
2720/C/UI: Standalone T1/FT1 CSU/DSU; V.35 (M/34F) Interface; 90–240 VAC supply
2720/I/UI: Standalone T1/FT1 CSU/DSU; 10Base-T (RJ-45) Interface; 90–240 VAC supply

2720/B/48: Standalone T1/FT1 CSU/DSU; EIA-530 (DB-25F) Interface; 48 VDC supply
2720/C/48: Standalone T1/FT1 CSU/DSU; V.35 (M/34F) Interface; 90–240 VAC supply
2720/I/48: Standalone T1/FT1 CSU/DSU; 10Base-T (RJ-45) Interface; 90–240 VAC supply

visit us online
www.patton.com

FAST Delivery From Your AUTHORIZED DISTRIBUTOR!





See
Pg 228

T1/FT1 to V.35 Interface Converter/CSU/DSU with Control Port

Model 2710

Pocket-sized converter-CSU/DSU makes it simple and affordable to connect V.35 to T1 or Fractional T1 (Nx64).

The Model 2710 T1-to-V.35 interface converter/CSU/DSU connects to a 4-wire T1 circuit and plugs directly into the V.35 interface of a router, switch or multiplexer.

Connecting to an unstructured T1 circuit at 1.544 Mbps, the Model 2710 also supports nx56/64 framed connections at data rates from 128 kbps to 1.536 Mbps. In addition, the Model 2710 may be used in pairs in point-to-point applications, where it is able to connect two V.35 devices at data rates to 1.544 Mbps over distances to 6,000 ft (1.14 miles/1.82 km).

The Model 2710 supports D4/AMI or B8ZS/ESF line coding and framing, internal or network clocking, and selectable 0, 7.5, or 22.5 dB line build-out (LBO) levels. These parameters are user configurable via internal DIP switch settings, or through software commands using the Model 2710's RS-232 control port. The Model 2710 is also configurable for



clear channel (1.544 Mbps) or fractional (nx56/64 kbps) operation. Fractional settings include 2, 4, 6, 8, 12, 16, and 24 channels (for example, setting the Patton 2710 at 224/256 kbps would activate four 56/64 kbps channels).

Power is supplied to the Model 2710 through an external AC power supply.

FEATURES & BENEFITS

- ✓ Plugs directly into V.35 interface of router, switch or multiplexer
- ✓ Connects to an unstructured 4-wire T1 circuit at 1.544 Mbps
- ✓ Supports n x 56/64 framed T1 connections from 64 kbps to 1.536 Mbps
- ✓ Data rates, clocking and LBO levels selected by internal DIP switches or via an RS-232 software control port
- ✓ Facilitates point-to-point campus communication up to 6,000 ft (1.14 miles/1.82 km) when used in pairs
- ✓ Supports D4/AMI or B8ZS/ESF line coding, loopback diagnostics
- ✓ Seven easy-to-read diagnostic LEDs



I'm Maria, one of Patton's Sales Coordinators. If you have questions about our products, call +1 301.975.1000 or send e-mail to sales@patton.com.



Application diagram

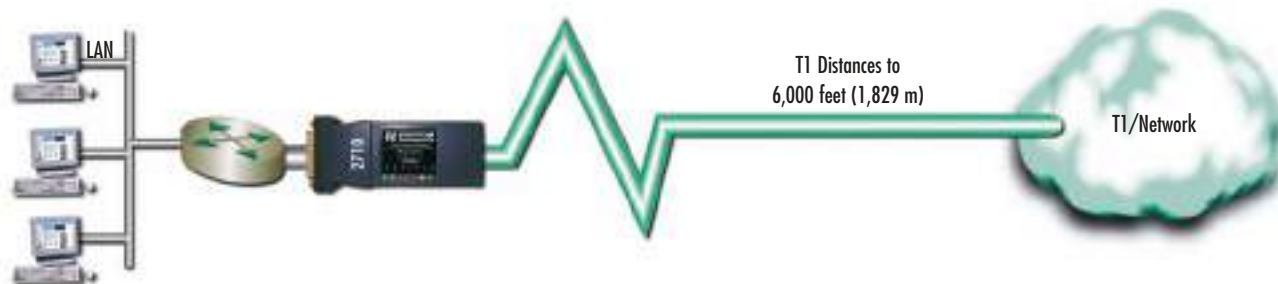

SPECIFICATIONS

Transmission Format: Synchronous, 4-wire

Network Connection: RJ-48C

Nominal Impedance: 100 ohms

Network Line Speed: 1.544 Mbps

Distance: Up to 6,000 feet, point-to-point (when used in pairs)

DTE Data Rates: Switch selectable nx56/64, 128 kbps–1.536 Mbps

DTE Interface: Integral V.35 (M/34 male) connector

Line Coding/Framing: AMI/B8ZS or D4/ESF

Transmit LBO: Selectable—0, 7.5, or 22.5 dB

Receive LBO: Automatic

Clocking: Internal or Network

LED Status Indicators: TXD, RXD, LOS (loss of signal), ALM (alarm), ERR (error), TST (test), PWR

Power: External AC power supply

Diagnostics: Responds to CD initiated D4 loopup and loopdown codes, ESF line loop and payload loop FDL messages, universal loopback de-activate message

Compliance: CE Marked per EMC Directive 89/336/EEC and Low Voltage Directive 73/23/EEC; FCC Part 15, Class A; Canadian DOC CS 03

Standards: AT&T TR62411, ANSI T1.403, TR54016

Dimensions: 5.0 L x 2.1W x 0.81D in. (12.7L x 5.3W x 2.1D cm)

Weight: 2.02 lbs. (0.92 kg)

ORDERING INFORMATION

2710/CM/UJ: T1/FT1 Nx64 with control port (V.35, M/34 male, 100–240 VAC)

2710/CM/-48: T1/FT1 Nx64 with control port (V.35, M/34 male, 48 VDC)

Note: Adapter cables are available for connecting the Model 2710 to WAN equipment that does not use a standard V.35 interface (such as the Cisco 2501 router, which uses a high density 60-pin connector).



T1/FT1 High-Density, Low Cost CSU/DSU Rack Card

Model 2710RC

T1/Fractional-T1 CSU/DSU rack card connects to a space-saving, SNMP-manageable platform.

The NetLink-T1 Model 2710RC Series are T1/FT1 CSU/DSUs that provide high speed WAN connectivity in a rack card package. Patton's 2U (8.9-cm) redundant AC/DC rack chassis accepts up to 16 rack cards, saving valuable space in central site locations.

NetLink 2710RC is an excellent choice for terminating leased lines, Frame Relay backbones, Internet access, and LAN-to-LAN services. When terminating a T1-dedicated digital circuit, the NetLink 2710RC supports nx56 kbps and nx64 kbps framing for T1 and V.35, X.21, RS-530, or 10Base-T Ethernet interfaces.

The NetLink 2710RC supports D4/ESF framing options and AMI/B8ZS/B7ZS line coding. Data rates, framing, and coding options are programmed by DIP switches or from a VT-100 terminal with menu-driven software. The NetLink



2710RC also supports SNMP management from a NetLink Model 1001MC SNMP/HTTP rack card. A full range of system and diagnostic features make setup simple and easy.

FEATURES & BENEFITS

- ✓ Terminates T1/FT1 circuits over a 4-wire RJ-48C interface
- ✓ Connects to standard CPE serial and Ethernet interfaces
- ✓ Common framed n x 56/64 kbps rates up to 1.536 Mbps
- ✓ Unstructured rates at 1.544 Mbps
- ✓ D4 or ESF framing modes
- ✓ Supports AMI or B8ZS/B7ZS line coding
- ✓ Software or DIP switch configurable
- ✓ Internal, external, or receive recover clocking
- ✓ Also functions as a high speed point-to-point modem
- ✓ Compatible with desktop models 2710 and 2720
- ✓ Made in USA

T1 termination application



SPECIFICATIONS

WAN Speed: 1.544 Mbps
WAN Connection: RJ-48C
Nominal Impedance: 100 Ohms
DTE Interface: EIA-530, V.35, X.21, Ethernet
Line Coding: AMI/B8ZS

Line Framing: D4/ESF/Unframed
Clock Options: Internal, external, or network
Diagnostics: Responds to CO-initiated D4 loop-up and loop-down codes, ESF line loop and payload loop FDL messages, and Universal Loopback de-activate messages

Transmit LBO: Selectable—0, 7.5, 15, or 22.5 dB, plus DSX-1
Standards: AT&T TR62411, TR64016, and ANSI T1.403
Test Modes: Initiates and responds to V.54 and CSU remote loops; local loop

Pattern Generator/Detector: User selectable 511, 2047, or QRSS
Dimensions: 0.78H x 2.1W x 3.5D in. (2.0H x 5.3W x 8.9D cm)

ORDERING INFORMATION

- 2710RC/B/B: Powered T1/FT1 CSU/DSU Card; EIA-530 Interface
- 2710RC/A/I: Powered T1/FT1 CSU/DSU Card; V.35 Interface
- 2710RC/D/V: Powered T1/FT1 CSU/DSU Card; X.21 Interface
- 2710RC/I/A: Powered T1/FT1 CSU/DSU Card; 10Base-T Interface

visit us online
www.patton.com

FAST Delivery From Your AUTHORIZED DISTRIBUTOR!



MicroLink™ CSU/DSU

Model 2400

Tiny 56/64 kbps CSU/DSU fits into the tightest spaces!

The Model 2400 MicroLink™ supports 64 kbps Clear Channel™ and 56 kbps DDS sync communication over two twisted-pair wires.

Available with either an M/34 (V.35) or DB-25 (RS-232) connector, the Model 2400 plugs directly into your DTE port. Clocking can be set for internal, external, or receive recover (network). Diagnostics include CSU loop and V.54 (respond) loop.

SPECIFICATIONS

DDS Type: Dedicated, 56 or 64 kbps
Transmission Format: Synchronous
DTE Interface: RS-232 or V.35
Transmission Line: 4-wire, RJ-48S

Standards: AT&T 62310 compliant
Indicators: ER (error) and TM (test mode)
Max Distance: 3.4 mi. (5.4 km) on 26 AWG (0.4mm)

Connectors: DB-25 (RS-232) or M/34 (V.35)
Clocking: Internal (master), external (slave), receive recover (network), campus
Power Supply: External AC adapter

Diagnostics: V.54 loop (respond only), CSU loop
Dimensions: 3.55 x 2.1 x .78 in. (9.0 x 5.3 x 1.9 cm) RS-232 version



FEATURES & BENEFITS

- ✓ Plugs directly into a router—just like an adapter cable!
- ✓ Operates over 56 kbps DDS, 64 kbps Clear Channel™, or private
- ✓ Your choice of V.35 (M/34) or RS-232 (DB-25) versions
- ✓ Selectable clocking: Internal (Master), External (DTE), or Receive Recover (Network)

ORDERING INFORMATION

- 2400/AM/120:** MicroLink (RS-232, DB-25 male, 120 VAC power)
2400/AF/120: MicroLink (RS-232, DB-25 female, 120 VAC power)
2400/CM/120: MicroLink (V.35, M/34 male, 120 VAC power)



G.703/G.704 Network Termination Unit (NTU)

Models 2701 & 2701RC

These devices, available in low-cost standalone or rack-mountable versions, terminate G.703/G.704 lines and provide E1/Fractional-E1.



One of the smallest and most economical NTUs available, the Model 2701 is designed with features usually found in more expensive units: flexible clocking modes, AMI/HDB3 coding, V.52/V.54 diagnostics, and user-selectable nx64 kbps data rates.

The NTUs terminate G.703/G.704 services for all nx64 kbps rates and connect to the customer's router, FRAD, CODEC, and switches with a V.35, X.21, EIA-530, or 10Base-T Ethernet interface.

The Model 2701 series terminates E1/FE1 services for all nx64 kbps to 2.048 Mbps rates and connects to a router, FRAD, CODEC, or LAN with V.35, X.21, EIA-530, or 10Base-T interfaces. Front panel LEDs and switches allow for instant diagnostics and service monitoring. Convenient DIP switches support quick and concise configuration of your E1 termination. AC or DC power options make installing the Model 2701 into your network infrastructure a snap.

Today's customers require low-cost network solutions that deliver high speed connections to the Internet and corporate intranets while supporting video-conferencing and many other wide-area services. The NetLink Models 2701 and 2701RC E1/Fractional E1 NTUs satisfy those needs.



FEATURES & BENEFITS

- ✓ Terminates E1/Fractional-E1 service
- ✓ nx64 kbps data rates to 2 Mbps
- ✓ X.21, V.35, EIA-530, and Ethernet bridge options
- ✓ Switch-selectable AMI or HDB3 line encoding options
- ✓ Switch-selectable DTE/DCE modes for X.21 version
- ✓ 75-ohm dual coax and 120-ohm twisted-pair G.703 connections
- ✓ Local and remote loopback diagnostics
- ✓ Internal, external and G.703 network timing
- ✓ Conforms to ONP requirements CTR 12 and CTR 13 for connection to international Telecom networks

Model 2701R version is also available in a rugged metal case for easy closet mounting



Models 2701 & 2701RC application: Connecting branch office to headquarters with 2701/I EtherRocket and remote router porting



Models 2701 & 2701RC application: E1 network termination on X.21 or V.35 for data



The Model 2701/D (X.21 version) provides DTE/DCE functionality in the same standalone or rack-mount package. This added versatility supports operation in X.21 DTE applications (see diagram above) where an NTU is needed to terminate G.703/G.704 and provide X.21/V.11 data to a multiplexer.

The diagram below shows how two Patton E1-EtherRockets can be used to link two Ethernet LANs over an E1/FE1 link. Each E1 EtherRocket connects to the local Ethernet LAN and build a table of local hosts on that network. If an Ethernet message is not for a local host, the bridge forwards it over the WAN to the remote

bridge. In this configuration, a user in one of the LAN segments is able to access any host and any application at the far end LAN, as easy as a local LAN connection.

Models 2701 & 2701RC application: LAN-to-LAN over E1 without a router

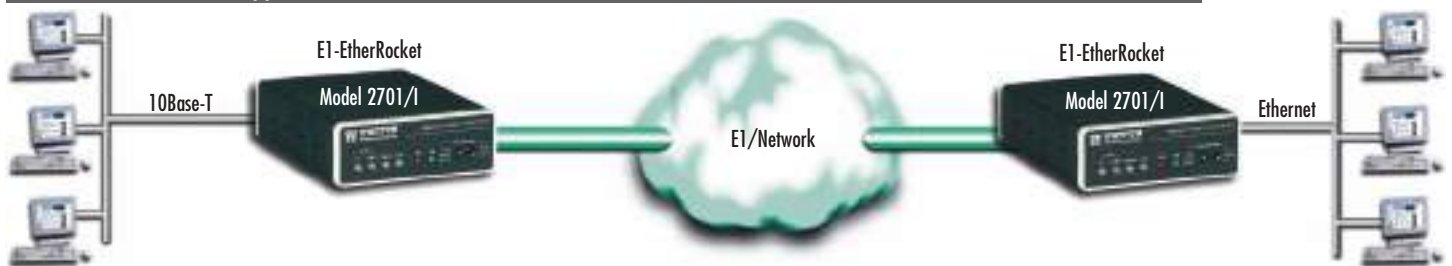

Check it out...No routers!

SPECIFICATIONS

- Data Rate:** Smooth clock 2.048 Mbps
- Network Connector:** RJ-48C (all versions); Dual coaxial (X.21 and Ethernet)
- DTE Interface:** EIA-530, X.21/V.11, V.35, or 10Base-T Ethernet
- Line Coding:** AMI or HDB3
- Line Framing:** G.703 (unframed) or G.704/G.732 (framed)
- Clocking:** Internal, external or receive recover
- DTE Rates:** nx64kbps (EIA-530, X.21/V.11, V.35); 10Mbps (10Base-T)
- Indicators:** E1 Link Status, TD, RD, Loss of Sync, Error, Test Mode, Ethernet Status (on 10Base-T Version)
- Diagnostics:** Local/remote loop, 511 Line Isolation: 1500 VRMS
- Compliance:** CE Mark, G.703, G.704, G.723, G.832, CTR-12 and CTR-13
- Temperature:** 32–122°F (0–50°C)
- Rel. Humidity:** 5–90% non-condensing
- Dimensions:**
Standalone unit
5.84L x 4.16W x 1.51H in.
(14.84L x 10.6W x 3.84H cm)
Rack card
3.0H x 0.83W x 7.84D in.
(7.6H x 2.1W x 19.0D cm)
Weight:
Standalone unit: 2.225 lbs (1.02 kg)
Rack card: 0.31 lbs (0.14 kg)

ORDERING INFORMATION

Standalone NTU, Universal 100–240 VAC Supply

- 2701/B/UI: EIA-530 (DB-25F) interface
- 2701/C/UI: V.35 (M/34F) interface
- 2701/D/UI: X.21 (DB-15F) interface
- 2701/I/UI: 10Base-T (RJ-45F) interface

Standalone NTU, -48 VDC Supply

- 2701/C/48: V.35 (M/34F) interface
- 2701/D/48: X.21 (DB-15F) interface
- 2701/I/48: 10Base-T (RJ-45F) interface

Rack card NTU

- 2701RC/A/I: RJ-45 line and V.35 (M/34F) DTE interfaces
- 2701RC/B/B: RJ-45 line and RS530 (DB-25F) DTE interfaces
- 2701RC/D/D: Dual BNC line and X.21 (DB-15F) DTE interfaces
- 2701RC/D/V: RJ-45 line and X.21 (DB-15F) DTE interfaces
- 2701RC/C/IA: RJ-45 line and Ethernet/10Base-T (RJ-45F) interfaces

visit us online
www.patton.com

FAST Delivery From Your AUTHORIZED DISTRIBUTOR!





See
Pg 228

MicroPak™ G.703 Interface Converter

Model 2702

This MicroPak™ interface converter provides unstructured, clear-channel, 2-Mbps G.703 applications in a small package.

The Model 2702 fits into environments where high speed E1/G.703 services are being offered to customers with routers/FRADs and other networking devices. These G.703 interface converters convert signals from the unstructured, clear channel, synchronous line interface—delivered by the carrier—to a 2-Mbps digital interface required by the users' networking equipment.

To accomplish this, the Model 2702 presents a RJ-48C interface to the line and a V.35 interface to the customer's device. The V.35 interface is presented using a male M/34 connector. Line coding and clock options may be selected using internally accessible DIP switches.



If other interfaces are required, the user may select our Model 2703 converter which presents the following interfaces: X.21, RS422/530, V.36/RS449 and V.24/RS232. These interfaces are delivered through a standard interface cable which connects to the female DB-25 on one end and the desired interface on the other. If other DTE speeds are necessary, our Model 2094 connects Fractional E1 at nx64 speeds up to 2 Mbps.

FEATURES & BENEFITS

- ✓ Converts unframed 2-Mbps G.703 to synchronous V.35
- ✓ Integral V.35 (M/34) male connector (60-pin Cisco router adapter cable also available)
- ✓ V.54 compliant loopback diagnostics with built-in QRSS, 511 and 2047 test pattern generator
- ✓ Easy-to-read LEDs for TXD, RXD, ALM, LOS, TST, and ERR
- ✓ AMI or HDB3 line coding
- ✓ Configuration via DIP switches
- ✓ External 90–260 VAC power supply



I'm Seán, Patton's Director of Sales for North America & Japan. Call me at +1 301.975.1000 when you want to purchase Patton products or if you have questions about our products. You can also send e-mail to sales@patton.com.

Typical Model 2702 application



ORDERING INFORMATION

2702/CM/UI: Micro-Pak Version. Clear Channel E1 Access Converter (V.35, M/34 male)

SPECIFICATIONS

Network (line) connector: 8-position RJ-45 connector

Nominal impedance: 120-ohm; 75-ohm available with Model 460 Balun

Network (line) data rate: 2.048 Mbps in accordance with ITU-T G.703

DTE interface: Integral V.35 (M/34 male)

DTE rate: 2.048 Mbps

Line encoding: Selectable for AMI or HDB3

LED indicators: Transmit data (TXD), receive data (RXD), alarm (ALM), test mode (TST), loss of sync (LOS), error (ERR)

Line framing: G.703 clear channel

Clocking: Selectable internal or network (receive recover) clock

Diagnostics: V.54 complaint loopbacks; built in QRSS, 511 and 2047 test pattern generator and detector with performance monitoring

Standards: Fully compliant with ITU-T G.703

Approvals: FCC Part 15, Class A; CE Mark per EMC Directive 89/336/EEC and Low Voltage Directive 73/23/EEC; Canadian DOC; BABT

Power supply: 100–240 VAC, 50/60 Hz universal input; -48 VDC optional (10 watts)

Dimensions: 9.0 x 5.3 x 1.9 cm (3.5 x 2.1 x 0.78 in.)

Weight: 0.11 kg (0.25 lb.)

Extend T1/E1 Over Copper

Extending your T1 lines over copper is easy with the Patton Model 2115, and just as easy over E1 with the Model 2113.



See page 14

MegaLink-I™ 2 Mbps G.703 Access Converter

Model 2703

Convenient network terminator, interface converter, and rate adapter...All in one box!

The Model 2703 MegaLink-I™ performs several tasks: network termination unit (NTU), interface converter, and rate adapter.

As an NTU, the Model 2703 receives unstructured, synchronous 2.048 Mbps data from a G.703 network and sends it to a router, bridge, multiplexer or other device.

As an interface converter, the Model 2703 accepts 120-ohm twisted pair or 75-ohm dual coax network connections (both types of interfaces are provided). Then it converts the signals to EIA-530 (V.36/RS-422), V.35 or X.21 formats (switchable) on a UD-26 connector.

As a rate converter, the Model 2703 lets a lower bandwidth device—256 kbps, 512 kbps, or 1.024 Mbps—connect to



a 2.048-Mbps G.703 link. The Model 2703 supports internal, external or network (receive loop) clocking. A loopback test is built-in, and front panel LEDs monitor power, network, master clock and test loop. Several power supply options and convert cables are available, call for details.

FEATURES & BENEFITS

- ✓ Network data rate of 2.048 Mbps
- ✓ Four selectable DTE Data Rates
- ✓ Supports V.35, RS-530 (V.36/RS-422) or X.21 terminals
- ✓ 75-ohm and 120-ohm network terminations
- ✓ Internal, external or network (receive loop) clocking

Rack card

The Model 2703RC is a 2U (3.5-inch) high rack card version of the MegaLink-I™. Built around Patton's midplane architecture, the Model 2703RC combines a front function card with a choice of two rear interface cards (120 ohm with RS-530, or 75 ohm with X.21). The Model 2703RC fits in Patton's rack chassis or ClusterBoxes™. One AC or DC power supply card provides power to up to 16 Model 2703RC converters. The Model 2703RC incorporates all basic MegaLink-I™ features, except rate adaptation.



Local ISP with multiple G.703/E1 upstream links

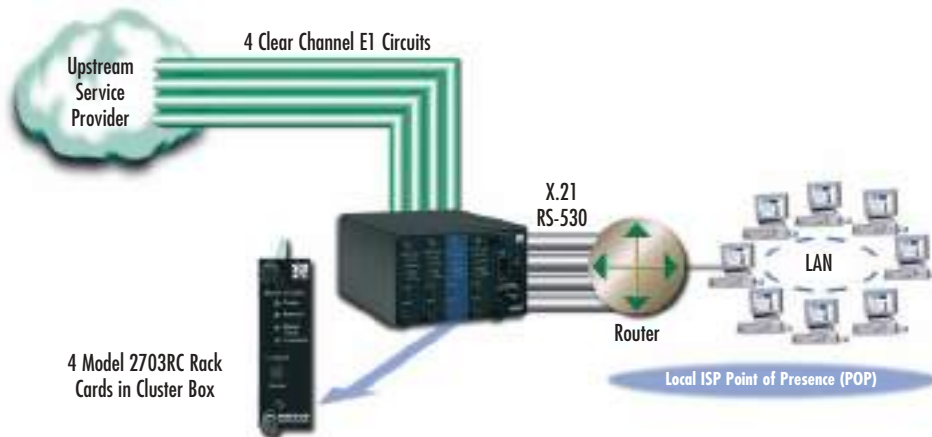

OEM Module

At the heart of the MegaLink-I™ is Patton's IM703 G.703/E1 interface module. The IM703 module provides both 75-ohm (dual-coax BNC) and 120-ohm (RJ-45 twisted pair) 2.048-Mbps network connections in one compact daughterboard. Patton's IM703 module is also available separately for OEM applications.

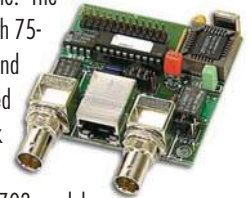

ORDERING INFORMATION

Universal interface version (UD-26)

2703/120: 120 VAC

2703/230: 230 VAC

2703/UI: 90–260 VAC

2703/DC: -48 VDC

X.21 only version (DB-15F)

2703-X.21/120: 120 VAC

2703-X.21/230: 230 VAC

2703-X.21/UI: 90–260 VAC

2703-X.21/DC: -48 VDC

Rack card

2703RC-A/A/45: V.35 (DB-25); RJ-48C

2703RC-A/A/CX: V.35 (DB-15); Dual Coax

2703RC-A/B/45: RS-422 (DB-25); RJ-48C

2703RC-A/B/CX: RS-422 (DB-25); Dual Coax

2703RC-A/C/45: X.21 (DB-15); RJ-48C

2703RC-A/C/CX: X.21 (DB-15); Dual Coax

SPECIFICATIONS

Network Interface: G.703

Network Rate: 2.048 Mbps

Network Connectors: Two BNC

(75 ohm) and one modular

RJ-45 connector (120 ohm)

Terminal Interface: RS-530

(V.36/RS-422), V.35 or X.21 on UD-26

(V.35 not available on rack cards)

Terminal Rate: 2.048 Mbps (all

models); 1.024 Mbps, 512 kbps, 256

kbps (standalone only)

Diagnostics: Loopback test

Indicators: LEDs for power, network, master clock and loop

Clocking: Internal, external, network

(receive loop)

Receiver Sensitivity: -10 dB

(0 dB = 2.4V)

Power: 120/240 VAC (switch selec-

table), 50/60 Hz; 100–240 VAC, 50/60 Hz

(universal input option); 48 VDC (optional)

Dimensions: 7.3 x 6.6 x 1.62 in.

(18.5 x 16.7 x 4.1 cm)



See
Pg 226

Lowest Cost G.703 Network Termination Unit (NTU)

Model 2707

This device terminates G.703 lines and provides serial and 10Base-T interface conversion.

Today's customers require low-cost network solutions that deliver high speed connections to the Internet and Corporate Intranets while supporting videoconferencing and many other wide-area services. The NetLink Model 2707 E1 NTUs satisfies those needs.

The NTUs terminate G.703 and connect to the customer's router, FRAD, CODEC, and switches with a V.35, X.21, or 10Base-T Ethernet interface.



FEATURES & BENEFITS

- ✓ Terminates E1 services
- ✓ Available in low-cost standalone or rack-mountable (2707RC) versions
- ✓ 2 Mbps data and line rate
- ✓ X.21, V.35, and Ethernet bridge options
- ✓ Switch-selectable AMI or HDB3 line encoding options
- ✓ Switch-selectable DTE/DCE modes for X.21 version
- ✓ 75-ohm dual coax and 120-ohm twisted-pair G.703 connections
- ✓ Local loopback diagnostics
- ✓ Internal, external and G.703 network timing
- ✓ CE approved
- ✓ UI (100–240 VAC) 120/230 VAC & 48 VDC power options
- ✓ Conforms to ONP requirements CTR 12 for connection to international telecom networks
- ✓ 1 mile (1.6 km) distance

E1 network on X.21 or V.35 for data



The Model 2707/D (X.21 version) provides DTE/DCE functionality in the same standalone or rack-mount package. This added versatility supports operation in X.21 DTE applications (see diagram above) where an NTU is needed to terminate G.703 and provide X.21/V.11 data to a multiplexer.

Our Ethernet version, the Model 2707/I offers 10Base-T bridging with PPP support. This enables customers to extend a router's serial interface and connect to a remote 10Base-T Ethernet LAN (see below). The 2707/I uses MAC learning and forwarding to provide seamless LAN-to-LAN connectivity.

SPECIFICATIONS

Data Rate: Smooth Clock 2.048 Mbps
Network Connector: RJ-48C (all versions); Dual Coaxial (X.21 and Ethernet)
Line Coding: AMI or HDB3
DTE Interface: X.21/V.11, V.35, or 10Base-T Ethernet
Line Framing: G.703 (unframed)
Clocking: Internal, External or Receive Recover

Diagnostics: Local Loop
Line Isolation: 1500VRMS
Compliance: CE Mark, G.703, and CTR-12
Op. Temp.: 32–122°F (0–50°C)
Humidity: 5–90% non-condensing
Dimensions: 5.84L x 4.16W x 1.51H in. (14.84L x 10.6W x 3.84H cm)
Weight: 2.225 lbs (1.02 kg)

E1 network on X.21 or V.35 for data

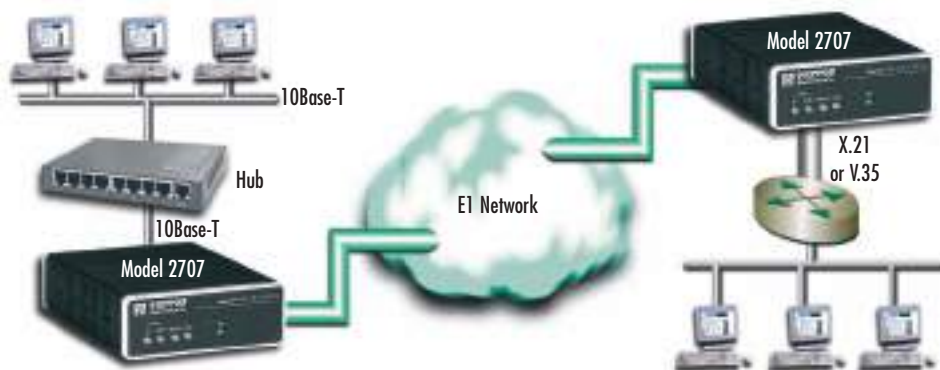

ORDERING INFORMATION

G.703 Interface Converter

2707/C/UI: G.703 to V.35, 100–240 VAC

2707/D/UI: G.703 to X.21, 100–240 VAC

2707/I/UI: G.703 with 10Base-T interface 100–240 VAC

2707/C/48: G.703 to V.35, 48 VDC

2707/D/UI: G.703 to X.21, 48 VDC

2707/I/UI: G.703 with 10Base-T interface 48 VDC

2707RC/A/I: Rack G.703 to V.35

2707RC/D/D: Rack G.703 to X.21

2707RC/C/IA: Rack G.703 with 10Base-T interface



MicroLink-E1™ E1/FE1 Nx64 CSU/DSUs
Model 2715

Miniature NTU terminates framed or unframed 2-Mbps E1/FE1 (G.703/G.704) circuits.

The Patton Model 2715 Network Termination Unit (NTU) terminates 2.048-Mbps E1 (clear channel) and fractional E1 (nx64) 4-wire circuits. Housed in our MicroPak enclosure, the Model 2715 plugs directly into the V.35 DTE interface of a router, switch, FRAD, multiplexer, or other networking device.

The Model 2715 supports all necessary G.703/G.704 diagnostics, including CO line loopback (LLB), payload loopback (PLB), DTE local/remote loops, and V.54 loop up/loop down. Diagnostics are initiated via the Model 2715's control port, or through the DTE or line interfaces. Easily readable LED indicators include TD, RD, Loss of Sync (LOS), Alarm, Error, Test and Power.



Configuration of the Model 2715 standalone is done through the control port or using DIP switches. (The Model 2701RC rack card is configured through the control port or SNMP.)

Model 2715 presents a RJ-45 120-ohm interface to the line and a V.35 interface to the customer's device using a male M/34 connector (the Model 2701RC rack card is available with a female M/34). An M/34 to DB-60 adapter cable is available for convenient connection to Cisco routers. The Model 2715 is powered by an external universal input 100–240 VAC adapter.

FEATURES & BENEFITS

- ✓ Terminates 2.048 Mbps E1 (clear channel) and FE1 (nx64) 4-wire digital services
- ✓ Built-in V.35 (M/34) male connector (DB-60 Cisco router adapter cable is available)
- ✓ Standalone (Model 2715) and rack mount cards (Model 2707RC) are available
- ✓ Diagnostics include LLB and PLB; DTE local and remote loops; V.54 loop up and loop down
- ✓ AMI or HDB3 line coding
- ✓ Configuration via DIP switches or control port
- ✓ External 90–260 VAC power supply



Rack card units available, see Network Access Catalog for details

Typical application

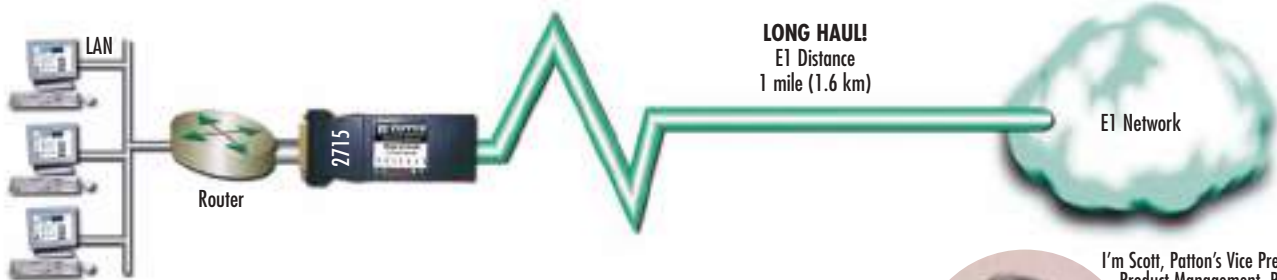

Also available with DB-60 cable for Direct Connection to Cisco Routers.



I'm Scott, Patton's Vice President of Product Management. Patton has put together the following resource listing for companies interested in this technology. If you don't find the answers you need at www.patton.com, please call me at +1 301.975.1000 x166. You can also send e-mail to support@patton.com.

SPECIFICATIONS

WAN connection: 8-position connector (RJ-45)
Nominal impedance: 100 ohm
WAN speed: 2.048 Mbps
DTE interface: Integral V.35 (M/34 male)
Line coding: E1—AMI/HDB3
Receive LBO: Automatic

Transmit LBO: Selectable—0, 7.5, or 15 dB
Clock options: Internal, external, and network clock
Diagnostics: Respond to CO line loopback (LLB) and payload loopback (PLB) via control port and DTE initiate remote LLB and remote PLB (all loops are bi-directional with respect to the DTE);

DTE local and remote loops (bi-directional); V.54 loop-up/loop-down as detected in the data stream
Standards: G.703/704, G.732
Power: 120 VAC, 60 Hz to 5VDC 300mA wall mount transformer or UI 100–240VAC, 50 Hz to 5 VDC, 3A wall mount transformer

Resources Available By Request
G.703/704 Powerpoint E1 Course Materials
Remote Router Porting (RRP) with E1 white paper

On-Line Resources
G.703 Products Brochure
Product Data Sheets
User Manuals

ORDERING INFORMATION

- 2715/CM/UI:** MicroLink-E1™ E1/FE1 Nx64 CSU/DSU (V.35, M/34 male, universal input power supply)
- 2715/CM/48:** Stand alone NTU; V.35 (M/34F) interface; -48 VDC supply

visit us online
www.patton.com

FAST Delivery From Your AUTHORIZED DISTRIBUTOR!



Integrated TDM & IP Routers

IPLink™ 2620

Link up effortlessly with the Patton Model 2620 Dual-Port T1/E1 IPLink Router combines two T1/E1 and four 10/100 Ethernet ports to deliver drop and insert and WAN bandwidth to the most demanding access applications.



This dual-port T1/E1 router is a versatile access router supporting drop and insert T1/E1 applications as well as high-speed WAN IP network access.

Combining ease-of-use with a full suite of LAN/WAN routing features, the Model 2620 provides selectable bridging or routing functionality along with advanced IP features such as NAT/NAPT, DNS relay, and DHCP server and relay. Numerous firewall features, including the ability to filter by IP address and by IP port, support for Intrusion Detection (IDS), and the capability of "blacklisting" offending traffic flows, likewise come standard with the unit.

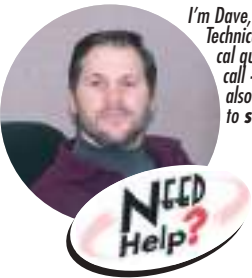

I'm Dave, Patton's Manager of US Technical Support. If you have technical questions or comments, please call +1 301.975.1007. You can also send e-mail to support@patton.com.

A complete set of configurable FR/PPP/IP WAN protocols allow a wide range of choices when connecting equipment via common WAN services. By supporting the latest version of PPP/BCP, the IPLink transparently negotiates the passing of VLAN traffic. Deployments can also take advantage of the Model 2620's full implementation of Frame Relay to support Frame Relay VPN deployments over switched carrier networks.

The Model 2620 boasts easy installation offering Console/VT-100, Telnet, and HTTP/SNMP management options. All IPLink Routers come with a four port auto-sensing full-duplex 10/100Base-T Ethernet switch, the choice of internal or external power supply and two T1/E1 WAN ports with built in CSU/DSU.

Patton's series of high-speed access routers offer the versatility and reliability demanded for business-class applications at the most affordable price.

SPECIFICATIONS

WAN ports: Two software configurable ports. E1—G.703/G.704 with HDB3 and AMI encoding support. T1—ANSI T1.403 & AT&T TR54016 with AMI coding/D4 framing or B8ZS coding/ESF framing

Ethernet Ports: Four port 10/100Base-T (RJ-45 connector) • auto-negotiating • half or full duplex operation with built-in MDI-X

Protocols: IP (RFC 741), TCP (RFC 793), UDP (RFC 768), ICMP (RFC 950), ARP

(RFC 826) • IP Router with RIP (RFC 1058) and RIPv2 (RFC 2453), integrated DHCP Server (RFC 2131) with selectable IP leases and MAC/IP pairings • DHCP relay agent (RFC 2132/RFC 1542) with 8 address pools • DNS Relay, IGMP v1 and v2, Ethernet Bridging • NAT/NAPT with integrated application support, MultiNat with 1:1 mapping, Many:1, Many:Many mapping, NAT Port/IP redirection and mapping

Management: HTTP/SNMP, Telnet, Ethernet, RS-232 Console Port, SYSLOG Client, Software upgrade via TFTP, SNMP
Security: DoS Detection/protection • Intrusion detection, Logging of session, blocking of intrusion events and Real-Time alerts, Password protected system management with a username/password for console and virtual terminal, Packet filtering firewall for controlled access to and from LAN/WAN, Support for 255 rules in 32 filter sets, 16 individual connection

Power: Internal universal 90–260 VAC input or 48 VDC input.

Compliance: FCC Part 15A, CE Mark, EMC Directive 89/336/EEC, Low-Voltage Directive 73/23/EEC, EN60950, EN55022 (CISPR 22) • FCC part 68

Environment: Temp.: 0–50°C (32–122 °F) • Humidity: 5–90% non-condensing

Dimensions: 7.3 x 6.6 x 1.62 in. (185 x 168 x 41 mm)

FEATURES & BENEFITS

- ✓ Dual T1/E1 with Drop & Insert—Easily take any DSO from one T1/E1 port and switch it to the other.
- ✓ Four 10/100 Ethernet—Easily bridge the gap between the LAN and WAN.
- ✓ Terminate nx64 data, Frame Relay, or PPP encapsulated IP traffic on channelized interfaces.
- ✓ Enhanced IP Services—DNS relay, NAT/NAPT, DHCP server and relay, make it easy to offer any service.
- ✓ Firewall with Standard DoS & Filtering—Built-in IP address and IP port filtering, intrusion detection and blacklisting capabilities make firewall services a snap.

ORDERING INFORMATION

2620/KK/EUI: E1 Router, D&I port, Quad 10/100 Ethernet, 90–260 VAC PS

2620/TT/EUI: T1 Router, D&I with Quad 10/100 Ethernet, 90–260 VAC PS

2620/KK/48: E1 Router, D&I port, Quad 10/100 Ethernet, internal 36–72 VDC PS

2620/TT/48: T1 Router, D&I with Quad 10/100 Ethernet, internal 36–72 VDC PS

Typical Internet Application

With Dual T1/E1 ports, the IPLink Model 2620 maximizes the use of the up-link network and minimizes the cost of deploying the service by implementing Drop & Insert of DSO channels between the T1/E1 ports. The remaining bandwidth can then be used to provide other value added IP access services or even LAN extension over any of the four 10/100 Ethernet ports. For bandwidth hungry applications, traffic from both T1/E1 ports can be bonded together using multi-link PPP.

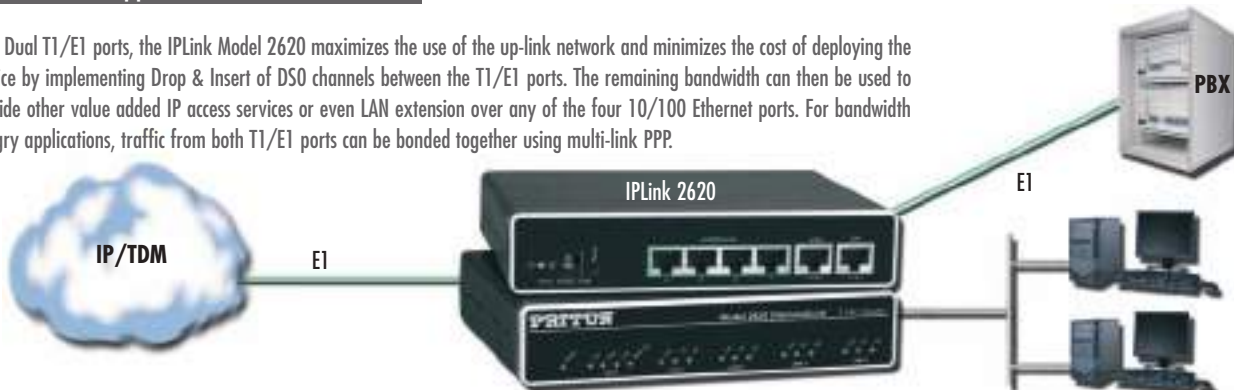

See
Pg 226



Co-directional G.703 Converters

Model 2070



Plug-in access converter for G.703/64 kbps.

The Model 2070 Series interface converters allow a router—or similar WAN device—with a V.24 (RS-232), V.35 or X.21 port to connect to a G.703/64k co-directional (PCM) network.

All versions come with an RJ-45 jack for 120-ohm twisted-pair network termination (termination to a 75-ohm network can be accomplished using the Patton Model 460 balun).

Model 2070 Series converters incorporate local loopback and G.703 loopback diagnostic modes. Diagnostic modes are controlled by a switch, or by the local DTE (V.24 or V.35 versions only). Synchronous clock jitter is attenuated in accordance with the G.823 specification. For protection against ground loops and transient surges, the Patton Model 2070 Series converters incorporate both transformer isolation and surge protection.

SPECIFICATIONS

G.703 Interface: Symmetrically balanced pairs, 4 wire, 120 ohm terminated to female RJ-45

Operating Speed: Co-directional timing, Rx recovered: 64 kbits + 500ppm.

Clocking: Internal, External or Net Timing

G.703 Input Signal Level: 2.0V differential, into 120 Ohms, nominal.

Max. Cable Loss: 0 to -10dB

Line Encoding: AMI

Jitter Perf.: CTR 14, G.823

Surge Prot.: Device Response Time—100ns; Clamp Volt.—8.5V ±1V.

Power: 5VDC at 300mA, supplied by external transformer or on these DTE pins: pin 9 (V.24), pin KK (V.35), pin 15 (X.21)

Isolation: 1500 VRMS, XFMR coupled.

Temp.: 32–140°F (0–60°C)

Dimensions: 2070/AM: 4.90x2.00x0.73 in. (12.45x5.08x1.85 cm); 2070/CM & 2070/DF: 3.40x2.00x0.73 in. (8.63x5.08x1.85 cm)

FEATURES & BENEFITS

- ✓ Bi-directionally converts V.24 (DB-25), X.21 (DB-15), or V.35 (M/34) to G.703/64 kbps co-directional
- ✓ Synchronous operation at 64 kbps
- ✓ Internal, external, or network clocking options
- ✓ Point-to-point distance up to 5,250 ft (1600 m) on 24 AWG (0.5mm) twisted pair
- ✓ Complies with CCITT/ITU G.823 jitter control specifications

ORDERING INFORMATION

G.703/64 kbps Interface Converter

2070/AM/UI: RS-232, DB-25 male, universal input power

2070/CM/UI: V.35, M/34 male, universal input power

2070/DF/UI: X.21, DB-15 female, universal input power

Typical application

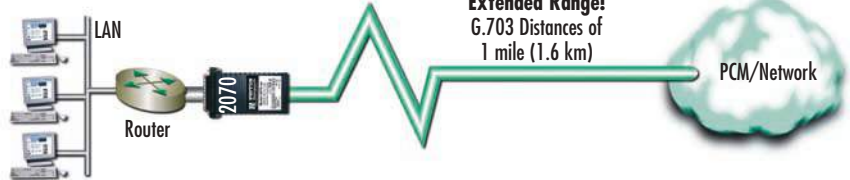

G.703/64-kbps Interface Converter

Model 2073

Standalone PCM converter supports Patton's QuikConnect™ modules.



The Patton Model 2073 KiloLink™ G.703/64 kbps co-directional access converter lets bridges, routers, switches, multiplexers, and other WAN hardware connect to a KiloStream™ or similar G.703 circuit. Operating in either clear channel or octet timing modes, the Model 2073 offers three clocking options and seven front panel LED status indicators. Built-in transformer isolation and surge protection guard the Model 2073 and connected hardware against data line transients and ground loops.

SPECIFICATIONS

G.703 Interfaces: 64 kbps, symmetrically balanced, 4-wire pair, 120-ohm terminated to a female RJ-45

DTE Interface: V.24/RS-232, V.35, X.21, G.703, Data+Voice, Ethernet Bridge

Data Rates: V.110 rate adaptation for asynchronous data rates from 50 bps to 57.6 kbps, and for synchronous data rates from 500 bps to 64 kbps

Operating Modes: 256 kbps rate co-directional timing, Rx recovered; 64 kbps+500ppm (clear channel); or with BPV for octet timing mode to communicate over a 128-kbps link (preservation of byte integrity)

Diagnostics: local analog loopback, remote digital loopback, V.52 compliant bit error rate pattern (511/511E pattern) generator & detector with error injection mode

Line Coding: AMI

Clocking: Internal, external, or network clock

G.703 Input Signal Level: 0 to -10 dB, 2V differential, nominal

Jitter Performance: CTR14, G.823

Isolation: Minimum 3000V RMS via custom transformers

Surge Protection: 600W power dissipation

Range: 0.5 mile (0.8 km)

Power: 100–240 VAC, 50/60 Hz (universal input option); 48 VDC (option); 5 watts

Dimensions: 7.3 x 6.6 x 1.62 in. (18.5 x 16.8 x 4.1 cm)

Weight: 2.02 lbs (0.92 kg)

FEATURES & BENEFITS

- ✓ Switchable internal, external, or network clocking options
- ✓ Supports synchronous data rates of 9.6 to 64 kbps
- ✓ Supports asynchronous data rates of 9.6 to 19.2 kbps
- ✓ Clear channel or octet timing
- ✓ Accepts Patton QuikConnect modules
- ✓ Internal power supplies, 100–240 VAC, or -48 VDC

ORDERING INFORMATION

G.703/64 kbps Interface Converter

2073/A/UI: V.24, DB-25F, 100–240 VAC power

2073/B/UI: RS-422/530, DB-25F, 100–240 VAC power

2073/C/UI: V.35, M/34F, 100–240 VAC power

2073/D/UI: X.21, DB-15, 100–240 VAC power

2073/E/UI: Ethernet, RJ-45, 100–240 VAC power

Typical application



Interface & Media Converters

Miniature



Stand Alone



Rack Mount



Industrial Communications Converters

Pages 178-183

RS-232 ↔ RS-422
 RS-232 ↔ TTL
 RS-232 ↔ RS-485
 RS-232 ↔ Current Loop
 RS-232 ↔ Ethernet

RS-232 ↔ Ethernet
 RS-422 ↔ Ethernet
 RS-485 ↔ Ethernet

RS-232 ↔ RS-422
 RS-232 ↔ RS-485
 RS-232 ↔ Current Loop

Wide Area Network Converters

Pages 172-177

V.35 ↔ RS-530
 V.35 ↔ RS-449
 V.35 ↔ X.21
 RS-232 ↔ V.35
 RS-232 ↔ X.21
 RS-232 ↔ V.36
 HSSI ↔ V.35
 HSSI ↔ X.21
 HSSI ↔ RS-422/530
 HSSI ↔ E1
 Async ↔ Sync

RS-232 ↔ V.35
 RS-232 ↔ X.21
 Async ↔ Sync

RS-232 ↔ V.35
 V.35 ↔ X.21

Printer Converters

Pages 186-187

Serial ↔ Parallel
 RS-232/423 ↔ IEEE-1284

Parallel ↔ Serial Buffer

T1/E1 Converters

Pages 158-169

64K/G.703 ↔ X.21, V.35 or RS-232
 G.703/G.704 ↔ V.35
 T1 ↔ V.35
 E1 ↔ HSSI

64K/G.703 ↔ V.21, V.35 or RS-232
 G.703/G.704 ↔ V.35
 T1 ↔ V.35
 E1 ↔ HSSI

Page 177

64K/G.703 ↔ X.21, V.35 or RS-232

We're out to convert you

Cost-Effective Media Converter Solutions

Copper to Ethernet Converter

Page 57



RS-232 to Ethernet Server

Page 183



MicroBridges

Page 183

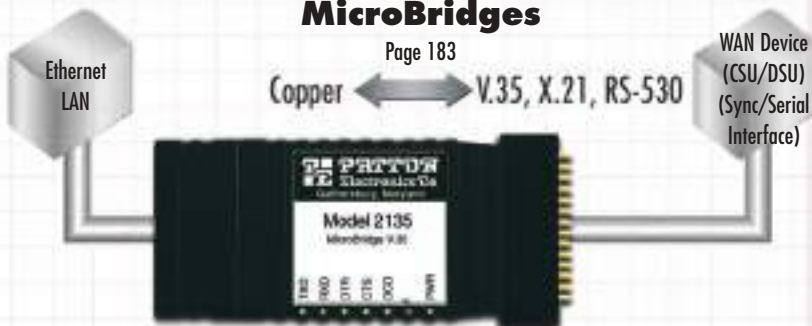

In This Section

Wide Area Network Converters 172

RS-232 Async. to Sync. Converters	172
Passive RS-530 to V.35 Converter	172
Passive RS-449 to V.35 Converter	173
Mini X.21 to V.35 Converter	173
RS-232/V.35 to X.21 Converter Rack Cards	173
Passive RS-232 to V.35 Converters	174
RS-232 to V.35 Converter Rack CARD	174
RS-232 to X.21 Interface Converter	175
RS-232 to V.36 (RS-550/449) Interface Converter	175
Micro V.35 to T1 Converter	176
Micro V.35 to G.703/G.704 (E1) Converter	176
V.35 to HSSI Converter	177
X.21 to HSSI Converter	177
RS-422/530 to HSSI Converter	177

Async./Industrial Converters 178

Interface Powered, RS-232 to RS-485 Interface Converters (with Handshaking)	178
Interface Powered, RS-232 to RS-422 Interface Converters (Transmit & Receive Data Only)	180
RS-232 to Current Loop Converters (20 or 60mA)	180
RS-232 to 20mA Current Loop Converter (DB-25 to DB-25)	180
Ethernet to RS-232 Converter/Terminal Server	183

Ethernet Micro Bridges 183

Ethernet to V.35 Converter/Bridge	183
Ethernet to X.21 Converter/Bridge	184
Ethernet to V.24 Converter/Bridge	184
Ethernet to EIA-530 Converter/Bridge	184
Auto-Directional Serial to Parallel Converters	185
Compact Interface Serial to Parallel Converters	185

Printer Interface Converters/Extenders 186

Powered Serial to Parallel Printer Converter	186
RS-232/423 to IEEE-1284 Converter	186
Self-Powered Parallel Line Extenders	187
AC Powered, Parallel Short Range Modem	187

RS-232, Asynchronous to Synchronous Converters

Models 2010 & 2011

Now Asynchronous Devices Can Access Synchronous Modems & Digital Networks

The Models 2010 and 2011 async to sync converters enable asynchronous DTEs to communicate over synchronous analog or digital connections. The Model 2010 supports data rates from 150 bps to 19.2 kbps. The Model 2011 supports data rates from 19.2 to 64 kbps. Both models plug directly into a local async terminal, PC or host and connect that DTE—via RS-232 cable—to a sync modem, mux or CSU/DSU. When the same set-up is installed



on the remote end, the local and remote DTEs can communicate over the synchronous link.

Drawing power from either the sync or async RS-232 interface, the Model 2010 and 2011 need no AC power or batteries for operation. Data rates are automatically adjusted to match the sync DCE's output rate, so no data rate strapping is necessary. The Model 2010 and 2011 derive clocking externally from the synchronous DCE, and do not limit data block size.

Typical application

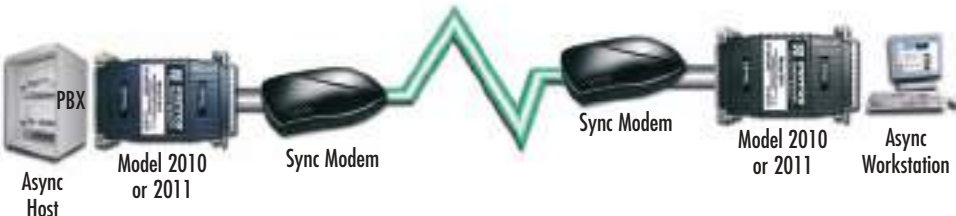

FEATURES & BENEFITS

- ✓ Model 2010 supports data rates from 150 bps to 19.2 kbps
- ✓ Model 2011 supports data rates from 19.2 to 64 kbps
- ✓ Conforms to CCITT V.22 and V.14 standards
- ✓ Synchronous data rates are adjusted automatically
- ✓ Small size—plugs directly into async or sync RS-232 port
- ✓ Accepts external clocking

ORDERING INFORMATION

2010: Async to Sync Converter

2011: High Speed (64 kbps) Async to Sync Converter

SPECIFICATIONS

Data Rates: Model 2010—150 bps to 19.2 kbps; Model 2011—19.2 to 64 kbps

Clocking: Provided by modem or multiplexer

Buffer: 4 bit RTS override feature empties buffers before dropping RTS, making the Model 2011 usable in a polling environment

Data Transmission: Full or half duplex

Connectors: DB-25 female on asynchronous port, DB-25 male on synchronous port

Op. Temp.: 32–122°F (0–50°C)

Power Supply: None required

Dimensions: 3.2" x 2.0" x 0.75" (8.1 x 5.1 x 1.9 cm)

Weight: 2 oz. (56 grams)

Passive RS-530 to V.35 Converter

Model 2014

Lets a balanced, synchronous device communicate with a V.35 controller or CSU/DSU

The Model 2014 RS-530 to V.35 converters let a synchronous RS-530 device communicate bi-directionally with a synchronous V.35 device. The Model 2014 requires no AC power or batteries to operate and supports data rates to 2 Mbps. Operating full or half duplex, the Model 2014 passes all necessary clocking and control signals, and is transparent to protocol.



The Model 2014 connects directly to the synchronous RS-530 interface using a male or female DB-25 connector. A male or female M/34 connector at the end of an integral 6 foot (1.8 m) cable attaches to the V.35 device. Models with any combination of

DTE and DCE wiring are available, thus eliminating the need for special crossover cables.

FEATURES & BENEFITS

- ✓ Bi-directionally converts synchronous RS-530 to V.35
- ✓ Supports data rates to 2 Mbps, full or half duplex
- ✓ Various DCE/DTE and gender combinations available
- ✓ DB-25 and M/34 connectors with integral 6 foot (1.8m) cable (Model 2014)

ORDERING INFORMATION

Examples

Factory Part Number Encoding

* M=male, F=female, T=DTE, C=DCE

2014 X X- X X
 V.35 DCE/DTE configuration†
 V.35 (M/34) gender*
 RS-530 DCE/DTE configuration†
 RS-530 (DB-25) gender*

Note: DCE-to-DCE and DTE-to-DTE configurations are not possible with passive units.

2014MT-MC: (DB-25 male, DTE configuration) to (M/34 male, DCE config.)

2014FC-MT: (DB-25 female, DCE config.) to (M/34 male, DTE config.)

Note: Other models available, call for details.

SPECIFICATIONS

Interfaces: EIA RS-530/RS-422 to CCITT V.35

Data Rates: Up to 2.048 Mbps

Transmission Mode: Full or half duplex

Protocol: Transparent to protocol

Clocking: Set by connected devices

Connectors: DB-25 male or female on RS-530 side, M/34 male or female on V.35 side

Op. Temp.: 32–122°F (0–50°C)

Altitude: 0–15,000 feet

Humidity: Up to 95% non-condensing

Power Supply: None required, uses ultra low power from EIA data and control signals

Dimensions: 2.66L x 2.10H x 0.73W in. (6.8L x 5.3H x 1.9W cm)

Weight: 14 oz. (400 g) including cable

Passive RS-449 to V.35 Converter

Model 2015

Synchronous RS-449/422 Devices Can Now Access V.35 WAN Hardware

SPECIFICATIONS

Interfaces: EIA RS-449/422 to CCITT V.35 Data Rates: Up to 2.048 Mbps
Transmission Mode: Full or half duplex
Protocol: Transparent to protocol
Clocking: Set by connected devices
Connectors: DB-37 male or female on RS-449/422 side, M/34 male or female on V.35 side

Op. Temp.: 0–50°C (32–122°F)
Altitude: 0–15,000 feet
Humidity: Up to 95% non-condensing
Power Supply: None required; uses power from NIC data & control signals
Dimensions: 2.66Lx2.1HxD.73W in.
Weight: 14 oz



ORDERING INFORMATION

Example

Factory Part Number Encoding

* M=male, F=female, †T=DTE, C=DCE

2015 X X X X
 V.35 DCE/DTE configuration†
 V.35 (M/34) gender*
 RS-449 DCE/DTE configuration†
 RS-449 (DB-37) gender*

Note DCE-to-DCE and DTE-to-DTE configurations are not possible with passive units.

2015MT-MC: (DB-37 male, DTE config.) to (M/34 male, DCE config.)

Note: Other models available, call for details.

Mini X.21 to V.35 Converter

Model 2016

This “converter-in-a-cable” lets sync. X.21 hardware communicate with sync. V.35 hardware

SPECIFICATIONS

Interfaces: CCITT X.21 to CCITT V.35
Data Rates: Up to 2.048 Mbps
Transmission Mode: Full or half duplex
Protocol: Transparent to protocol
Clocking: Set by connected devices
Connectors: DB-15 male or female on X.21 side; M/34 male or female, or DB-25 male or female, on V.35 side
Compliance: CE Marked per EMC Directive 89/336/EEC

Temperature Range: 32–122°F (0–50°C)
Altitude: 0–15,000 feet (0–4,572 meters)
Humidity: Up to 95% non-condensing
Power Supply: None required; uses power from NIC data and control signals
Dimensions: 2.7L x 1.5H x 0.7W in. (6.8L x 3.8H x 1.8W cm)
Weight: 14 oz (198 g) including cable and connectors



ORDERING INFORMATION

Examples

Factory Part Number Encoding

* M=male, F=female, †T=DTE, C=DCE

2016 X X X X
 V.35 configuration†
 V.35 (M/34 or DB-25) gender*
 X.21 configuration†
 X.21 (DB-15) gender*

2016MT-MC: (DB-15 male, DTE) to (M/34 male, DCE)

2016FC-FT: (DB-15 female, DCE) to (M/34 female, DTE)

Note: Many other models available, call for details.

RS-232/V.35 to X.21 Converter Rack Cards

Model 2066

Synchronous converter cards match high speed WAN interface

SPECIFICATIONS

Transmission Format: Synchronous
External Interface: Dual UD-26 high density connectors
Electrical Interface: X.21—EIA RS-422/V.11 compatible; RS-232—RS-232/V.28 compatible; V.35 data and clock signals: receivers—V.35 compliant, drivers—0.56V differential signal; V.35 control signals—RS-232/V.28 compatible
Data Rates: Up to 2.048 Mbps.
Clocking: RS-232/V.35 DCE or DTE receiving timing from X.21 DCE device
Controls: Switchable, custom control settings

Power Supply: Rack-mount power supply is switchable between 120 VAC and 240 VAC; chassis supplies 10 VAC to the Model 2066RC, typical consumption is 1.2 watts
DCE to DCE buffering: Dual 16-bit buffers for full duplex operation—set to 8 bits in case of under- or overflow.
Temperature: 0–50°C / 32–122°F
Humidity: 0–95%, non-condensing
Dimensions: 0.95W x 3.1H x 5.4D in. (2.4W x 7.9H x 13.7D cm)



ORDERING INFORMATION

2066RC-226: V.35 to X.21 Converter Card

2066-26M/34X*: Cable, UD-26 Male to M/34

X=Specify Male or Female gender.

*Requires a UD-26 adapter cable.



See page 226

Passive RS-232 to V.35 Converters

Models 2020 Series

Connect RS-232 to V.35 using any gender and connector variation imaginable.

The Model 2020 Series solves one of the most common problems in WAN connectivity—connecting sync RS-232 hardware to sync V.35 hardware. And the Model 2020 series offers many different models to choose from.

The Model 2020N is the perfect solution for converter applications that do not require a built-in cable. It has all the features of the Model 2020 series contained in an ultra-miniature package.

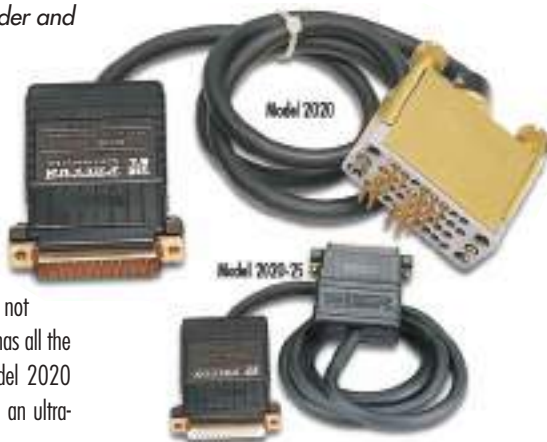

ORDERING INFORMATION

2020M-M: DB-25 male to M/34 male

2020F-M: DB-25 female to M/34 male

2020M-F: DB-25 male to M/34 fem.

2020F-F: DB-25 female (fem.) to M/34 female

2020NM-M: DB-25 male to M/34 male (integral connectors, no cable)

2020NF-M: DB-25 female to M/34 male (integral connectors, no cable)

2020NM-F: DB-25 male to M/34 female (integral connectors, no cable)

2020NF-F: DB-25 female to M/34 female (integral connectors, no cable)

Note: Standard 2020 models have DB-25 on the serial side and M/34 on the V.35 side on a 6-inch cable. 2020N models have integrated DB-25 and M/34 connectors. Other models available, call for details.

FEATURES & BENEFITS

- ✓ Bi-directional RS-232 to V.35 conversion
- ✓ Support for data rates to 384 kbps
- ✓ DCE/DTE switchable
- ✓ All appropriate data, clocking & control signals passed
- ✓ Equipped with built-in 6 ft (1.8 m) cable
- ✓ Model 2020N features integral connectors

SPECIFICATIONS

Format: Synchronous, transparent to protocol, full or half duplex; passes all appropriate control signals

Data Rates: Up to 384 kbps

Clocking: Supplied by the connected devices

Connectors: DB-25 male or female on RS-232 side, M/34 or DB-25 male or female on V.35 side

Configuration: DTE-to-DCE or DCE-to-DTE, strap selectable

Regulatory Approvals: FCC 15A, UL, CE, EN60950

The following models use a DB-25 version of the V.35 interface

2020M-25M: DB-25 male to DB-25 male

2020F-25M: DB-25 fem. to DB-25 male

2020M-25F: DB-25 male to DB-25 fem.

2020F-25F: DB-25 fem. to DB-25 fem.

RS-232 to V.35 Converter Rack Card

Model 2020RC

Our rack card converter comes with extra features!



The Model 2020RC fits in Patton's 16-slot rack chassis and our unique line of 2-, 4-, and 8-slot ClusterBoxes™.

The Model 2020RC rack card includes such features as LED indicators and DTE/DCE switchability for both the RS-232 and V.35 interfaces.



See page 226



FEATURES & BENEFITS

- ✓ LED indicators for TD, RD, RTS, CTS, CD, DTR and Power
- ✓ Both interfaces DTE/DCE switchable

SPECIFICATIONS

Format: Synchronous, transparent to protocol, full or half duplex; passes all appropriate control signals

Data Rates: Up to 384 kbps

Clocking: Supplied by the connected devices

Connectors: UD-26F connectors on both sides

Configuration: DTE-to-DCE or DCE-to-DTE, strap selectable

Regulatory Approvals: FCC 15A, UL, CE, EN60950

ORDERING INFORMATION

2020RC226: RS-232 to V.35 Rack Card (UD-26 female to UD-26 female)

Note: Requires UD-26 cable assemblies, call for details.



RS-232 to X.21 Interface Converter

Model 2021

Bridge the gap between LAN and WAN hardware

The Patton Model 2021 allows a synchronous RS-232 host to communicate bi-directionally with a synchronous X.21 device. Supporting synchronous data rates to 384 kbps, the Model 2021 is the smallest converter of its kind, and requires no AC power or batteries to operate. And there's no configuration needed for the Model 2021.



Because of its high speed capabilities, the Model 2021 is typically used in WAN connectivity, video conferencing and other high speed applications.

Since it's protocol independent and passes all appropriate data, clocking and control signals, the Model 2021 is as easy to use as a patch cable. Every system integrator's toolbox should contain a Model 2021!

FEATURES & BENEFITS

- ✓ Bi-Directional RS-232 to X.21 Conversion
- ✓ No AC Power or Batteries Required
- ✓ Supports Data Rates to 384 kbps
- ✓ Equipped with Integral 6 Foot Cable
- ✓ Passes Appropriate Control Signals

ORDERING INFORMATION

Factory Part Number Encoding

* M=male, F=female, T=DTE, C=DCE

2021 X X X
 X.21 DCE/DTE configuration¹
 X.21 (DB-15) gender*
 RS-232 DCE/DTE configuration¹
 RS-232 (DB-25) gender*

Typical application



SPECIFICATIONS

Data Rate: Up to 384 kbps
Operation: Synchronous transparent to protocol
Interfaces: RS-232 and X.21
Modes: Full or half duplex

Cable: 6 feet (1.8km)
Power: None required
Dimensions: 2.66 x 2.10 x 0.73 in.
 (6.8 x 5.3 x 1.9 cm)

Examples

2021MT-MC: (DB-25 male, DTE) to (DB-15 male, DCE)

Note: Many other models are available, check online at www.patton.com or call for details.

RS-232 to V.36 (RS-530/449) Interface Converter

Model 2022

This sync or async RS-232-to-V.36 (RS-530/449) converter bridges the gap between LAN and WAN hardware

The Model 2022 RS-232 to V.36 converter is the "missing link" between local area computing hardware and wide area communications hardware. Supporting synchronous data rates to 200 kbps, the Model 2022 is the smallest converter of its kind, and requires no AC power or batteries to operate.

With its DCE/DTE switching capability, the Model 2022 lets a V.36 host talk to a synchronous RS-232 modem; or lets a synchronous RS-232 terminal talk to a V.36 CSU/DSU. Once you've set the DCE/DTE strap, there's no other configuration needed. The 2022 is protocol independent, passing all appropriate data, clocking, and control signals, which makes it as easy to use as a patch cable. Every system integrator's toolbox should contain a Model 2022.



FEATURES & BENEFITS

- ✓ Bi-directional RS-232 to V.36 conversion
- ✓ No AC power or batteries required
- ✓ Supports data rates to 200 kbps
- ✓ Passes appropriate control signals
- ✓ DCE/DTE switchable

SPECIFICATIONS

Data Rate: Up to 200 kbps
Operation: Synchronous transparent to protocol
Interfaces: RS-232 and CCITT V.36/RS-449
Transmit Mode: Full or half duplex

Cable: 6 feet (1.8 m)
Power: None required
Dimensions: 2.66 x 2.10 x 0.73 in.
 (6.8 x 5.3 x 1.9 cm)

ORDERING INFORMATION

2022M-M: Male RS-232 to male DB-37

2022F-M: Female RS-232 to male DB-37

2022M-F: Male RS-232 to female DB-37

2022F-F: Female RS-232 to female DB-37

2022M-25M: Male RS-232 to male DB-25

2022F-25M: Female RS-232 to male DB-25

2022M-25F: Male RS-232 to female DB-25

2022F-25F: Female RS-232 to female DB-25

visit us online
www.patton.com

FAST Delivery From Your AUTHORIZED DISTRIBUTOR!



See
Pg 226**Micro V.35 to T1 Converter****Model 2090**

Convert a T1 port to V.35 or vice versa.



The Model 2090 changes a T1 port of a multiplexer, RAS, concentrator, or other device into a standard V.35 WAN port. The 2090 is configured by internal DIP switches and can be used in either clear channel mode (supporting a single 1.544 Mbps connection) or in Fractional mode (supporting speeds from 64 kbps to 1.536 Mbps in 64 kbps increments).

SPECIFICATIONS

WAN Speed: 1.544 Mbps
WAN Connection: RJ-48C
Nominal impedance: 100 ohm
DTE interface: Integral V.35, M/34 male
Line coding: AMI/B8ZS
Line framing: D4/ESF
Transmit LBO: Selectable—0, 7.5, 15, or 22.5 dB

Clock options: Internal, external and network clock
Standards: AT&T TR62411, ANSI T1.403, TR54016

Diagnostics: Responds to CO initiated D4 loopup and loopdown codes, ESF line loop and payload loop FDL messages, Universal Loopback de-activate message
Power supply: 120–240 VAC Universal input

FEATURES & BENEFITS

- ✓ Supports 1.544 Mbps (Clear Channel)
- ✓ Supports framed nx56/64 rates up to 1.536 Mbps in 64-kbps increments
- ✓ Seven easy-to-read LEDs

ORDERING INFORMATION

2090/CM/UI: V.35 (M/34 male) to G.703/G.704 (RJ-45), universal input power supply

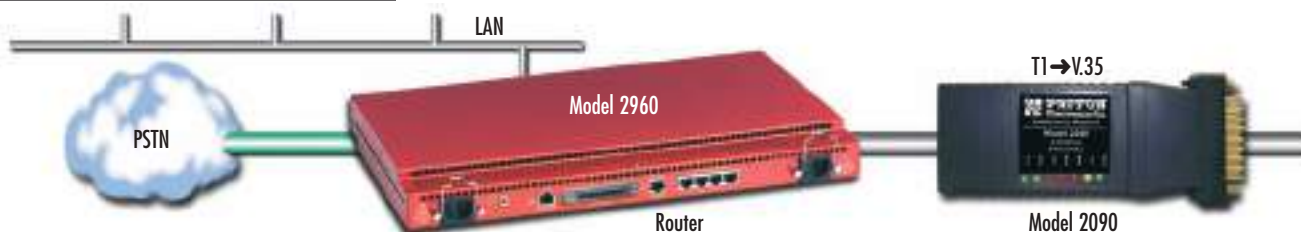
Typical application**Micro V.35 to G.703/G.704 (E1) Converter****Model 2094**

Micro E1 converter supports nx64 rates.

The Model 2094 enables a multiplexer or other device presenting an E1 or Fractional E1 G.703/G.704 interface to be converted to a V.35 interface, thereby letting V.35 devices connect to a G.703/G.704 network. The Model 2090 has internal DIP switches for configuration, and can be used in either clear channel mode (supporting a single

2.048 Mbps connection) or in G.704 mode (supporting speeds from 64 kbps to 2.048 Mbps in 64 kbps increments).

See
Pg 226**FEATURES & BENEFITS**

- ✓ Supports 1.544 Mbps (Clear Channel)
- ✓ Supports framed nx56/64 rates up to 1.536 Mbps in 64-kbps increments

SPECIFICATIONS

Network data rate: 2.048 Mbps
Network connector: RJ-48C
Nominal impedance: 120 ohm (75 ohm available when using Patton Model 460 balun)
DTE interface: V.35 (DCE orientation) on male M/34
Line coding: Selectable AMI or HDB3
Line framing: G.703 (unframed) or G.704/G.732 (framed) with selectable CAS and CRC-4 multiframeing

Clocking: Internal, external, or receive recover
DTE data rates: selectable nx64 kbps up to 2048 kbps
DS0 start position: Arbitrary
Diagnostics: V.54 loopback; V.52 patterns: 511, 2047, and QRSS
Configuration: 8-position DIP switch and RS-232 control port
Power supply: 100–240 VAC, 50–60 Hz, 0.4 A

ORDERING INFORMATION

2094/CM/UI: V.35 (M/34 male) to G.703/G.704 (RJ-45), universal input power supply). 48 VDC power supply also available.

Typical application

V.35 to HSSI Converter

Model 2040

HSSI converter lets V.35 serial devices access the WAN.

This V.35-to-high-speed-serial-interface (HSSI) converter lets a HSSI (HD-50) device communicate bi-directionally with a V.35 (M/34) device at sync. data rates up to 10 Mbps. The Model 2040 supports all HSSI co-directional timing patterns, two loopback modes (local line and remote line), plus data and control signals.

SPECIFICATIONS

HSSI Standards: ANSI/TIA/EIA-613, & ANSI/TIA/EIA-613
Data Rate: 0–10 Mbps

Clocking: All clocking modes supported except conversion from smooth to gapped clock

Loopbacks: Local line and remote line supported

Power supply: External 100–240 VAC transformer



FEATURES & BENEFITS

- ✓ Bi-directional conversion from V.35 to HSSI (high speed serial interface)
- ✓ Support for sync. rates up to 10 Mbps

ORDERING INFORMATION

2040MT-MC/UI: V.35 DTE (M/34 male) to HSSI DCE (HD-50 male)
2040MC-MT/UI: V.35 DCE (M/34 male) to HSSI DTE (HD-50 male)

Note: Many other models are available, check online at www.patton.com or call for details.

X.21 to HSSI Converter

Model 2041

HSSI converter lets X.21 serial devices access the WAN.

The Model 2041 X.21-to-high-speed-serial-interface (HSSI) converter lets a HSSI (HD-50) device communicate bi-directionally with an X.21 (DB-15) device at sync data rates up to 10 Mbps. The Model 2041 supports all HSSI co-directional timing patterns, two loopback modes (local line and remote line), plus data and control signals.

SPECIFICATIONS

HSSI Standards: ANSI/TIA/EIA-613, & ANSI/TIA/EIA-613
Data Rate: 0–10 Mbps

Clocking: All clocking modes supported except conversion from smooth to gapped clock

Loopbacks: Local line and remote line supported

Power supply: External 100–240 VAC transformer



FEATURES & BENEFITS

- ✓ Bi-directional conversion from X.21 to HSSI (high speed serial interface)
- ✓ Support for sync. rates up to 10 Mbps

ORDERING INFORMATION

2041FT-MC/UI: X.21 DTE (DB15 female) to HSSI DCE (HD-50 male)
2041FC-MT/UI: X.21 DCE (DB15 female) to HSSI DTE (HD-50 male)

Note: Many other models are available, check online at www.patton.com or call for details.

RS-422/530 to HSSI Converter

Model 2042

HSSI converter lets RS-422/530 serial devices access the WAN.

The Model 2042 RS-422/530-to-high-speed-serial-interface (HSSI) converter lets a HSSI (HD-50) device communicate bi-directionally with an RS-422/530 (DB-25) device at sync data rates up to 10 Mbps. The Model 2042 supports all HSSI co-directional timing patterns, two loopback modes (local line and remote line), plus data and control signals.

SPECIFICATIONS

HSSI Standards: ANSI/TIA/EIA-613, & ANSI/TIA/EIA-613
Data Rate: 0–10 Mbps
Clocking: All clocking modes supported except conversion from smooth to gapped clock

Loopbacks: Local line and remote line supported
Power supply: External 100–240 VAC transformer



FEATURES & BENEFITS

- ✓ Bi-directional conversion from RS-422/530 to HSSI (high speed serial interface)
- ✓ Support for sync. rates up to 10 Mbps

ORDERING INFORMATION

2042MT-MC/UI: RS-422/530 DTE (DB-25 male) to HSSI DCE (HD-50 male)
2042MC-MT/UI: RS-422/530 DCE (DB-25 male) to HSSI DTE (HD-50 male)

Note: Many other models are available, check online at www.patton.com or call for details.

Interface Powered, RS-232 to RS-485 Interface Converters (with Handshaking)

Models 2084, 2085, 2086, & 2089

Connect a DB-25 or DB-9 equipped PC or workstation to RS-485 data acquisition & control equipment.

The Model 208X Series of RS-232 to RS-485 converters include the Model 2085 DB-25 4-wire converter, Model 2089 DB-9 4-wire converter, Model 2084 DB-25 2-wire converter, Model 2086 DB-25 converter with built-in opto-isolation, and the Model 2085RC rack card.

The Model 2085 high speed RS-232 to RS-485 interface converter supports async RS-232 data rates to 115.2 kbps over one or two unconditioned twisted pair. Passing one control signal in each direction, the Model 2085 can handle up to 50 terminal drops in a multipoint polling environment. The Model 2085 has five configuration parameters, allowing the unit to be "fine tuned" to a variety of point-to-point or multipoint applications. In addition, silicon avalanche diodes provide 600 watts per wire of protection against harmful data line transient surges.

The Model 2089 is Patton's first high speed EIA-574 (RS-232 on a DB-9) to RS-485 interface converter.

Offering the same features as the Model 2085, except in a smaller DB-9 package, it supports async data rates to 115.2 kbps over one or two unconditioned twisted pair. The Model 2089 also handles up to 50 terminal drops in a multipoint polling environment; yet it is small enough to plug directly into a DB-9 serial port...and requires no AC power or batteries for operation. We've even managed to squeeze silicon avalanche diode surge protection into its tiny case. *Amazing!*

The Model 2084 provides 2-wire conversion of RS-232 to RS-485. Otherwise, the unit has the same features as the Model 2085.

The Model 2086 DB-25 RS-232-to-RS-485 converter provides opto-isolation.

The Model 2085RC is a dual port rack card version of the Model 2085, with two converters in one card! The front card incorporates 13 status LEDs, while the rear card presents four RJ-11 or RJ-45 connectors for hardware connection. The Model 2085RC fits in Patton's 16-slot rack chassis and our unique line of 2-, 4-, and 8-slot ClusterBoxes™.

Versions available for 2-wire RS-485 operation OR built-in opto-isolation.

Two converters in one rack card!

FEATURES & BENEFITS

- ✓ Fully conforms to the EIA-232 and EIA RS-485 standards
- ✓ Operates asynchronously, point-to-point or multipoint, over 2 or 4 wires (Model 2084 is 2-wire only)
- ✓ Data rates to 115,200 bps
- ✓ Range up to 9 mi. (14.5 km) when used in pairs
- ✓ Selectable RTS-CTS delay
- ✓ Selectable high/low impedance
- ✓ Operates with or without "echo"
- ✓ Up to 50 terminal drops in a multi-point polling environment
- ✓ No AC power or batteries required
- ✓ 600 watts of silicon avalanche diode surge protection
- ✓ Model 2086 features opto-isolation

SPECIFICATIONS

Transmission Format:

Asynchronous

Data Rate: Up to 115,200 bps

RS-232 Interface: DB-25, male or female (DCE/DTE switchable)

DB-9, male or female (Model 2089)

RS-485 Interface Options: DB-25, male or female; RJ-11 or RJ-45 jack; terminal block with strain relief

RTS/CTS Delay: 0 or 8 msec

Carrier: The carrier is switch selected either continuous operation or controlled by RTS

Control Signals: DSR turns "ON" immediately after the terminal raises DTR; DCD turns "ON" after recognizing the receive signal from the line; CTS turns "ON" after the terminal raises RTS.

Power: Draws operating power from RS-232 data and control signals; no AC power or batteries required.

Temperature: 32–122°F (0–50°C)
Size: 2.66 x 2.10 x 0.73 in. (6.8 x 5.3 x 1.9 cm)

Rack Mountable Units, Too!

These rack cards each contain two converters, so you can fit up to 32 converters in a 19 in. rack.



See page 226

Line Rate (bps)	Transmission Distances											
	19 AWG (0.9mm)			22 AWG (0.6mm)			24 AWG (0.5mm)			26 AWG (0.4mm)		
	feet	miles	km	feet	miles	km	feet	miles	km	feet	miles	km
1200	47520	9.0	14.5	34320	6.5	10.5	26400	5.0	8.0	21120	4.0	6.4
9600	36960	7.0	11.2	24288	4.6	7.4	18480	3.5	5.6	14784	2.8	4.5
38.4 k	26400	5.0	8.0	15312	2.9	4.7	11616	2.2	3.5	7920	1.5	2.4
115.2 k	18480	3.5	5.6	13728	2.6	4.2	7392	1.4	2.3	4752	0.9	1.5

Distances for the Models 2085 and 2089 when used in pairs.

RS-232 to RS-485 conversion

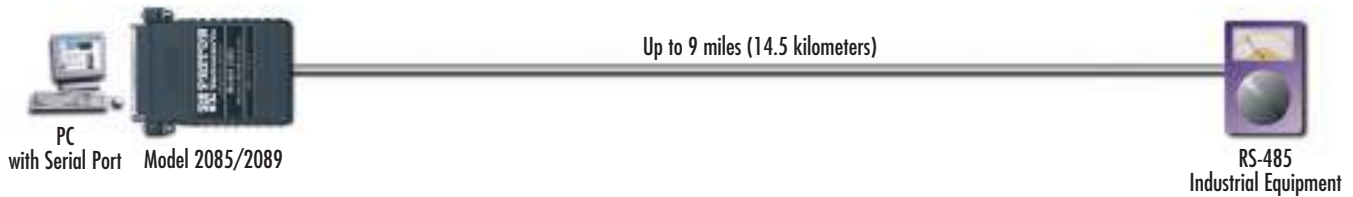

Connecting RS-232 and RS-485 devices in a multi-drop environment



ORDERING INFORMATION

Model 2085—4-wire DB-25 versions

- 2085M: Male DB-25 with terminal block
- 2085F: Female DB-25 with terminal block
- 2085X-RJ11: With RJ-11 jack
- 2085X-RJ45: With RJ-45 jack
- 2085X-DR11: With Dual RJ-11 jacks
- 2085X-DR45: With Dual RJ-45 jacks
- 2085X-25F: With DB-25 female
- 2085X-25M: With DB-25 male

Example

2085M-RJ11: Male DB-25, RJ-11 jack

Model 2089—DB-9 versions

- 2089M: Male DB-9 with terminal block
- 2089F: Female DB-9 with terminal block

Note: X = Male or female

- 2089X-RJ11: With RJ-11 jack
- 2089X-RJ45: With RJ-45 jack
- 2089X-DR11: With Dual RJ-11 jacks
- 2089X-DR45: With Dual RJ-45 jacks
- 2089X-25F: With DB-25 female
- 2089X-25M: With DB-25 male

Rack card versions (two converters per card)

- 2085RC11: Dual Rack Card, RJ-11
- 2085RC45: Dual Rack Card, RJ-45

Model 2084—2-wire DB-25 versions

- 2084M: Male DB-25 with terminal block
- 2084F: Female DB-25 with terminal block
- 2084X-RJ11: With RJ-11 jack
- 2084X-RJ45: With RJ-45 jack

- 2084X-DR11: With Dual RJ-11 jacks
- 2084X-DR45: With Dual RJ-45 jacks
- 2084X-25F: With DB-25 female
- 2084X-25M: With DB-25 male

Model 2086—Opto-Isolated DB-25 versions

- 2086M: Male DB-25 with terminal block and power supply
- 2086F: Female DB-25 with terminal block and power supply
- 2086X-RJ11: With RJ-11 jack
- 2086X-RJ45: With RJ-45 jack
- 2086X-DR11: With Dual RJ-11 jacks
- 2086X-DR45: With Dual RJ-45 jacks
- 2086X-25F: With DB-25 female
- 2086X-25M: With DB-25 male

visit us online
www.patton.com

FAST Delivery From Your AUTHORIZED DISTRIBUTOR!



Interface-Powered, RS-232 to RS-422 Converters (Transmit & Receive Data Only)

Models 222N, 222N9, & 222NRC

These miniature converters are no bigger than a DB-25 (or DB-9) backshell!

The Model 222N Series of converters comes in three versions: the Model 222N, 222N9, and 222NRC.



The **Model 222N** enables an RS-232 device with DB-25 port to connect to an RS-422 device—at distances up to 4,000 ft (1,219 m) away—over two twisted-pair wires. The **Model 222N9** does the same thing for an RS-232 device with a DB-9 port (now called EIA-574).

The **Model 222NRC** is a dual port rack card version of the Model 222N, with two converters in one card! The front card incorporates 13 status LEDs, while the rear card presents four RJ-11 or RJ-45 connectors for hardware connection. The Model 222NRC fits in Patton's 16-slot rack chassis and our unique line of 2-, 4, and 8-slot ClusterBoxes™.



ORDERING INFORMATION

Examples of DB-25 and DB-9 versions



See Pg 226

DB-25 versions

222NM: Male DB-25 with terminal block (TB)

222NF: Female DB-25 with TB

222NF RJ11: With RJ-11 jack

222NM RJ45: With RJ-45 jack

222NM-25F: With DB-25 male to female

222NF-25F: With DB-25 female to female

222NSF: With surge protection

DB-9 versions

222N9M: Male DB-9 with TB

222N9F: Female DB-9 with TB

222N9F RJ11: With RJ-11 jack

222N9M RJ45: With RJ-45 jack

222N9SF: With surge protection

Rack card versions (two converters per card)

222NRC11: Dual Rack Card, RJ-11

222NRC45: Dual Rack Card, RJ-45

Note: Many other models are available, check online at www.patton.com or call for details.

FEATURES & BENEFITS

- ✓ Converts EIA-232 data to EIA-422
- ✓ Async. transmit & receive data signals only
- ✓ EIA-232 control signals wired together
- ✓ Operates at rates up to 19,200 bps
- ✓ No AC power or batteries required
- ✓ DCE/DTE selectable interfaces
- ✓ Virtually any connectorization available

RS-232 to 422 converter

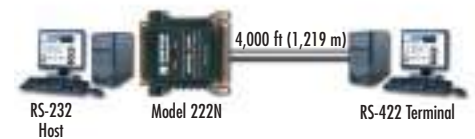

SPECIFICATIONS

Data Format: Asynchronous

Data Rate: 0 to 19,200 bps (no strapping)

Control Signals: (RS-232 Side) RTS wired to CTS; DTR wired to DSR and DCD

Transmit Mode: Full duplex, 4-wire

DTE/DCE Switch: On standalone Model 222N version only

CE Approved: Yes

Power Supply: None required; uses ultra low power from EIA data and control signals

Connectors: Model 222N—Male or female DB-25 (232 side); Male or Female DB-25, RJ-11 jack, RJ-45 jack or terminal posts (422 side).

Model 222N9—Male or female DB-9 (EIA-574 side); RJ-11 jack, RJ-45 jack or terminal posts (422 side).

Dimensions:

Model 222N
2.20 x 1.75 x 0.75 in.
(5.6 x 4.4 x 1.9 cm)
Model 222N9
2.50 x 1.20 x 0.75 in.
(6.4 x 3 x 1.9 cm)

Self-Powered RS-232 to TTL

Model 2002

Now async RS-232 devices can communicate bi-directionally with TTL devices

The Model 2002 RS-232 to TTL interface converter lets an async RS-232 device communicate bi-directionally with an asynchronous TTL device. Supporting data rates up to 230 kbps, the Model 2002 passes data (TD, RD) plus five control signals (CD, DTR, DSR, CTS and RTS). In addition, the

Model 2002 allows data and control signals to be independently jumper-selected as *inverting* or *non-inverting*. The Model 2002 is available DCE-to-DTE and DTE-to-DCE.



Typical application

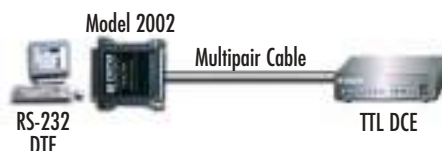

SPECIFICATIONS

Humidity: Up to 95% non-condensing
Power Supply: None required; uses power from RS-232 and TTL data and control signal

Dimensions: 2.24L x 2.1H x 0.7W in. (5.6L x 5.3H x 1.8W cm)
Weight: 1.7 oz. (48.2g)

FEATURES & BENEFITS

- ✓ Supports data rates to 230 kbps
- ✓ Passes TD & RD plus five control signals: CD, DTR, DSR, CTS & RTS
- ✓ Data and control signals independently selectable for inverting/non-inverting
- ✓ RS-232 interface is a DB-25 female, TTL interface is a DB-25 male

ORDERING INFORMATION

2002FC-MT: RS-232 (DB-25 female/DCE) to TTL (DB-25 male/DTE)

2002FT-MC: RS-232 (DB-25 female/DTE) to TTL (DB-25 male/DCE)

Note: Other models are available, check online at www.patton.com or call for details.

PATTON

Network Access & Connectivity Solutions for Enterprise, Carrier & Industrial Applications

Patton Electronics—a leader in the production of network access and connectivity products—is building on its expertise in integrated network access, transmission, IP and Frame Relay technologies and leading in the development of right-priced products to simplify human and machine access to the global network.

The Patton brothers, Bobby and Burt, founded Patton Electronics in 1984, while students in college. Over the succeeding 20+ years, Patton has taken those simple beginnings and expanded into a multi-national manufacturing company that today employs more than 180 people and provides a product line in excess of 1000 items.

For your next project that needs to meet aggressive price points, while delivering high performance results, call on Patton. We're ready to deliver!



www.patton.com

RS-232 to Current Loop Converters (20mA or 60mA)**Model 2017 Series**

Whether your current loop device is active or passive, we've got your converter!

The Patton Model 2017 Series of current loop converters lets an async. RS-232 device communicate with a 20mA or 60mA current loop device. The interface-powered Model 2017P (20mA) and 2017P60 (60mA) operate passively, and therefore are suitable for connection to active current loop devices. The AC-powered Model 2017A works with either active or passive 20mA current loop devices. All models support distances to 4 miles (6.4 km) and data rates to 115.2 kbps. In addition, all models are optically isolated, surge protected and DCE/DTE switchable. The Model 2017A also provides three LED indicators. Twisted pair running to the current loop device

attaches by RJ-11 jack, RJ-45 jack or terminal blocks.

The Model 2017RC is an async device that operates bi-directionally in full- or half-duplex modes. The Model 2017RC occupies

one slot of the 1000R/16 front-load rack. It has dual independent converters that enable two async DTE RS-232 devices to communicate with two 20-mA current loop devices over two twisted pairs. It can be configured for active or passive transmitters.

**SPECIFICATIONS**

Transmission Line: 19 to 26 AWG (.9 to .4mm) twisted pair
Range: 4 miles on 24 AWG (.5mm) wire
Interfaces: Async., EIA RS-232, CCITT V24 full duplex, 20mA or 60mA current loop
LEDs: (Model 2017A only)—TD (Transmit Data) and RD (Receive Data)

Connectors: DB-25 male or female on RS-232 side RJ-11, RJ-45 or terminal posts with strain relief for current loop side
Data Rates: up to 115,200 bps
Isolation: 2500V RMS via opto-isolators

Surge Suppression: Over-voltage protection for opto-isolators via silicon avalanche diodes
Op. Temp.: 32–122°F (0–50°C)
Altitude: 0–15,000 feet
Humidity: Up to 95% non-condensing
Power Supply: Model 2017A—9V to 12V on pin 9 of RS-232 interface or

external wall mount transformer; Model 2017P and 2017P60—None required; uses power from interface data signals
Dimensions: 2.50L x 1.2H x 0.75W in. (6.4L x 3H x 1.9W cm)
Weight: 1.5 oz. (43 grams)

RS-232 to 20mA Current Loop Converter (DB-25 to DB-25)**Model 2018**

This optically isolated converter performs multiple functions

The Model 2018 is a multi-function converter. Connect it to an active 20mA current loop circuit and it becomes a passive converter. Attach it to a passive 20mA current loop circuit, add DC power to one of several DB-25 interface pins, and it functions as an active converter. Connect two units together, supply DC power to one interface, and you have an optically isolated RS-232 distance extender.

The Model 2018 supports data rates to 19.2 kbps, and current loop distances to 4 mi. (6.4 km) over two twisted pair. It

connects directly to the RS-232 interface or the 20mA current loop interface using a male or female DB-25 connector. An external DCE/DTE switch eliminates the need for RS-232 crossover cables.

**SPECIFICATIONS**

Interfaces: Asynchronous
Transmit Line: 19–26 AWG (.9–.4mm)
Range: 4 mi. (6.4 km) on 24 AWG twisted pair

Interfaces: EIA RS-232, CCITT V24 (.5 mm) full duplex, 20mA current loop
Data Rate: 50–19.2 kbps
Isolation: 2500V RMS via opto-isolators on line side

Connectors: Male or female DB-25 on both sides
Op. Temp.: 0–50°C (32–122°F)
Humidity: Up to 95% non-condensing
Power Supply: None required; uses power from NIC data signals

Dimensions: 2.21L x 0.8H x 2.10W in. (5.6L x 2.0H x 5.3W cm)
Weight: 1.7 oz. (48.2g)

FEATURES & BENEFITS

- ✓ Data rates to 115.2 kbps
- ✓ Up to 4 mi. (6.4 km) on two 24 AWG (.5mm) twisted pair
- ✓ Model 2017P & 2017P60 work with active 20mA or 60mA receivers
- ✓ Model 2017A works with active or passive 20mA receivers
- ✓ Externally accessible DCE/DTE switch
- ✓ Optically isolated and silicon avalanche diode surge protected

ORDERING INFORMATION

2017PM: RS-232 to 20mA (passive) DB-25M with terminal block

2017PF: RS-232 to 20mA (passive) (DB-25F with terminal block)

2017P60M: RS-232 to 60mA (passive) (DB-25M with terminal block)

2017P60F: RS-232 to 60mA (passive) (DB-25F with terminal block)

2017AM: RS-232 to 20mA (active) (DB-25M with terminal block)

2017AF: RS-232 to 20mA (active) (DB-25F with terminal block)

2017XXRJ11: With RJ-11 jack

2017XXRJ45: With RJ-45 jack

Example

2017PM RJ11: Male DB-25, RJ-11 jack

Rack card versions

2017RC11: Dual 20mA rack card, RJ-11

2017RC45: Dual 20mA rack card, RJ-45

Note: Other models are available, call for details.

FEATURES & BENEFITS

- ✓ Data rates from 50 bps to 19.2 kbps
- ✓ Range to 4 mi. (6.4 km) on two 24 AWG (.5mm) twisted pair
- ✓ No AC power required; draws necessary power for (passive) operation from RS-232 interface
- ✓ Optically isolated on line side
- ✓ DB-25 connectors on both ends
- ✓ Two units can work together as optically isolated RS-232 distance extenders

ORDERING INFORMATION

2018M-F: Male RS-232 to female 20mA

2018F-M: Female RS-232 to male 20mA

Note: Other models are available, check online at www.patton.com or call for details.

Ethernet to RS-232 Converter/Terminal Server

Model 2120

The versatile Patton Model 2120 connects serial RS-232 devices to a local area network and also functions as a single-port terminal server.

Patton's Model 2120 Single Port Terminal Server provides a quick, simple, and cost effective solution for connecting traditional RS-232 terminals and devices to a local area network.

The Model 2120 brings serial RS-232 devices onto the network by encapsulating RS-232 data into IP packets for transport over the LAN. Using Raw TCP or TELNET, the Model 2120 can connect to any user-defined IP address and port. Once connected to the remote host, data is passed transparently end-to-end. The built-in DHCP Client allows the Model 2120 to dynam-

ically obtain an IP address and a subnet mask from a master server. Using dial-up modems and SLIP and PPP connections, remote users can access the network as if they were locally connected.



SPECIFICATIONS

Serial Interface: DB-25 male or female; DB-9 male or female
Serial Transmission: RS-232 Asynchronous, 0 to 115.2 kbps, configured via TELNET or serial port
DCE/DTE: Configured via TELNET or serial port
RS-232 Status Indicators: TXD, RXD, DTR, RTS, CTS, DCD, and Power

Ethernet Interface: Shielded RJ-45 female
Ethernet Standard: 10Base-T (IEEE 802.3)
Ethernet Status Indicators: Ethernet link and status
Protocols Supported: TCP, UDP, IP, ICMP, TELNET, RLOGIN, ARP, DHCP, FTP, TFTP, SLIP, PPP, PAP, DNS, and WINS

Management Services: Monitoring, control, and diagnostics via serial port or TELNET session
Memory: 1 Mbyte RAM; 512 kbytes FLASH
Power Supply Options: External, universal AC (100–240 VAC) or -48 VDC
Temperature: 32–122°F (0–50°C)
Humidity: Up to 95% non-condensing

Dimensions: 3.5L X 2.1W X 0.78H in. (9.0L X 5.3W X 1.9H cm)
Weight: 0.2 lbs (0.09 kg)

FEATURES & BENEFITS

- ✓ Enables control of any RS-232 asynchronous serial device over a LAN or via the Internet
- ✓ Asynchronous data rates up to 115.2 kbps
- ✓ DTE/DCE-selectable serial port
- ✓ 802.3 10Base-T LAN connection via RJ-45 for network connection



ORDERING INFORMATION

- Single Port RS-232 Terminal Server, Asynchronous**
- 2120/AM/UI: DB-25 Male, UI Power Supply
 - 2120/AM/48: DB-25 Male, -48 VDC Power Supply
 - 2120/AF/UI: DB-25 Female, UI Power Supply
 - 2120/AF/48: DB-25 Female, -48 VDC Power Supply
 - 2120/A9M/UI: DB-9 Male, UI Power Supply
 - 2120/A9M/48: DB-9 Male, -48 VDC Power Supply
 - 2120/A9F/UI: DB-9 Female, UI Power Supply
 - 2120/A9F/48: DB-9 Female, -48 VDC Power Supply

Ethernet to V.35 Converter/Bridge

Models 2135 & 2135C

This device converts 10Base-T Ethernet (RJ-45) to WAN via a V.35 (M/34) connection

The Patton Model 2135 converter features a V.35 (M/34) serial interface to make your WAN connection easy. It is equipped with an 802.3 10Base-T Ethernet RJ-45 jack, which allows a direct connection to your network equipment.



SPECIFICATIONS

DTE Interface: V.35
Network Interface: IEEE 802.3 10Base-T (RJ-45)
Transmission: Synchronous up to 10 Mbps
Protocol: PPP (RFC 1661) with Bridging Control Protocol (RFC 1638)
Memory: 1MB RAM, 128KB FLASH memory

MAC Address Table Size: 4096 entries
MAC Address Aging: MAC addresses deleted after eight minutes of inactivity
LEDs LAN Side: (1) yellow, general status; (1) green, link integrity
LEDs DTE Side: TXD, RXD and Power, (green); DTR, DCD, CTS and CLK, (yellow)

Power Supply Input: 100–240VAC, 50–60Hz, 0.4A; or optional -48 VDC
Power Consumption: 500mA @ 5VDC
Temperature: 32–122°F (0–50°C)
Altitude: 0–15,000 ft (0–4,572 m)
Humidity: Up to 90%, non-condensing

Dimensions: 3.5 L X 2.1 W X 0.78 H inch (9.0 L X 5.3 W X 2.0 H cm)
Weight: 0.72 lbs (0.32 kg)
Compliance: FCC Part 15A; CE Mark per EEC Directive: 89/336/EEC; Low Voltage Directive: 73/23/EEC

FEATURES & BENEFITS

- ✓ Industry standard, shielded RJ-45 10Base-T connection
- ✓ 802.3 Ethernet supported by transparent LAN bridging
- ✓ V.35 WAN interface on an M/34 connector
- ✓ Automatic learning and aging with support for up to 4,096 MAC addresses
- ✓ Nine LEDs monitor power, LAN link, and DTE interface signals
- ✓ PPP bridging control protocol (RFC 1638) with auto detection for compatibility with existing Patton bridge products and standard third-party equipment

ORDERING INFORMATION

- 2135C/CM-X/UI: V.35 DTE with M/34 Male, Serial Cable, 100–240 VAC
 - 2135C/CM-X/48: V.35 DTE with M/34 Male, Serial Cable, -48VDC
 - 2135/CM/UI: Ethernet MicroBridge, V.35 DTE with M/34 Male, 100–240 VAC
 - 2135/CM/48: Ethernet MicroBridge, V.35 DTE with M/34 Male, -48VDC
- Note:** X= "L" 6-foot (182.88 cm) Serial Cable or "S" 6-inch (15.24 cm) Serial Cable. Example: 2135/CM-S/UI Ethernet MicroBridge, V.35 DTE with M/34 Male, 6-in. (15.24 cm) Serial Cable, UI

Ethernet to X.21 Converter/Bridge**Model 2121**

This device connects your X.21 serial devices to Ethernet networks

SPECIFICATIONS**DTE Interface:** X.21

Network Interface: IEEE 802.3 10Base-T (RJ-45)

Transmission: Sync up to 10 Mbps

Protocol: PPP (RFC 1661) with Bridging Control Protocol (RFC 1638)

Memory: 1MB RAM, 128KB FLASH

MAC Address Table Size:

4096 entries

MAC Address Aging: MAC addresses deleted after eight minutes of inactivity

LEDs LAN Side: (1) yellow, general status; (1) green, link integrity

LEDs DTE Side: TXD, RXD and Power, (green); DTR, DCD, CTS and CLK, (yellow)

Power Supply Input: 100–240VAC, 50–60Hz, 0.4A; or optional -48 VDC

Power: 500mA @ 5VDC

Temp: 32–122°F (0–50°C)

Humidity: Up to 90% R.H., non-condensing

Dimensions: 3.5 L X 2.1 W X 0.78 H inch (9.0 L X 5.3 W X 2.0 H cm)

Weight: 0.72 lbs (0.32 kg)

Compliance: FCC Part 15A; CE Mark per EEC Directive: 89/336/EEC; Low Voltage Directive: 73/23/EEC

**ORDERING INFORMATION**

2121/DM-X/UI: Ethernet MicroBridge, X.21 DTE with DB-15 Male, Serial Cable, 100–240 VAC

2121/DM-X/48: Ethernet MicroBridge, X.21 DTE with DB-15 Male, Serial Cable, -48VDC

Note: X= "L" 6-foot (182.88 cm) Serial Cable or "S" 6-inch (15.24 cm) Serial Cable. Example: 2121/DM-S/UI Ethernet MicroBridge, X.21 DTE with DB-15 Male, 6-in. (15.24 cm) Serial Cable, UI

Ethernet to V.24 Converter/Bridge**Model 2124**

This device connects your V.24 serial devices to Ethernet networks

SPECIFICATIONS**DTE Interface:** V.24

Network Interface: IEEE 802.3 10Base-T (RJ-45)

Transmission: Sync up to 10 Mbps

Protocol: PPP (RFC 1661) with Bridging Control Protocol (RFC 1638)

Memory: 1MB RAM, 128KB FLASH

MAC Address Table Size:

4096 entries

MAC Address Aging: MAC addresses deleted after eight minutes of inactivity

LEDs LAN Side: (1) yellow, general status; (1) green, link integrity

LEDs DTE Side: TXD, RXD and Power, (green); DTR, DCD, CTS and CLK, (yellow)

Power Supply Input: 100–240VAC, 50–60Hz, 0.4A; or optional -48 VDC

Power: 500mA @ 5VDC

Temp: 32–122°F (0–50°C)

Humidity: Up to 90% R.H., non-condensing

Dimensions: 3.5 L X 2.1 W X 0.78 H inch (9.0 L X 5.3 W X 2.0 H cm)

Weight: 0.72 lbs (0.32 kg)

Compliance: FCC Part 15A; CE Mark per EEC Directive: 89/336/EEC; Low Voltage Directive: 73/23/EEC

**ORDERING INFORMATION**

2124/AM-X/UI: Ethernet MicroBridge, V.24 DTE with DB-25 Male, Serial Cable, 100–240 VAC

2124/AM-X/48: Ethernet MicroBridge, V.24 DTE with DB-25 Male, Serial Cable, -48VDC

Note: X= "L" 6-foot (182.88 cm) Serial Cable or "S" 6-inch (15.24 cm) Serial Cable. Example: 2124/AM-S/UI Ethernet MicroBridge, V.24 DTE with DB-25 Male, 6-in. (15.24 cm) Serial Cable, UI



I'm Danny, one of Patton's Support Engineers. If you're having a problem with a Patton product, I'll find the solution quickly. To buy one of these micro bridges, call +1 301.975.1000 or send e-mail to sales@patton.com.

Ethernet to EIA-530 Converter/Bridge**Model 2130**

This device connects your EIA-530 serial devices to Ethernet networks

SPECIFICATIONS**DTE Interface:** V.24

Network Interface: IEEE 802.3 10Base-T (RJ-45)

Transmission: Sync up to 10 Mbps

Protocol: PPP (RFC 1661) with Bridging Control Protocol (RFC 1638)

Memory: 1MB RAM, 128KB FLASH

MAC Address Table Size:

4096 entries

MAC Address Aging: MAC addresses deleted after eight minutes of inactivity

LEDs LAN Side: (1) yellow, general status; (1) green, link integrity

LEDs DTE Side: TXD, RXD and Power, (green); DTR, DCD, CTS and CLK, (yellow)

Power Supply Input: 100–240VAC, 50–60Hz, 0.4A; or optional -48 VDC

Power: 500mA @ 5VDC

Temp: 32–122°F (0–50°C)

Humidity: Up to 90% R.H., non-condensing

Dimensions: 3.5 L X 2.1 W X 0.78 H inch (9.0 L X 5.3 W X 2.0 H cm)

Weight: 0.72 lbs (0.32 kg)

Compliance: FCC Part 15A; CE Mark per EEC Directive: 89/336/EEC; Low Voltage Directive: 73/23/EEC

**ORDERING INFORMATION**

2130/BM-X/UI: Ethernet MicroBridge, EIA-530 DTE with DB-25 Male, Serial Cable, 100–240 VAC

2130/BM-X/48: Ethernet MicroBridge, EIA-530 DTE with DB-25 Male, Serial Cable, -48VDC

Note: X= "L" 6-foot (182.88 cm) Serial Cable or "S" 6-inch (15.24 cm) Serial Cable. Example: 2130/BM-S/UI Ethernet MicroBridge, EIA-530 DTE with DB-25 Male, 6-in. (15.24 cm) Serial Cable, UI

Auto-Directional Serial to Parallel Converters

Models 2025, 2029, 2035, & 2039

These miniature converter cables automatically select parallel/serial mode

The Models 2025 & 2029 miniature converters represent a breakthrough in size and performance. They support auto-directional data conversion, serial data rates to 38.4 kbps, plus hardware and X-On/X-Off handshaking. Yet they are no larger than a DB-9 or DB-25 backshell (excluding cable), and require no AC power or batteries for operation.

The Model 2025 plugs directly into an RS-232 device with a DB-25 serial port. The Model 2029 plugs directly into an EIA-574 (RS-232) device with a DB-9 serial port. Both models use microprocessor technology to automatically orient themselves for serial-to-parallel or parallel-to-serial data conversion. A single LED indicator monitors five modes, including transmit status.



Model 2025

Model 2029

FEATURES & BENEFITS

- ✓ Data rates to 38.4 kbps (Models 2025 or 2029) or 115.2 kbps (Models 2035 or 2039)
- ✓ Integral 6 foot (1.8m) cable
- ✓ Auto-directional data conversion
- ✓ Automatic DCE/DTE mode selection
- ✓ Support for hardware *and* software X-On/X-Off flow control
- ✓ Data rates to 38,400 bps (Models 2025 and 2029)
- ✓ Data rates to 115.2 kbps (Models 2035 and 2039)
- ✓ Link Status LED indicator

SPECIFICATIONS

Data Rate: 0.3, 0.6, 1.2, 2.4, 4.8, 9.6, 19.2, 38.4 kbps selected by external DIP switch (for speeds up to 115.2 kbps (2035 and 2039))

Characters: 7 or 8 data bits, one stop bit
Parity: Even, odd, or no parity
Cable Length: 6.0 feet (1.8m)
Power: No AC power required

Data Format: Asynchronous serial/36-pin parallel

ORDERING INFORMATION

DB-25 versions

2025: Serial (DB-25 female) to parallel (36-pin male)

2025-25M: Serial (DB-25 female) to parallel (DB-25 male)

2025GCM: Serial (DB-25 male) to parallel (36-pin male)

2025GCM-25M: Serial (DB-25 male) to parallel (DB-25 male)

2035: Serial (DB-25 female) to parallel (36-pin male)

2035-25M: Serial (DB-25 female) to parallel (DB-25 male)

2035GCM-25M: Serial (DB-25 male) to parallel (DB-25 male)

DB-9 versions

2029: Serial (DB-9 female) to parallel (36-pin male)

2029-25M: Serial (DB-9 female) to parallel (DB-25 male)

2039: Serial (DB-9 female) to parallel (36-pin male)

2039-25M: Serial (DB-9 female) to parallel (DB-25 male)

Note: Other models are available, call for details.

Compact Interface Serial to Parallel Converters

Models 2026, 2027, 2036, & 2037

These converters automatically sense and select parallel/serial and DCE/DTE modes

These auto-directional parallel to serial converters automatically orient themselves for parallel/serial direction and DTE/DCE orientation. In addition, all units are self-powered, support hardware and X-ON/X-OFF flow control, and can be configured from external DIP switches.

The Model 2026 supports serial data rates up to 38.4 kbps, while the Model 2036 goes all the way up to 115.2 kbps!

The 2026 and 2036 have a DB-25 and a 36-pin connector. The Model 2027 supports serial data rates up to 38.4 kbps, while the 2037 supports rates up to 115.2 kbps. The 2027 and 2037 have DB-25 connectors at both ends.



Model 2026

Model 2027

FEATURES & BENEFITS

- ✓ Auto-directional data conversion
- ✓ Automatically selects parallel-to-serial or serial-to-parallel operation
- ✓ Automatically selects DCE/DTE mode
- ✓ Supports hardware *and* software X-On/X-Off flow control
- ✓ Data rates from 300 bps to 38.4 kbps (Models 2026 & 2027) or up to 115.2 kbps (Models 2036 & 2037)
- ✓ External configuration switches

SPECIFICATIONS

Data Rate (selected by external switches): 2026 & 2027—300, 600, 1200, 2400, 4800, 9600, 19,200, 38,400 bps; 2036 & 2037—up to 115.2 kbps

Power: No AC power required; uses ultra low power derived from the RS-232 data and control signals

Connectors: Model 2026 & 2036—DB-25 female, 36 pin male or female; Model 2027 & 2037—two DB-25 female connectors

Parity: Even, odd, or no parity with 7 or 8 data bits

ORDERING INFORMATION

2026-F: Converter, serial DB-25 female and parallel 36-pin male

2036-M: Converter, serial DB-25 male and parallel 36-pin male

2036-F: Converter, serial DB-25 female and parallel 36-pin male

2027F-F: Converter, serial DB-25 female and parallel DB-25 female

2027F-M: Converter, serial DB-25 female and parallel DB-25 male

2037F-F: Converter, serial DB-25 female and parallel DB-25 female

2037F-M: Converter, serial DB-25 female and parallel DB-25 male

visit us online

www.patton.com

FAST Delivery From Your AUTHORIZED DISTRIBUTOR!

PATTON
Electronics Co.

Powered Serial to Parallel Printer Converter

Model 2036P

AC power supply enables operation in low power applications

The Patton Model 2036P is a self-contained printer converter that supports both hardware and X-ON/X-OFF handshaking, as well as asynchronous serial data rates up to 115.2 kbps. The Model 2036P receives operating power from the RS-232 interface, or—in the case of low-power interfaces—from an external AC power supply (included). Able to automatically configure itself for parallel/serial direction and DTE/DCE orientation, the Patton 2036P is otherwise configured using convenient external DIP switches.



FEATURES & BENEFITS

- ✓ Async data rates to 115.2 kbps
- ✓ Automatically selects parallel-to-serial or serial-to-parallel operation
- ✓ Automatically selects DCE/DTE mode
- ✓ Supports hardware *and* X-On/X-Off flow control
- ✓ External configuration switches

ORDERING INFORMATION

2036P: Converter, Device End DB-25 female and 36-pin male, 120 VAC

2036P/230: Converter, Device End DB-25 female and 36-pin male, 230 VAC

Note: Other models are available, call for details.

Typical application



RS-232/423 to IEEE-1284 Converter

Model 2030

This converter complies with the IEEE-1284 standard for Level 1 hardware.

The Patton Model 2030 RS-232/423 Serial to IEEE-1284 Bi-Directional Parallel Converter lets you connect asynchronous RS-232/423 serial hardware to a printer or other device equipped with an IEEE-1284 bi-directional parallel interface. Able to work in either Level 1 Compatible or Nibble modes (according to the IEEE-1284 Standard), the Model 2030 supports the high speeds necessary for graphics-intensive laser printer applications.



The Model 2030 supports serial data rates to 115.2 kbps and works with all IEEE-1284 Level 1 compatible hardware, (including Level 2 hardware with Level 1 backward compatibility). Nibble operations are translated into standard Hewlett-Packard™ LaserJet® IV serial printer escape sequences for operation with standard printer drivers. Power may be supplied by both interfaces, or by a plug-in AC adapter.

FEATURES & BENEFITS

- ✓ Async data rates to 115.2 kbps
- ✓ Supports two IEEE-1284 modes: compatible and nibble (switchable)
- ✓ 10KV ESD protection on serial interface
- ✓ Works with Level 1 hardware
- ✓ Power derived from both interfaces, or from external AC power supply
- ✓ LEDs for power and data mode (distinctive blinking)
- ✓ Plugs directly into 36-pin interface
- ✓ Miniature size fits in tight spaces

Typical application



SPECIFICATIONS

Transmission Format: Asynchronous, full duplex on the serial side; IEEE-1284 on the parallel side, supporting Compatibility and Nibble Modes (switchable)

Connectors: 36-pin male, RJ-45 female
ESD Protection: 10KV
Data Rates: 9.6, 19.2, 38.4 and 115.2 kbps

Range: Meets capacitive and resistive load requirements of RS-232 and RS-423
Power Supply: Power derived from RS-232/423 and IEEE-1284 interfaces.
Note: IEEE 1284 B interface must support the optional 5V on pin 18, and IEEE 1284 C must support interface pin 36 (peripheral logic high). Otherwise, power must be supplied using the optional AC wall mount power supply.
Op. Temp.: 32–122°F (0–50°C)

ORDERING INFORMATION

2030: Async RS-232/423 to IEEE-1284 Converter (120V)

2030-220: Async RS-232/423 to IEEE-1284 Converter (220V)

Self-Powered Parallel Line Extenders

Model 1225

Extend parallel communication to 2000 ft (610 m) over a single twisted pair

The Patton Model 1225 ParaLink™ answers a common office complaint: “Why can’t we move our printer further away?” The interface-powered ParaLink converts parallel signals to serial and transmits them up to 2000 feet (610m) before converting them back to parallel. This overcomes the inherent distance limitations of parallel com-

munications! What’s more, the ParaLink transmits over a single pair of cable: No more bulky 25 or 36 conductor cables! Because the ParaLink lets you choose between BUSY and ACKNOWLEDGE handshaking modes, it is compatible with most parallel printers and sharing devices on the market.



SPECIFICATIONS

Parallel Interface: Centronics®/ IBM Parallel (DB-25)
Range: Up to 2000 feet (610m)
Transmit Line: One unconditioned twisted pair (2 wires)

Transmit Mode: Half duplex
Line Connection: RJ-11 or RJ-45 jack or 2 position terminal post and a strain relief

Interface Signals: Data bits 0-7, ground, busy or acknowledge (external switch selectable)

Power Supply: Interface powered, no AC power or batteries required

Dimensions: 2.67”L x 2.10”W x 0.74”H (6.7 x 5.3 x 1.88 cm)

Typical application

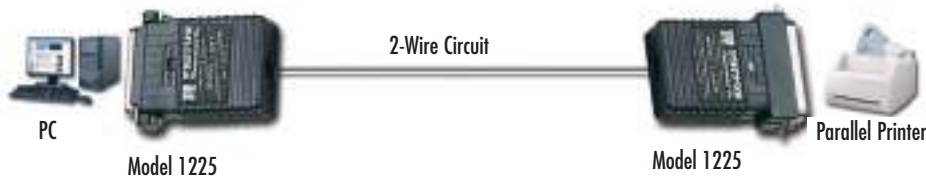

FEATURES & BENEFITS

- ✓ Extends parallel communication to 2000 feet (610 m) over a single twisted pair
- ✓ Interface powered—no AC needed
- ✓ Switchable ACK / BUSY handshaking enhances printer compatibility
- ✓ Accommodates low power printer interfaces
- ✓ DB-25 or Centronics connectors
- ✓ Compatible with most parallel printers and printer sharing devices
- ✓ RJ-11, RJ-45 or terminal block twisted pair connection

ORDERING INFORMATION

Note: The Model 1225 must be purchased in pairs (a transmitter and a receiver).

1225TM: Transmitter, male DB-25 with terminal block

1225CRM: Centronics receiver, male with terminal block

1225RM: Receiver, male DB-25 with terminal block

1225RF: Receiver, female DB-25 with terminal block

1225TMRJ11: Transmitter, male DB-25 with RJ-11

1225CRMJRJ11: Centronics receiver, male with RJ-11

1225RMRJ11: Receiver, male DB-25 with RJ-11

1225RFRJ11: Receiver, female DB-25 with RJ-11

AC Powered, Parallel Short Range Modem

Model 1226

Connect a parallel PC to a parallel printer 14 miles (22.5 km) away!

Use this short range modem to connect a parallel PC to a parallel printer located up to 14 miles (22.5 km) away. Interoperates with Models 1050 and 1060 modems (see page 86).



SPECIFICATIONS

Distance: See 1060 Distance Table on Page 157

Transmission Format: Asynchronous serial

Interface: DB-25 female, (IBM) parallel

Data Rate: 0 to 115.2 kbps

Line Interface: RJ-11 & terminal block (RJ-45 opt.)

Applications: Parallel distance extension; parallel to serial or serial to parallel conversion + distance extension (when used with the Model 1060)

Indicators: Tri-state indicators for Transmit Data, Receive Data, Control In and Control Out; One State for Status and Power

Power Supply: External, 10VAC, 700mA

ORDERING INFORMATION

1226-110: Parallel, Powered, Standalone Short Haul Modem (120V)

1226-220: Parallel, Powered, Standalone Short Haul Modem (230V)

FEATURES & BENEFITS

- ✓ Serial Data Rates to 115.2 kbps
- ✓ Distances to 14 Miles over Two Unconditioned Twisted Pair
- ✓ Auto-Directional Serial <=> Parallel Data Conversion
- ✓ Fully Compatible with the Patton Model 1050 and 1060

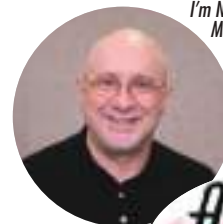

I'm Nathan, Patton's NMS Product Line Manager. If you do not find the solutions you need at www.patton.com or in this catalog, please call me at +1 301.975.1000, x129. You can also send e-mail to nathan@patton.com.



visit us online
www.patton.com

FAST Delivery From Your AUTHORIZED DISTRIBUTOR!

PATTON
Electronics Co.

Baluns

High Speed Baluns

Baluns convert the G.703 interface from unbalanced 75-ohm to balanced 120-ohm terminations. Patton's baluns use dual BNC connectors (Models 460 and 464) or dual 1.6/5.6 coax connectors (Models 465 and 466) for the 75-ohm interface. An RJ-45/48C or terminal block are used for the 120-ohm or 100-ohm interfaces. Patton's balun products are available in standalone and 1U or 2U high 19-inch rack mounts (refer to the selection guides below).

Stand Alone Balun Selection Guide



	Coax Type						Twisted Pair Interface			Model #
	BNC Male	BNC Female	BNC Male on 6 in. cable	1.6/5.6 Male	1.6/5.6 Female	1.6/5.6 Male on 6 in. cable	RJ-45/48C	Terminal Block	Impedance (ohm)	
E1		✓					✓		120	460F
		✓						✓	120	460F-TBP
	✓						✓		120	460M
	✓							✓	120	460M-TBP
			✓				✓		120	460MC
			✓					✓	120	460MC-TBP
					✓		✓		120	465F
				✓			✓		120	465M
						✓	✓		120	465MC
E2		✓					✓		100	462F
	✓						✓		100	462M
E3		✓					✓		120	463F
	✓						✓		120	463M
155 Mbps		✓					✓		100	470F
		✓					✓		120	471F

Rack Mount Balun Selection Guide



Coax Interface (75 ohm)		Twisted Pair Interface (120 ohm)			General Characteristics			Model #
BNC Female	1.6/5.6 Female	RJ-48C	64-Pin Telco	50-Pin Telco	Modular	# of Ports	Height	
✓		✓			Yes	16	2U	460RC/16/F
	✓	✓			Yes	16	2U	465RC/16/F
✓		✓	✓		No	16	1U	464RC
	✓	✓	✓		No	16	1U	466RC
✓				✓	No	24	1U	450RC/24

A Dual Path to Interconnect

Single Port G.703/G.704 Baluns

Single Port E1/E2 IDC Krone Baluns

The new G.703/G.704 insulating displacement connecting (IDC) module Krone baluns are ideal for carriers seeking a cost-effective, space-efficient, and proven method of impedance matching 75-ohm coax to 120-ohm single-conductor connections. The baluns provide transparent bi-directional signal conversion with no AC or battery power required.



75 Ohm (Coax)								120 Ohm Twisted Pair	E1/E2 Balun Model #*
BNC male	BNC female	1.6/5.6 male	1.6/5.6 female	1.0/2.3 male	1.0/2.3 female	BT43 male	BT43 female	Toolless IDC Krone	
✓								✓	431M
	✓							✓	431F
		✓						✓	432M
			✓					✓	432F
				✓				✓	433M
					✓			✓	433F
						✓		✓	434M
							✓	✓	434F

* CALL for additional models.

In This Section

G.703 Baluns 190

Single-Port E1/E2 IDC Krone Baluns	190
G.703 Balun (E1), 2 Mbps with Built-in Cables (75 to 120-ohm)	192
G.703 (E1, E2, E3) Baluns (75 to 120-ohm)	192
G.703 (E1) Balun, 2 Mbps (1.6/5.6 Connectors)	193
155-Mbps ATM Baluns Swap Coax for Twisted Pair	193
G.703 (E1) Balun Panels (75 to 120-ohm)	194
Ultra High Density G.703 (E1) Balun Panel	195
High Density E1/G.703 Balun Panels	196

Legacy Baluns (IBM 3270, AS400) 197

IBM 3270 Coax to Twisted-Pair Baluns	197
Twinax to Twisted-Pair Adapter (Balun)	197

Video Baluns 198

CCTV Passive Baluns	198
CCTV Passive Pass-Thru Baluns	198
CATV Passive Baluns	199
Component Video Balun	199

3270 Balun Selection Guide



Model	Coax Connector		Twisted Pair Connection			
	BNC Male*	BNC Male on 6 inch cable	RJ-11 Jack	Terminal Block	RJ-45 Jack	RJ-11 Plug on 6 feet cable
400M11	✓		✓			
400MTB	✓			✓		
400M11TB	✓		✓	✓		
400M11P	✓					✓
400M45	✓				✓	
400M45TB	✓			✓	✓	
400MC11		✓	✓			
400MCTB		✓		✓		
400MC11TB		✓	✓	✓		
400MC11P		✓				✓
400MC45		✓			✓	
400MC45TB		✓		✓	✓	

* NOTE: For FEMALE BNC connectors, use "F" instead of "M" in Model Number

IBM 3270

IBM 3270 is a star-cabled topology originally designed to be installed with 93-ohm coax cable. Cost, flexibility and space constraints combined with improved balun ("balanced" twisted pair/"unbalanced" coax) technology have made unshielded twisted pair the primary media today. The 400 Series are used to connect terminals and controllers to the 100-ohm twisted-pair cabling.

Single Port E1/E2 IDC Krone Baluns**Patton Model 430 Series G.703/G.704 Baluns**

The Patton 430 Single Port E1/E2 Balun Series provides 75/120-ohm conversion in an ultra-miniature enclosure



The new G.703/G.704 insulating displacement connecting (IDC) module Krone baluns are ideal for carriers seeking a cost-effective, space-efficient, and proven method of impedance matching 75-ohm coax to 120-ohm single-conductor connections. The baluns provide transparent bi-directional signal conversion with no AC or battery power required.

Various industry standard types of coaxial connectors (75 ohm) are available including male and female combinations

of BNC, 1.6/5.6, 1.0/2.3, and Type 43. The 3-pole IDC Krone connector used for wrapping single-conductor connections (120 ohm) utilizes a slit in the cable anchor to allow the cable to be inserted after termination. The IDC Krone connector is also offset so that a cable can be positioned between baluns on the DDF/patch panel as required. The IDC Krone connector is clearly labeled A, B, and G (Ground) to make installation more convenient.



The Patton Model 430R houses up to 32 individual IDC Krone baluns for 16 E1/E2 circuits. The 430R fits into standard 19-inch racks and includes a dry-erase tab for easy and clear marking.

FEATURES & BENEFITS

- ✓ Convert 75 ohm Coax to 120 ohm Twisted Pair—Resolves impedance mis-match between twisted pair equipment and coax cabling
- ✓ Ultra-miniature size—Provides maximum density when installed into a 19-inch (48.3cm) panel
- ✓ Industry Standard Coax Connectors—A host of coax connectors including BNC, 1.6/5.6, 1.0/2.3 and Type 43 are available
- ✓ Low Insertion Loss—Fully meets ITU-T (CTR-12) G.703 standards
- ✓ No Power Required—Operation is transparent to data, no AC/DC power is required



I'm Ovidio, Patton's Regional Director of Latin America Operations. If you have any questions about products or applications using baluns, please call me at +1 301.975.1000, x118, or send e-mail to ovidio@patton.com.

Model 431F

Single Port BNC Female
Panel Mount to IDC
Krone Balun

**Model 431M**

Single Port BNC Male
Panel Mount to IDC
Krone Balun

**Model 432F**

Single Port 1.6/5.6 Female
Panel Mount to IDC
Krone Balun

**Model 432M**

Single Port 1.6/5.6
Male Panel Mount to
IDC Krone Balun

**Model 433F**

Single Port 1.0/2.3 Female
Panel Mount to IDC
Krone Balun

**Model 433M**

Single Port 1.0/2.3 Male
Panel Mount to IDC
Krone Balun

**Model 434F**

Single Port Type 43 Female
Panel Mount to IDC
Krone Balun

**Model 434M**

Single Port Type 43 Male
Panel Mount to IDC
Krone Balun



Balun applications

DDF jumper reconfiguration with 120 ohm

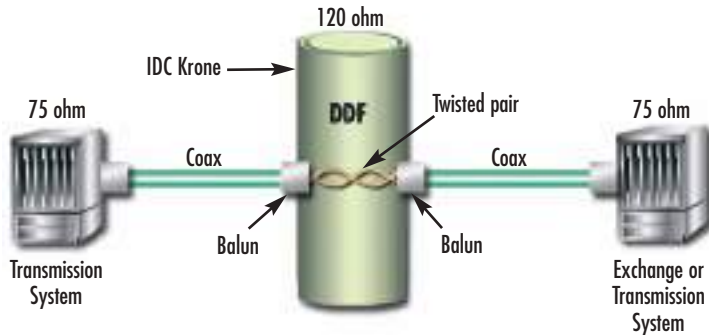

Typical DDF application

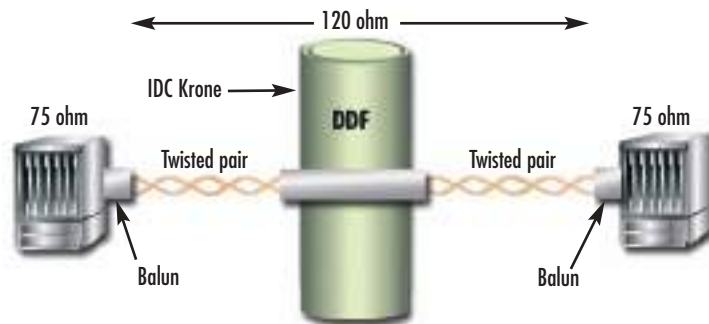

Patton's Ultra-miniature G.703 IDC Krone baluns are fully shielded and are ideal in telecom applications where space is a premium. The Model 430 Series can be panel mounted or cable mounted and feature IDC terminations which allow installation without the need of special tools. Converting your G.703 signal from coax to twisted-pair enables the use of high density IDC modules in the Digital Distribution Frames (DDF), which significantly increases the available density.

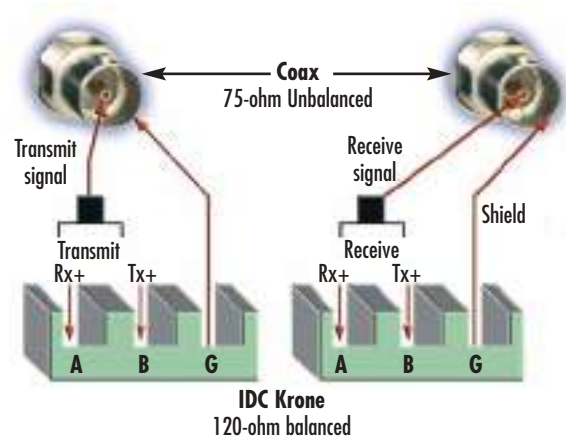

FEATURES

Patton's IDC Krone Connector

- 1 Specially designed tool-less IDC connector for easy connection of unterminated cable.
- 2 IDC Krone connector clearly marked A, B and G for easier installation
- 3 Slit in cable anchor allows cable to be inserted after termination.
- 4 Offset IDC allows cable to be positioned between baluns on DDF as required



With tool-free terminations, clearly marked connectors and well laid out spaces, the Patton IDC Krone connector makes installations a breeze.

ORDERING INFORMATION

- 431F: Single Port BNC Female Panel Mount to IDC Krone Balun
- 431M: Single Port BNC Male Panel Mount to IDC Krone Balun
- 432F: Single Port 1.6/5.6 Female Panel Mount to IDC Krone Balun
- 432M: Single Port 1.6/5.6 Male Panel Mount to IDC Krone Balun
- 433F: Single Port 1.0/2.3 Female Panel Mount to IDC Krone Balun
- 433M: Single Port 1.0/2.3 Male Panel Mount to IDC Krone Balun
- 434F: Single Port Type 43 Female Panel Mount to IDC Krone Balun
- 434M: Single Port Type 43 Male Panel Mount to IDC Krone Balun
- 430R: IDC Krone Mounting Panel

SPECIFICATIONS

Transmission Line: ITU-T G.703/G.704 2-8 Mbps	Cross Talk: Better than -80dB between any two baluns on a DDF strip with 15 mm centers
75-ohm Connection: BNC; 1.6/5.6, 1.0/2.3, or Type 43	Return Loss: -29 dB at 2 Mbps; -21 dB at 8 Mbps
120-ohm Connection: 3 pole IDC Krone	Dimensions: 19L x 1.5W x 3.8H in. (48.3L x 48.3W x 8.9H cm)
Insertion Loss: Max 0.2 dB at 2 Mbps; Max 0.3 dB at 8 Mbps	Weight: 0.4 lbs (0.18 kg)

visit us online
www.patton.com

FAST Delivery From Your AUTHORIZED DISTRIBUTOR!



G.703 Balun (E1), 2 Mbps, With Built-in Cables (75-ohm to 120-ohm)**Model 460MC**

Now you can connect our balun directly to 75-ohm connectors without using special cables. These baluns have 6-in. (15.2 cm) cables for maximum flexibility.

The Model 460MC miniature G.703 balun converts 75-ohm coaxial terminations to 120-ohm terminations, and vice-versa. It can also connect E1 hardware together over inter-building or campus twisted-pair wiring.

The Model 460MC receives 75-ohm signals and converts to 120-ohm for trans-

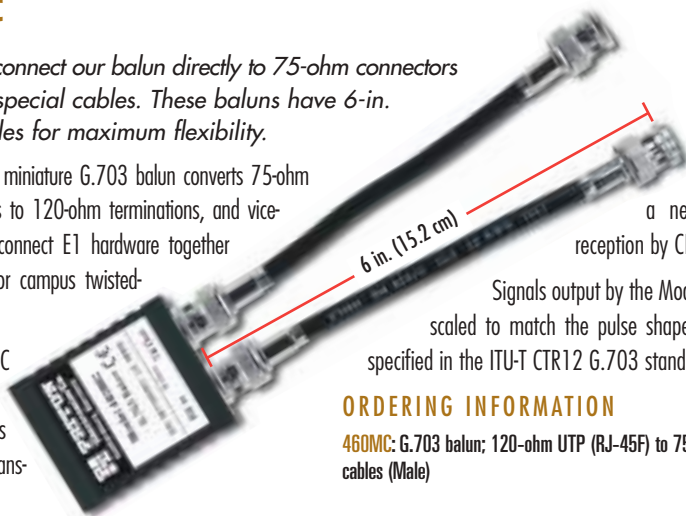

mission over a network or for reception by CPE equipment.

Signals output by the Model 460MC are scaled to match the pulse shape requirements specified in the ITU-T CTR12 G.703 standard.

ORDERING INFORMATION

460MC: G.703 balun; 120-ohm UTP (RJ-45F) to 75-ohm dual-BNC cables (Male)

FEATURES & BENEFITS

- ✓ Solves G.703 termination mis-matches
- ✓ Includes short cables that connect directly to equipment
- ✓ Enables G.703 equipment to use RJ-11 wall plates and operate over standard building wiring
- ✓ Low insertion loss, meets ITU-T (CTR12) G.703 standards
- ✓ Customized versions available upon request
- ✓ Enclosed in flame retardant housings.
- ✓ Baluns are 100% tested for reliability and durability

SPECIFICATIONS

Transmission line: ITU-T CTR12 G.703

Data rate: 2.048 Mbps (models available for rates up to 155 Mbps, call for details)

Link-to-data isolation: 500 volts AC/DC

Op. Temp.: 32–122°F (0–50°C)

Dimensions: 0.8H x 1.7W x 2.7D in. (2.0H x 4.3W x 6.9D cm)

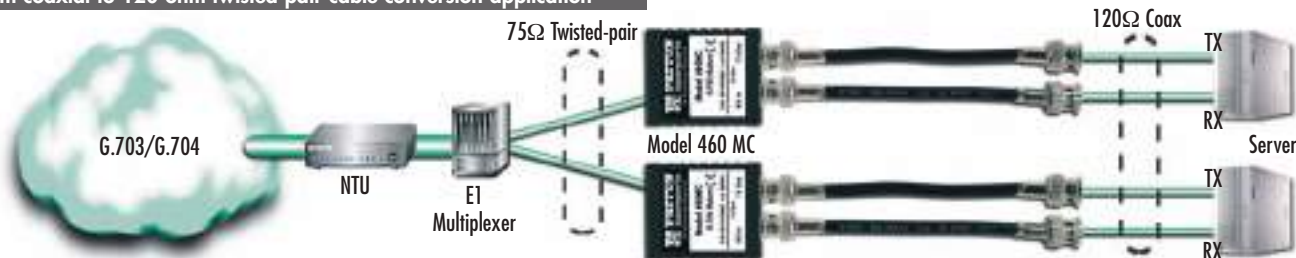
75-ohm coaxial to 120-ohm twisted-pair cable conversion application**G.703 (E1, E2, E3) Baluns (75-ohm to 120-ohm)****Models 460, 462, & 463**

Now you can solve mismatches between coax and twisted pair G.703 terminations!



These devices are miniature G.703 baluns that enable 75-ohm coax hardware to communicate with 120-ohm twisted-pair equipment.

The baluns address ONP requirement that European PTTs offer 120-ohm twisted-pair terminations to their customers. Some PTTs and private carriers are standard-

ized on 75-ohm coax, or have customers whose CPE has only 75-ohm coax connections. Our baluns presents a ready solution to this termination mismatch. A balun receives 75-ohm signals and converts them to 120-ohm for transmission over a network or reception by a CPE.

The output signals from the baluns are scaled to match the pulse shape requirements specified by the CCITT G.703 standard. These baluns can perform 120-ohm to 75-ohm signal conversion as well, thereby fulfilling a dual role.

ORDERING INFORMATION

460F: 2 Mbps, 75-ohm dual-coax (BNC female): to 120-ohm UTP (RJ-45)

460M: Male BNC version of 460

460F-TBP: 2 Mbps, 75-ohm dual-coax (BNC female): to 120-ohm UTP (Terminal Block)

460M-TBP: Male BNC version of 460-TBP

462F: 8 Mbps, 75-ohm dual-coax (BNC female): to 100-ohm UTP (RJ-45)

462M: Male BNC version of 462

463F: 34 Mbps, 75-ohm dual-coax (BNC female): to 120-ohm UTP (RJ-45)

463M: Male BNC version of 463

FEATURES & BENEFITS

- ✓ Data rates to 34 Mbps
- ✓ Available in E1, E2, and E3 varieties
- ✓ 75-ohm dual-coax to 120-ohm twisted-pair
- ✓ Bi-directional signal conversion
- ✓ No AC power or batteries required
- ✓ Male or female coax BNC connectors available
- ✓ Ultra-miniature enclosure

SPECIFICATIONS

Transmission Line: CCITT G.703 (unstructured)

Data Rate: Model 460 to 2 Mbps; Model 462 to 8 Mbps; Model 463 to 34 Mbps

Power Supply: none required
75-ohm Connection: Dual coax BNC connectors, male or female (RG 59 or 2002 coax)

120-ohm Connection: Shielded mRJ-45 jack (internal terminal block included)

Link-to-Data Isolation: 500 volts AC/DC

Op. Temp.: 0–50°C (32–122°F)

Dimensions: 2.7L x 1.7W x 0.8D in. (6.86L x 4.32W x 2.03D cm)

G.703 (E1) Balun, 2 Mbps (1.6/5.6 Connectors)

Models 465 & 465MC

These new G.703 baluns feature 1.6/5.6 coaxial connectors and provide connection for TX and RX connections on a single twisted-pair wire.



Baluns are adapters for connecting mixed cable types or devices with mismatched interfaces. They enable carrier and large-enterprise customers to standardize on twisted-pair wiring, even though some equipment may have unique E1 terminations.

The Model 465 has the 1.6/5.6 coax connectors used extensively in telephone exchange sites. The balun has two interfaces, so that both the TX and RX coax signals can be carried over a single length of twisted-pair cabling (which is far less costly than any kind of coaxial cable).

ORDERING INFORMATION

465F: G.703 balun; 120-ohm UTP (RJ-45F) to 75-ohm dual-coax female 1.6/5.6 plugs

465M: G.703 balun; 120-ohm UTP (RJ-45F) to 75-ohm dual-coax male 1.6/5.6 plugs

465MC: G.703 Balun with 120-ohm UTP (RJ-45F) to 75-ohm 1.6/5.6 plugs 6-in. (15.2 cm) cables

FEATURES & BENEFITS

- ✓ Use 120-ohm twisted-pair wiring with unbalanced coaxial equipment
- ✓ No more buying expensive and space-hungry hardware for patching and distributing G.703 connections
- ✓ Low cost model supports rates of 2 Mbps
- ✓ Low insertion loss, fully meets ITU-T (CTR12) G.703 standards
- ✓ Standard twisted-pair terminations
- ✓ Enclosed in flame retardant housings
- ✓ Baluns are 100% tested for reliability and durability
- ✓ Customized versions available upon request

SPECIFICATIONS

Transmission line: ITU-T CTR12 (G.703)
Data rate: 2.048 Mbps
Link-to-data isolation: 500 volts AC/DC
Op. Temp.: 32° to 122°F (0° to 50°C)

Dimensions:
 0.8H x 1.7W x 2.7D in.
 (2.0H x 4.3W x 6.9D cm)

Coax to twisted-pair building wiring conversion

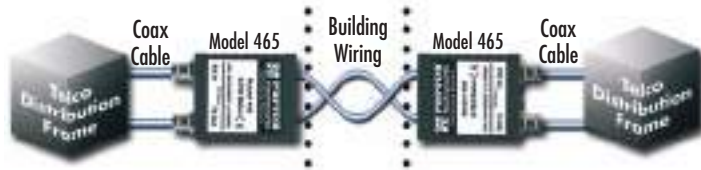

Coax to twisted-pair cable conversion



155-Mbps ATM Baluns Swap Coax for Twisted Pair

Models 470, 471, & 472

Match 75-ohm dual-coax with a 100-, 120-, or 150-ohm twisted-pair wiring

These baluns enable you to match the connectors, impedance, and signal characteristics of a wide variety of connections. The Models 470 (100-ohm) and 471 (120-ohm) provide RJ-45 for twisted-pair. The Model 472 (150-ohm) provides an IBM data connector on a pigtail.



ORDERING INFORMATION

470F: ATM Balun (75-ohm Dual-Coax BNC female to 100-ohm shielded RJ-45 jack)

471F: ATM Balun (75-ohm Dual-Coax BNC female to 120-ohm UTP RJ-45 jack)

472F: ATM Balun (75-ohm Dual-Coax BNC female to 150-ohm IDC on pigtail)

FEATURES & BENEFITS

- ✓ Support for data rates to 155 Mbps
- ✓ Bi-Directional signal conversion
- ✓ 75-ohm dual-coax BNC (female)
- ✓ Model 470 (100 ohm) & Model 471 (120 ohm) provide RJ-45 for twisted-pair; Model 472 (150 ohm) provides IBM data connector on pigtail

SPECIFICATIONS

Data rate: Up to 155 Mbps
Link-to-data isolation: 500 volts AC/DC
Op. Temp.: 32–122°F (0–50°C)

Dimensions:
 0.8H x 1.7W x 2.7D in.
 (2.0H x 4.3W x 6.9D cm)

TeleMatch™ G.703 (E1) Balun Panels (75 to 120-ohm)**Models 460RC & 465RC**

Modular Construction Lets You Add up to 16 Separate G.703 Balun Modules

The TeleMatch G.703 rack mount balun panels let you match the connectors, impedance and signal characteristics of up to 16 dual coax connections (75 ohm) with up to 16 twisted pair connections (120 ohm). Operating in compliance with the CCITT G.703 specification, the panels occupy only 2U (3.5 in./8.9 cm) of vertical rack space in a 19 in. (48.3 cm) rack—allowing for efficient multipoint matching.

The Model 460RC rack mount balun panel comes with 16 dual coax BNC connectors. The Model 465RC has the 1.6/5.6 coax connectors used extensively in telephone exchange sites.

What's more, the Model 460RC is modular, meaning that each balun can be added separately. Purchase an entire panel fully populated with 16 balun modules (Model 460RC/16/F or 465RC/16/F). Or purchase the chassis separately (Model 460R/16) and add balun modules (Model 460RC/F or 465RC/F) as you need them. On individual twisted pair ports, shield-to-pin and shield-to-ground connections are strap selectable. So you are not locked into the same configuration for every balun in the panel. If you need to do multiple 75 ohm to 120 ohm conversions, the Model 460RC is definitely the way to go!

FEATURES & BENEFITS

- ✓ Connects 75-ohm dual coax to 120-ohm twisted pair (or visa versa)
- ✓ Use 120-ohm twisted-pair wiring with unbalanced coaxial equipment
- ✓ Dual female coax BNC connectors (Model 460RC)
- ✓ Uses 1.6/5.6 coaxial connectors (Model 465RC)
- ✓ Bi-directional signal conversion according to CCITT G.703
- ✓ Supports rates of 2 Mbps (E1)
- ✓ Strap-selectable grounding option
- ✓ Low profile design
- ✓ Mounts in standard 19 in. (48.3 cm) rack
- ✓ No AC power or batteries required
- ✓ Strap-selectable modular (RJ-45) pinouts
- ✓ No more buying expensive and space-hungry hardware for patching and distributing G.703 connections
- ✓ Low insertion loss, fully meets ITU-T (CTR12) G.703 standards
- ✓ Standard twisted-pair terminations
- ✓ Baluns are 100% tested for reliability and durability

SPECIFICATIONS**Transmission Line:**

Model 460RC—CCITT G.703 (unstructured)

Model 465RC—ITU-T CTR12 G.703

Data Rate:

Model 460RC—2.048 Mbps

Model 465RC—2.048 Mbps

120 ohm Connection: Shielded RJ-45 jack

Power Supply: none required

75-ohm Connection:

Model 460RC—Dual female BNC connectors

Model 465RC—Dual female 1.6/5.6 connectors

Link-to-Data Isolation: 500 Volts AC/DC

Op. Temp.: 32–122°F (0–50°C)

Dimensions:

19.0W x 3.5H x 1.9D in.

(48.3W x 8.9H x 4.8D cm)

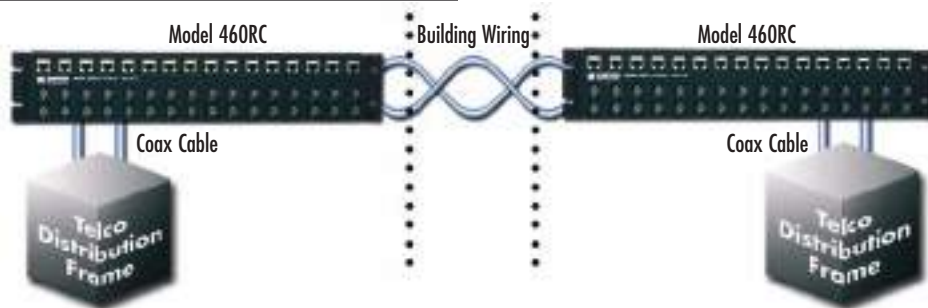
**Coax to twisted-pair building wiring conversion****Coax to twisted-pair cable conversion****ORDERING INFORMATION**

460RC/16/F: 16-Port G.703 Balun Panel (RJ-45 Jack to Dual BNC Female)

460R/16*: Balun Chassis (Empty)

460RC/F: G.703 Balun Module, RJ-45 to Dual BNC Female

465RC/16/F: 16-port G.703 Balun Panel, RJ-45 to Dual 1.6/5.6 Female

465RC/F: G.703 Balun Module, RJ-45 to Dual 1.6/5.6 Female

Ultra High Density G.703 (E1) Balun Panel

Model 450RC24

The Patton Model 450RC24 Ultra High-Density 24 Port Balun Provides Flexible 75/120-ohm Telco Interfacing Solutions for E1 Networks



The Patton 450RC24 G.703 balun panel matches 24 sets of dual 75-ohm coax connections to 120-ohm 50-pin telco connections. This feature allows network & datacom equipment manufacturers who are selling equipment for use in COs with only 120-ohm telco interfaces to offer their equipment to G.703 countries using 75-ohm connections. This eliminates the mismatch with coax legacy equipment in many COs.

Supporting E1 data rates to 2.048 Mbps, the Patton 450RC24 panel bi-directionally matches signal impedance and pulse shapes according to the CCITT G.703 standard. The Patton 450RC24 balun panel mounts in a standard 19-inch (48.3-cm) rack, occupies only 1U of rack space, and includes a reversible top cover for front-facing BNCs or 50-pin telco connectors.

FEATURES & BENEFITS

- ✓ Connects 24 75-ohm dual BNC to 120-ohm dual 50-pin telco connectors
- ✓ Bi-directional signal conversion according to CCITT G.703
- ✓ Data rates up to 2.048 Mbps
- ✓ 1U high chassis, mounts in standard 19-in. rack
- ✓ Reversible cover with integrated mounting ears
- ✓ No AC power or batteries required
- ✓ 24 female BNC coax pairs
- ✓ Dual 50-pin telco 120-ohm connectors
- ✓ 6-inch BNC removal tool

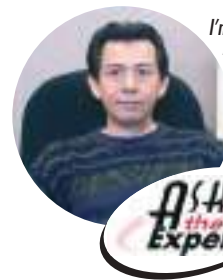

I'm Jose, Patton's Technical Solutions Manager for Latin America. If you have any questions about products or applications using these technologies, please call me at +1 301.975.1000, x142, or send e-mail to jose@patton.com.

Typical application



SPECIFICATIONS

Electrical Characteristics
Averaged between 1 MHz and 3 MHz
Avg. Cross Talk: Better than 54.4 dB (Between adjacent channels (TX and RX))
Avg. Insertion Loss: Less than .30dB
Avg. Return Loss: Better than 31.5dB

Physical Specifications
Transmission Line: CCITT G.703 (unstructured)
Data Rate: 2.048 Mbps
75 ohm Connection: Dual coax female BNC connectors
120 ohm Connection: Dual 50-pin Telco connectors

Power Supply: none required
Link-to-Data Isolation: 500 volts AC/DC
Op. Temp.: 32–122°F (0–50°C)
Relative Humidity: 5–95% RH, non-condensing
Altitude: 0–15,000 feet (3,048 meters)

Dimensions (without handles): 19W x 3.5H x 1.9D in. (48.3W x 8.9H x 4.8D cm)
Weight: 4.46 lbs (2.02 kg)

ORDERING INFORMATION

450RC/24: E1/G.703 Ultra High Density 24-port, Dual 50-pin Telco Balun Chassis (BNC Coax)

visit us online
www.patton.com

FAST Delivery From Your AUTHORIZED DISTRIBUTOR!



High Density, E1/G.703 Balun Panels**Models 464RC & 466RC**

Matches 16 sets of dual 75-ohm coax connections to 120-ohm twisted pair connections



The Patton 464RC & 466RC G.703 balun panels match 16 sets of dual 75-ohm coax connections to 120-ohm twisted-pair connections. This function allows carriers to provide 120-ohm G.703 service to customers retaining 75-ohm CPE hardware. It also allows carriers who have standardized on 75-ohm coax to provide 120-ohm terminations to their customers (in keeping with European ONP requirements).

Supporting E1 data rates to 2.048 Mbps, the Patton 464RC and 466RC panels bi-directionally match signal impedance and pulse shapes according to the CCITT G.703 standard. The Patton 464RC and 466RC balun panels mount in a standard 19-in. (48.3 cm) rack. Includes a reversible top cover for front-facing BNC or front-facing RJ-45/AMP Champ connectors.

FEATURES & BENEFITS

- ✓ Connects 16 75-ohm dual coax to 120-ohm twisted pair channels
- ✓ Bi-Directional signal conversion according to CCITT G.703
- ✓ Data Rates up to 2.048 Mbps
- ✓ 1U-high enclosed chassis
- ✓ Reversible cover with integrated mounting ears
- ✓ Mounts in standard 19 in. (48.3 cm) rack
- ✓ No AC power or batteries required
- ✓ Female BNC coax (Model 464RC)
- ✓ Female 1.6/5.6 connectors (Model 466RC)
- ✓ RJ-45 and 64 pin AMP Champ 120-ohm interface

ORDERING INFORMATION

464RC: High density 16-port, 19-inch, 1U (4.44 cm) balun chassis. BNC coax connector for 75-ohm connections. G.703 rack-mount

466RC: High density 16-port, 19-inch, 1U (4.44cm) balun chassis. 1.6/5.6 coax connector for 75-ohm connections. G.703 rack-mount

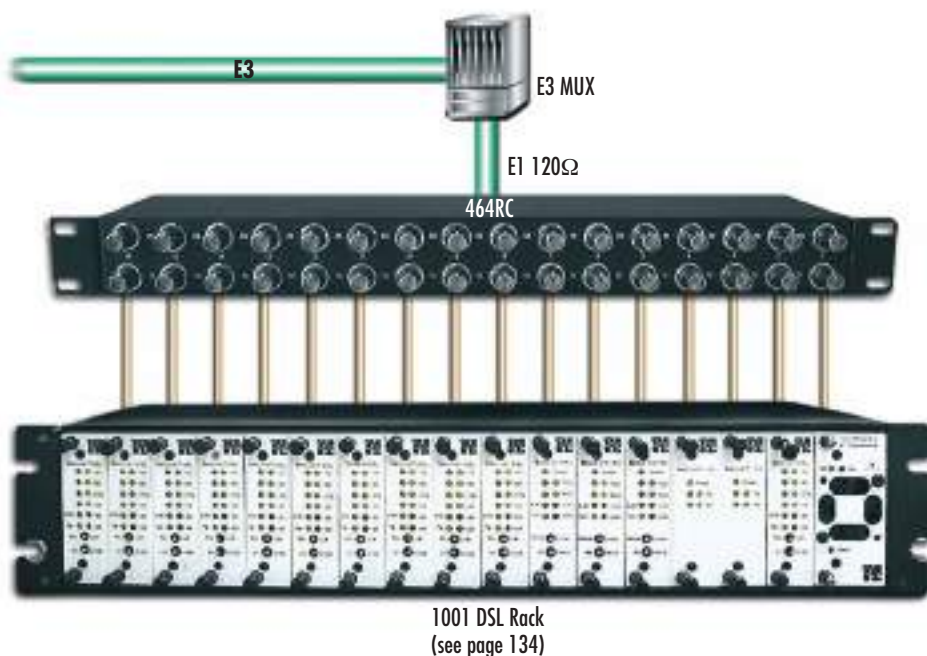
Typical application**SPECIFICATIONS**

Transmission Line: CCITT G.703 (unstructured)

Data Rate: 2.048 Mbps

75 ohm Connection: Dual coax female BNC (464) 1.6/5.6 series (466) connectors

120 ohm Connection: RJ-45 jack or 64 pin AMP Champ

Power Supply: none required
Link-to-Data Isolation: 500 volts AC/DC

Op. Temp.: 32-122°F (0-50°C)
Dimensions (without handles): 19.0 W x 1.75 H x 1.9 D in. (48.3 W x 4.45 H x 4.8 D cm)

Looking for a *Standalone Balun Solution?* See Page 192

Check out our
Ultra-Miniature G.703 Baluns



IBM 3270 Coax to Twisted Pair Baluns

Model 400

Why run expensive coax cable when you can use twisted pair?

With a pair of Patton Model 400 baluns, any IBM 3270 Type A device can be connected over one twisted pair telephone line at distances up to 1,200 feet (365 m). This can result in significant savings over coax!

FEATURES & BENEFITS

- ✓ Communicate over existing telephone lines or other twisted pair
- ✓ Connect twisted pair using RJ-11, RJ-45 or terminal block
- ✓ Available with 6-in (0.15 m) coax and/or 6-ft (1.8 m) twisted-pair pigtails (custom lengths are also available)
- ✓ Distances to 1,200 feet (365 m) on 24 AWG wire (1,500 ft on 22 AWG wire)



Model 400MC11
Coax Balun with
RJ-11 Jack

Model 400M11P
Coax Balun with
RJ-11 Plug on a 6-ft
(1.8 m) Modular Cable

Twinax to Twisted Pair Adapter (Balun)

Models 410

Use twisted pair instead of expensive Twinax!

Twinax cable for IBM Systems 34/36/38 and AS/400 is not only cumbersome to install, it is also costly. With the Patton Model 410, you can use standard, inexpensive twisted pair telephone wire instead of Twinax cable. It is less expensive and much easier to handle.

FEATURES & BENEFITS

- ✓ Connects Twinax AS/400 to inexpensive twisted pair
- ✓ Supports distances of 1,000 feet (3,048 m) on 24 AWG wire



ORDERING INFORMATION

Balun with BNC Male Coax Connector; twisted pair connection is shown below

400M11: RJ-11 Jack

400MTB: Terminal Block (TB)

400M11TB: RJ-11 Jack and TB

400M11P: RJ-11 Plug on 6-ft (1.8 m) Cable

400M45: RJ-45 Jack

400M45TB: RJ-45 Jack and TB

Balun with BNC Male Coax Connector on 6-in. (1.8 m) cable; twisted pair connection is shown below

400MC11: RJ-11 Jack

400MCTB: Terminal Block

400MC11TB: RJ-11 Jack and TB

400MC11P: RJ-11 Plug on 6-ft (1.8 m) Cable

400MC45: RJ-45 Jack

400MC45TB: RJ-45 Jack and TB

Note: For female BNC coax connectors, replace "M" with "F" in Model Number when ordering—Same Prices!



ORDERING INFORMATION

Twinax Balun with 75-ohm Dual-Coax BNC (Female); twisted pair connection is shown below

410M11: RJ-11 jack

410MTB: Terminal block (TB)

410M11TB: RJ-11 jack and TB

410M11P: RJ-11 plug on 6 ft (1.8 m) cable

410M45: RJ-45 jack

410M45TB: RJ-45 jack and TB

CCTV Passive Baluns**Model 310 Series**

Why use expensive and difficult-to-manage coax cabling when you can use inexpensive twisted-pair?

The Model 310M CCTV Modular Balun allows a single composite CCTV video signal to be transmitted

via a single unshielded twisted pair for more versatile security and surveillance cabling. Used in pairs, the CCTV Balun eliminates costly and bulky coax cable.

SPECIFICATIONS

UTP: 24 gauge or lower, twisted pair
Impedance: 100 ohm at 1 MHz
Max. Capacitance: 20 pF/ft
Attenuation: 6.6 dv/1000 feet at 1 MHz
BNC: Impedance: 75 ohm at 1 MHz (RG-59)
Bandwidth: Video DC to 8 MHz
Maximum Input: 1.1 Vp-p

Impedance: 75 to 100 ohm
Insertion Loss: Max 2 dB per pair over frequency range from DC to 8 MHz
Return Loss: Greater than 15 dB over the frequency range from DC to 8 MHz
Common mode rejection: Greater than 40 dB at 8 MHz
Active Pins: 8+ 7-

ORDERING INFORMATION

310M: CCTV BNC male to TB/RJ45; wiring 8+, 7-

310F: CCTV BNC female to TB/RJ45; wiring 8+, 7-

311M: CCTV std type balun for indoor BNC male to RJ45

312M: CCTV std type balun for outdoor BNC male to RJ45

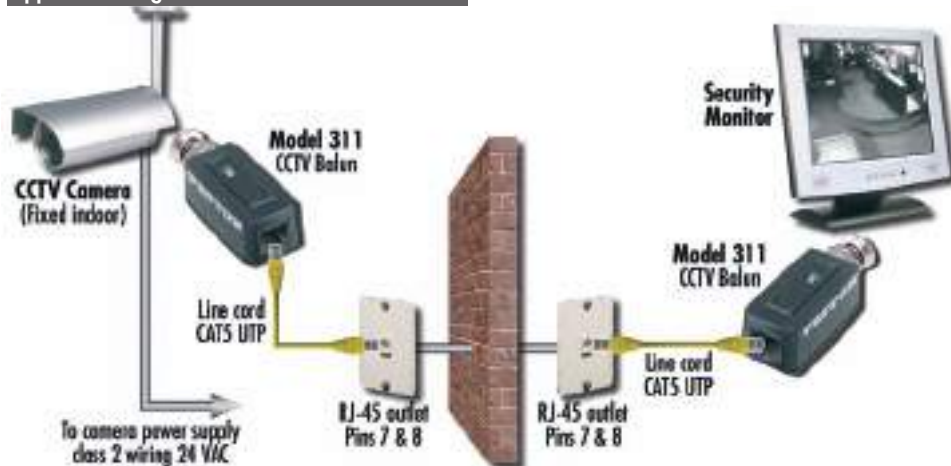
Application diagram**FEATURES & BENEFITS**

- ✓ Communicate over existing telephone lines or other twisted pair media
- ✓ Connect twisted pair using RJ45 or terminal block
- ✓ Distances up to 2,230 feet (680 meters) over Cat5 cable
- ✓ No AC or power required and supports bi-directional signal conversion

CCTV Passive Pass-Thru Baluns**Model 320 Series**

Pass power, PTZ, and video over a single Cat 5 cable.

Patton's CCTV Pass-Thru Balun allows video, 2-wire pan/tilt/zoom (PTZ) control and remote power to be transmitted via one 4-pair Cat5 cable eliminating the need to install multiple cables in the CCTV security and surveil-



lance environment. The pass-thru balun may be used in pairs or in conjunction with standard twisted pair cross-connect devices and other Patton CCTV baluns.

FEATURES & BENEFITS

- ✓ Distances up to 2,230 feet (680 meters) over Cat5 cable

SPECIFICATIONS

Except for the following, specifications are the same for Model 320 and Model 310
Max. Distance: 24 VAC via three pairs with 10% voltage drop at camera
 5VA: 519 feet (170 meters)
 10VA: 258 feet (85 meters)
 20VA: 130 feet (43 meters)
 30VA: 86 feet (28 meters)
Max Input Voltage: 50V (AC RMS/DC)

Max Current Rating: 4.5A (AC RMS/DC)

Active Pins:

Model 320: 8+ 7- (video), 1 2 3 4 5 6 (power)

Model 321: 8+ 7- (video), 1 2 3 6 (power), 4, 5 (data, PTZ control)

Model 322: 8+ 7- (video), 4 5 3 6 (data, speed dome)

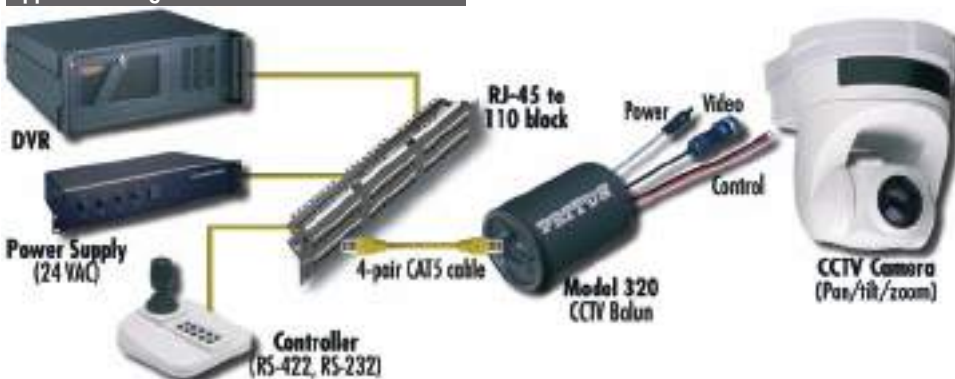
Application diagram**ORDERING INFORMATION**

320P: CCTV Balun RJ45 Power-thru type Male w/DC power plug, 8+7- (video), 123456 (power)

320J: CCTV Balun RJ45 Power-thru type Male w/DC power Jack, 8+7- (video), 123456 (power)

320: CCTV Balun RJ45 Power-thru type Male w/o DC power Plug and Jack, 8+7- (video), 123456 (power)

321P: CCTV Balun RJ45 Power-thru type Male w/DC power plug, 8+7- (video), 1236 (power), 4, 5 (data, PTZ control)

321J: CCTV Balun RJ45 Power-thru type Male w/DC power jack, 8+7- (video), 1236 (power), 4, 5 (data, PTZ control)

322: CCTV Balun RJ45 Power-thru type Male w/o DC power Jack, 8+7- (video), 4536 (data, speed dome)

CATV Passive Baluns

Model 330 Series



Model 330MP shown

Why use expensive and hard-to-manage coax cables when you can use inexpensive twisted-pair?

Patton's 330 Series CATV Baluns enable one CATV, VHF, and FM video signal to be transmitted via one twisted-pair cable in a

point-to-point connection. The CATV balun saves the cost of installing expensive and bulky coax cable and is a smart, fast way of connecting RF video equipment to TVs, monitors, and other RF equipment.

Application diagram

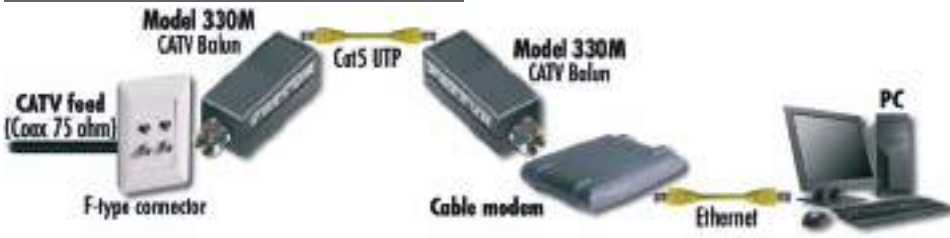

FEATURES & BENEFITS

- ✓ Communicate over existing telephone lines or other twisted pair media
- ✓ Connect twisted pair using R-J45 or terminal block
- ✓ Distances up to 328 feet (528 meters) over Cat5 cable

SPECIFICATIONS

UTP: 24 gauge or lower, twisted pair
 Impedance: 100 ohm
 Pins: 7 & 8
 F Connector: Impedance: 75 ohm
 Bandwidth: 5 to 862 MHz
 Insertion Loss: Less than 3 dB (5 dB max. for CATV 2-27)

Return Loss: More than 18 dB from 10 to 862 MHz

Common mode rejection: More than 20 dV from 40 to 862 MHz

Max. Distance: 197 feet (60 meters) over Cat5; 328 feet (100 meters) with amplifier

ORDERING INFORMATION

330F: F Male to RJ45 Jack, wiring 8+/-

330MP: PAL Male to RJ45 Jack, wiring 8+/-

331F: F Female to Toolless IDC with cover

331M: F Male to Toolless IDC with cover

331FP: PAL Female to Toolless IDC with cover

331MP: PAL Male to Toolless IDC with cover

Component Video Balun

Model 350



Simplify and extend your audio/video signals over a single Cat 5 cable.

Patton component video + digital audio balun allows one component video (YPbPr or RGB) signal and one digital audio sig-

nal to be transmitted via one Category 5 Shielded twisted pair cable for more cost-efficient cabling. Used in pairs, the Model 350AV supports 480i/p, 720p and 1080i/p video formats for hi-definition (HDTV) video applications.

Application diagram



FEATURES & BENEFITS

- ✓ Communicate over existing telephone lines or other twisted pair media
- ✓ Supports 480i/p, and hi-definition (HDTV) formats 720p, 1080i, and 1080p
- ✓ Distances up to 1,000 feet (305 meters) over Cat5 cable

SPECIFICATIONS

UTP: 24 gauge or lower solid copper twisted pair wires impedance: 100 ohms at 1 MHz

Max. capacitance: 20 pf per foot.

Attenuation: 6.6 dB/1000 ft at 1 MHz
 Coax (RCA): Impedance: 75 ohms at 1 MHz 30VA: 86ft (28m)

Connectors: Three RC A-M connectors: Green (Y), Blue (Pb), Red (Pr), One

(1) RCA-F connector for digital audio to RJ45 Socket for twisted pair

Pin Configuration: Red (Pr): Pins 7+, 8- Green (Y): Pins 6+, 3-; Blue (Pb): Pins 2+, 1--Digital Audio: Pins 5+, 4-

Distance: 480i/p: 1,000 feet (305 meters). 720p and 1080i: 500 feet (152 meters). Digital Audio: 600 feet (182 meters)

ORDERING INFORMATION

350: Component Video Balun

Line Drivers

Short-Range Modems and Modem Eliminators

Self-Powered Line Drivers

ASync

DB-25, DB-9, DB-15



to 19.2 kbps
17 miles
(27 km)

Model 1000, 1009, 1015
Page 203

ASync/MULTIDROP

DB-25, DB-9



to 115.2 kbps
9 miles
(14.5 km)

Model 1004A/1008
Page 205

Sync



to 19.2 kbps
11 miles
(17.7 km)

Model 1020
Page 207

Sync & ASync

Low Speed



to 38.4 kbps
12 miles
(19.3 km)
Multi-Drop

Model 1040
Page 206

Powered Line Drivers

LOW SPEED UNITS

Basic



to 38.4 kbps
14 miles
(22.5 km)

Model 1050
Page 210

Multipoint



to 115.2 kbps
14 miles
(22.5 km)

Model 1060
Page 210

Long Range & Multipoint



to 64 kbps
17 miles
(27 km)

Model 1080A
Page 212

Fiber Modems

ASync RS-232



to 19.2 kbps
5 miles
(8 km)

Model 1110A
Page 216

ASync RS-485



to 115.2 kbps
1.25 miles
(2.01 km)

Model 1104
Page 216

ASync/Sync RS-232



to 38.4 kbps
4 miles
(6.4 km)

Model 1140A
Page 216

Modem Eliminators

ASync



Null Modem
Adapters

Model 6
Page 241

Sync RS-232

Low Speed



300 ft (91 m)
Extension

Model 1200
Page 214

to 512 kbps



150 ft (46 m)
Extension

Model 1202
Page 214

Going the Distance

SYNC & ASYNC

High Speed



to 64 kbps
6 miles
(9.7 km)

Model 1045
Page 209

PARALLEL

Wire Speed



2,000 feet
(610 m)

Model 1225
Page 208

INDUSTRIAL MODEMS FOR OUTDOOR USE

Temp: 32 to 158°F (0 to +70°C)

Temp: 14 to 158°F (-10 to +70°C)



Environmentally
ruggedized sync./async.
baseband modems

Model 1065A (Standard Temp/Humidity)
Page 213

Model 1065E (Extended Temp/Humidity)
Page 213

USB & Wireless Modems

USB



to 196 feet
(60 m) over
Cat5e cable

Model 110
Page 202

WIRELESS



to 380 kbps
3,900 feet
(1,188 meters)

Model 1013
Page 217

V.35



to 144 kbps
300 ft (91 m)
Extension

Model 1205
Page 215

X.21



to 144 kbps
300 ft (91 m)
Extension

Model 1206
Page 215

In This Section

Self-Powered Line Drivers 202

High-Speed Serial Extender & RS-232 Serial Extender	202
USB 1.1 Extender Kit	202
SRM, Async Point-to-Point, 19.2 kbps	203
SRM, Transformer Isolated, 4 Wire to RS-232 ...	203
SRM, Full-Duplex, 2 Wire to RS-232, 19.2 kbps ..	204
SRM, Full-Duplex, Carrier Sense, 19.2 kbps, 2 Wire	204
SRM, Multipoint, 2/4 Wire, 115.2 kbps	205
SRM, Multipoint, 2/4 Wire, 115.2 kbps, Rack Card	205
SRM, Async, 38.4 kbps	206
SRM, Async, 38.4 kbps, Rack Card	206
SRM, Sync/Async, 38.4 kbps	206
SRM, Sync Point-to-Point, 19.2 kbps	207
SRM, Sync, 64 kbps	208
Line Extenders	208
SRM, Sync/Async, RS-232 & RS-530, 64 kbps ..	209
SRM, Sync/Async, RS-232 & RS-530, 64 kbps, Rack Card	209
SRM, Async with Extra Controls, 57.6 kbps	209

Powered Line Drivers 210

SRM, Async, 38.4 kbps	210
SRM, Async, 115.2 kbps	210
SRM, Sync, Opto-Isolated, RS-232, 19.2 kbps ...	211
SRM, Sync, Opto-Isolated, RS-232, 19.2 kbps, Rack Card	211
SRM, Sync, Opto-Isolated, X.21, 64 kbps	211
SRM, Sync/Async, 2/4 Wire, Half/Full Duplex ...	212
SRM, Sync/Async, 2/4 Wire, Half/Full Duplex, Rack Card	212
SRM, Baseband, Ruggedized for Outdoor Use, 64 kbps	213

Modem Eliminators 214

Sync, 38.4 kbps, Self Powered	214
Sync, 224 kbps, Self Powered	214
Sync, 512 kbps, Self Powered	214
V.35 or X.21, Sync, 144 kbps	215
V.35 or X.21, Sync, 144 kbps, Rack Card	215
Anti-Streaming Device	215

Fiber Modems 216

RS-232, Async, 19.2 kbps	216
RS-232, Async, 19.2 kbps, Rack Card	216
RS-233, Async or Sync, 38.4 kbps	216
RS-233, Async or Sync, 38.4 kbps, Rack Card ..	216

Wireless Short Range Modems 217

RS-232 Bluetooth Wireless Modem 2-Packs	217
---	-----

High Speed Serial Extender & RS-232 Serial Extender**Models 1053AF & 1052AF**

These miniature high-speed digital modems offer multi-rate Async/Sync while transparently passing modem control signals. Both 2-wire full-duplex modems use 2B1Q modulation for superior noise immunity.



The 1053AF and 1052AF are long-range, powered, digital modems that operate synchronously or asynchronously at full duplex over a single twisted pair. The 1053AF operates at multi-rate async/sync speeds up to 115.2/128 kbps; the 1052AF at speeds up to 38.4/128 kbps. Both modems utilize 2B1Q modulation for superior signal strength, even in the noisiest environments. RS-232 serial connections with speeds

of 128 kbps can now be extended to distances over 5 miles (8 km) without the use of repeaters! Using ordinary voice-grade wire, the serial extenders provide a cost-effective solution for high speed, dedicated, end-to-end connections with synchronous line rates up to 128 kbps and asynchronous line rates up to 115.2 kbps (1053AF) or 38.4 kbps (1052AF) that include RTS, CTS and DCD modem signals.

The modems' miniature size allow for a direct connection to your transmission device's serial port. Two 8-position DIP switches enable configuration of asynchronous or synchronous line rate settings. Additionally, LEDs are conveniently located on the side of the modems to provide at-a-glance status indication of the unit.

Application diagram

The Model 1053AF and Model 1052AF offer premium performance using the most common, inexpensive cabling infrastructure in the world, voice-grade telephone wire. Using 2B1Q modulation a serial port can be extended to distances of over 5 miles (8 km).

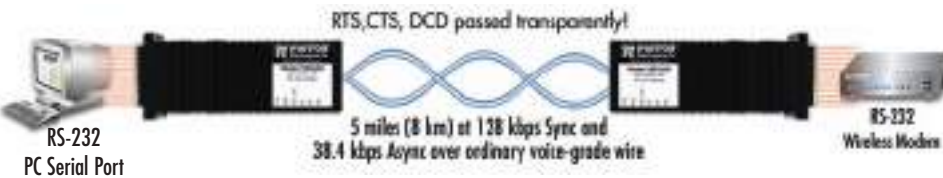
**FEATURES & BENEFITS**

- ✓ Multi-Rate Speeds — **1053AS**: Full-duplex synchronous rates to 128 kbps and asynchronous rates to 115.2 kbps
1052AS: Full-duplex synchronous rates to 128 kbps and asynchronous rates to 38.4 kbps.
- ✓ Extends serial devices up to 5 miles (8 km) over ordinary grade twisted pair
- ✓ Pass RS-232 Control Signals—Transparently passes CTS, RTS, and DCD over the 2-wire line.
- ✓ Long Reach—Industry leading distances of over 26,000 feet (8 km) without repeaters.

ORDERING INFORMATION

1052/AF/UI: Async 38.4/Sync 128 kbps RS-232 Extender
1053/AF/UI: Async 115.2/Sync 128 kbps RS-232 Extender

SPECIFICATIONS

Clocking: Internal, external, or receive recover.

Line Coding: 2B1Q conforming to ANSI T1.601 and ETSI ETR-080 standards.

Line Interface: RJ-45; Two-wire twisted-pair using pins 4 & 5; Transformer coupled 1500 VRMS isolation

Maximum Line Distance for All Data Rates: 10.1 miles (16.4 km) on 19 AWG (0.9 mm) wire • 7.2 miles (11.5 km) on 22 AWG (0.64 mm) wire • 5.0 (8 km) on 24 AWG (0.5 mm) wire • 3.4 (5.5 km) on 26 AWG (0.4 mm) wire

Serial Interface: DB-25 Female or DB-9 Female depending on model ordered.

Serial Data Rates:
1083AS: Synchronous: 2, 56, 64, and 128 kbps • Asynchronous: 38.4, 57.6, 76.8, and 115.2 kbps
1052AS: Synchronous: 32, 56, 64, and 128 kbps • Asynchronous: 0–38.4 kbps.
LED Indicators: TXD, RXD, Link, NS (no signal), ER (CRC error)

Power Supplies: External wall-mount power supply with universal 90–260 VAC input or -12, -24, and -48 VDC input

Dimensions: 5.18L x 1.69W x 0.75H in. (13.16L x 4.29W x 1.91H cm)

Weight: 2.01 lbs. (<1.0 kg)

Compliance: EMC: FCC Part 15, sub-part B, class A (US) • EMC Directive 89/336/EEC (EU) • ICES-003 (Canada) • AZ/NZS 3548 (Australia C-Tick) • CISPR 22 (International)

Safety: UL 60950/CAN-ISA-C22.2 60950 (Safety—US/Canada) • EN 60950 (Safety—Europe/International)

Operating temp.: 32–122°F (0–50°C)

Humidity: 5–95% non-condensing
Altitude: 0–15,000 feet (0–4,572 meters)

USB 1.1 Extender Kit**Model 110**

Extends the distance of a USB device to a host computer up to 196 feet (60 m) over Cat5e cable

Patton's Model 110 overcomes USB length limitations of 16 feet so that you have the flexibility to locate your USB printer, camera, web cam or any other USB device where you want them. The Model 110 extends the distance of a USB device to a host computer up to 196ft (60m) over Cat5e. The 110 is plug-and-play with absolutely no special software or drivers to install.

ORDERING INFORMATION

110-KIT: USB Extender Kit

0805XXX: USB Power Supply

**FEATURES & BENEFITS**

- ✓ Fully compliant with USB 1.1 specifications
- ✓ Provides support for any full speed (12 Mbps) or low speed (1.5 Mbps) USB devices
- ✓ No software required
- ✓ USB LED indicator for quick glance status checks

SPECIFICATIONS

USB: Fully compliant to USB 1.1

Rates: Full speed (12 Mbps)/Low speed (1.5 Mbps)

Connector:

- Local Unit: USB Type A Male; RJ-45
- Remote Unit: USB Type A Female; RJ-45

Active Pins: Power 1 & 4; Data 2 & 3

Distances:

- **Cat 5**: non-powered 98 ft (30m)

• **Cat 5**: powered 165ft (50m)

• **Cat 5e/6**: non-powered 196 feet (60 m)

• **Cat 5e/6**: powered 263 feet (80 m)

Operating temp.: 32 to 104°F (0 to 40°C)

Storage temp.: -40 to 185°F (-40 to 85°C)

Basic Point-to-Point Async SRMs

Models 1000 & 1009

The Model 1000 async short range modem plugs directly into a DB-25 RS-232 port. A pair of Model 1000s supports distances up to 17 mi (27.4 km) at 1200 bps over two 19 AWG (0.9 mm) unconditioned twisted pairs. Operating at data rates up to 19.2 kbps, this cost saving device does not require AC power or batteries to operate. The Model 1000 is DCE/DTE switchable, and is compatible with the Patton Model 1009 (DB-9) and 1015 (DB-15).



The Model 1000S incorporates 600 watts per wire of built-in Silicon Avalanche Diode surge protection.

Rack card, DB-9 (EIA-574), & DB-15 versions are also available!

The dual-port Model 1000RC rack card incorporates two Model 1000 short range modems. You can fit up to 32 SRMs in each 19-in. rack. The Model 1000RC card is available with RJ-11 or RJ-45 rear interface cards.

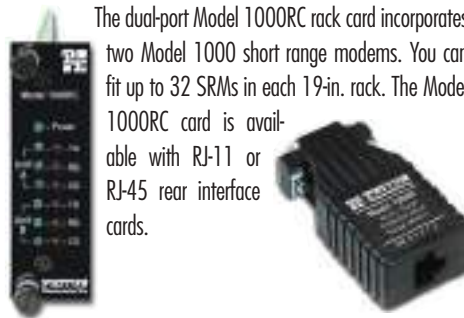

ORDERING INFORMATION

1000M: Male DB-25/terminal block

1000F: Female DB-25/terminal block

1000SM: DB-25, surge protected

1000F RJ11: DB-25/RJ-11 jack

1000M RJ45: DB-25/RJ-45 jack

1009M: Male DB-9/terminal block

1009F: Female DB-9/terminal block

1009SM: DB-9, surge protected

1009F RJ11: DB-9/RJ-11 jack

1009M RJ45: DB-9/RJ-45 jack

FEATURES & BENEFITS

- ✓ Range to 17 miles (27.4 km) on 19 AWG at 1,200 bps
- ✓ Data rates to 19,200 bps
- ✓ External DCE/DTE switch
- ✓ FCC Approved—Part 15 Class A

SPECIFICATIONS

Transmission Format: Async
Data Rate: 0 to 19,200 bps (no strapping)
Control Signal: CTS (Pin 5) turns ON immediately after the terminal raises RTS (Pin 4); DSR (Pin 6) and DCD (Pin 8) turn ON immediately after the terminal raises DTR (Pin 20)
Transmit Line: 4 wire, unconditioned line (2 twisted pair)
Transmit Mode: Full duplex, 4-wire
Transmit Level: 0 dBm

Line Connection: RJ-11 or RJ-45 jack or 5 screw terminal posts and a strain relief
Surge Protection: 600W power dissipation at up to 1 msec
Power: None required, uses ultra low power from EIA data and control signals
Dimensions: 2.20 x 1.75 x 0.75 in. (5.59 x 4.45 x 1.91 cm)

Rack card supports two modems per card.

1000RC11: Dual Rack Card, RJ-45 DTE, RJ-11 line

1000RC45: Dual Rack Card, RJ-45 DTE, RJ-45 line

Note: Other models (including DB-15) are available, call for details.

Transformer Isolated SRMs Guard Against Ground Loops

Models 1010B, 1016 & 1019

The Patton Model 1010B async, 4-wire, transformer isolated short range modem is the best choice for data-only RS-232 connections between buildings. Capable of distances up to 9.5 miles, the Model 1010B's transformer isolation provides immunity from ground loops. 600 watts of built-in surge protection is standard. No AC power or batteries are required for operation.



Rack card, DB-9, DB-15, & RJ-11 versions are also available!

Patton has DB-9, DB-15, RJ11 and rack-card versions! And they're all compatible with the Model 1010B up to 19.2 kbps!



SPECIFICATIONS

Transmission Format: Asynchronous, full duplex
Transmission Line: Two unconditioned twisted pair 19–26 AWG
Interfaces: EIA RS-232, CCITT V.24

Data Rates: Low speed mode: 300 bps–57.6 kbps; High speed mode: 2400 bps–115.2 kbps
Isolation: Minimum 1500V RMS using custom transformers

Control Signals: DSR and DCD follow DTR from the terminal (DTE); CTS follows RTS from the terminal (DTE)
Surge Protection: 600W power dissipation

Connectors: DB-25 male or female on RS-232 side; RJ-11, RJ-45 or terminal block with strain relief on line side
Dimensions: 2.66 x 2.10 x 0.73 in. (6.7 x 5.3 x 1.9 cm)

Power Supply: None required; uses power from EIA data and control signals
Op. Temp.: 32–122°F (0–50°C)
Altitude: 0–15,000 ft (0–4,572 m)

Humidity: 5 to 95% non-condensing
Weight: 2 oz. (56.8 grams)

ORDERING INFORMATION

1010BM: Male DB-25/terminal block

1010BF: Female DB-25/terminal block

1010BF RJ11: with RJ-11 jack

1010BM RJ45: with RJ-45 jack

FEATURES & BENEFITS

- ✓ Immune to ground loops
- ✓ Range to 8 miles (12.9 km) over 2 twisted pairs
- ✓ Asynchronous data rates to 115.2 kbps (Model 1010B only)
- ✓ Surge protection is standard (on Model 1010B only)
- ✓ External DTE/DCE switch
- ✓ Support async, point-to-point, RS-232, communication over two twisted pairs
- ✓ Connects to DB-9 and DB-15 interfaces
- ✓ Compatible with Patton Model 1000
- ✓ Transformer isolated Models 1016 and 1019 for between-building applications

Rack card supports two modems per card

1010RC11: Dual Rack Card, RJ-45 DTE, RJ-11 Line

1010RC45: Dual Rack Card, RJ-45 DTE, RJ-45 Line

Full-duplex RS-232 Over 2-wire Twisted Pair or Coax!

Models 1002 & 1003

The best choice for data-only applications using coax or a single twisted pair.

The **Model 1002** miniature RS-232 short range modem operates full duplex over a single twisted pair or coax cable. Requiring no AC power for operation, the Model 1002 is available with male or female DB-25 connectors, and either strain relief/terminal block, RJ-11, RJ-45 or coax line connections.

The surge-protected Model 1002S provides 600 watts per wire of protection against nearby lightning strikes and other transients.

The **Model 1003** async., 2-wire, carrier sense short-range modem combines the 2-wire capabilities of the Model 1002 with the carrier sense capabilities of the Model 1005. The result is a versatile short haul that allows RS-232 UNIX systems (and similar systems that require carrier sense handshaking) to communicate over coax or a single twisted pair.



The Model 1003 is particularly applicable to environments where coax cable is already installed, or where there is a desire to double the carrying capacity of existing twisted pair lines. Besides its usefulness in UNIX environments (where the host must see carrier to send a logon screen to a terminal), the Model 1003 is also tailored for troubleshooting in systems where the presence or absence of carrier indicates positive or negative line integrity.

The Model 1003S incorporates 600 watts per wire of silicon avalanche diode surge protection on the line side.

FEATURES & BENEFITS

- ✓ Carrier sense handshaking (1003)
- ✓ Operates over coax or a single twisted pair
- ✓ Data rates to 19.2 kbps at 1 mile (2 km)
- ✓ Ideal for UNIX operating environment
- ✓ Available with BNC, RJ-11, RJ-45 or terminal block 2-wire interfaces
- ✓ 600 watts per wire of surge protection

Carrier Sense

Patton's carrier sense short range modems incorporate a special handshaking feature that allows them to "sense" the presence of a carrier signal on the line. This carrier sense feature enables the Model 1003, 1005 and 1006 to perform specialty functions not possible with "data only" SRMs. For example, in UNIX operating environments, the host often needs to see that a terminal is ON before it will send a logon screen. The Model 1003 automatically senses carrier on the line when a terminal is ON, thus fulfilling this requirement.

Coax (BNC) Connections

Available for All 2-Wire Modems

All Model 1002/1003 versions are available with coaxial (BNC) line connections. They're perfect for your installed base of coax cable.



Model 1002 & 1003 Distance Table - Mile (Km)			
Data Rate	Wire Gauge		
	19 (.9mm)	22 (.6mm)	24 (.4mm)
19,200	2.2 (3.5)	1.6 (2.6)	1.2 (1.9)
9,600	3.0 (4.8)	2.1 (3.4)	1.6 (2.6)
4,800	4.3 (6.4)	2.6 (4.2)	1.7 (2.7)
2,400	5.3 (8.5)	2.8 (4.5)	1.8 (2.9)
1,200	5.6 (9.0)	2.8 (4.5)	1.8 (2.9)

ORDERING INFORMATION

1002M: Male DB-25/terminal block

1002F: Female DB-25/terminal block

1002SM: with surge protection

1002F RJ11: with RJ-11 jack

1002M RJ45: with RJ-45 jack

1002M CX: with coax BNC connection

1003M: Male DB-25/terminal block

1003F: Female DB-25/terminal block

1003SM: with surge protection

1003F RJ11: with RJ-11 jack

1003M RJ45: with RJ-45 jack

1003M CX: with coax BNC connection

Example

1003SFRJ45: Female DB-25, surge protected, RJ-45 jack

SPECIFICATIONS

Transmission Format: Asynchronous

Transmit Line: 2 wire unconditioned twisted pair or coaxial cable

Transmit Mode: Full duplex

Transmit Level: 0 dBm

Control Signals: DSR and DCD turn ON immediately after the terminal raises DTR; CTS turns ON immediately after the terminal raises RTS

Range: Up to 1 mile (coax)

Data Rate: 0 to 19,200 bps (no strapping)

Power: None required, uses ultra low power from EIA data and control signals

Dimensions: 2.20 x 1.75 x .75 in. (5.6 x 4.4 x 1.9 cm)

Temperature: 32–122°F (0–50°C)

Humidity: 95% non-condensing

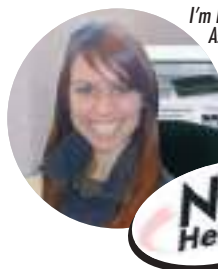

I'm Denise, one of Patton's Sales Associates for Western Europe. Call me at +1 301.975.1000 when you want to purchase Patton products or if you have questions about our products. You can also send e-mail to sales@patton.com.



High-Speed, Multipoint Short-haul Modem

Models 1004A, 1004A Rack Card, & 1008

Still the best choice for high speed multidrop applications

The **Model 1004A** 2/4 wire short range modem (shown at right) gives you up to 50 terminal drops over one (half duplex) twisted pair, and supports async data rates up to 115.2 kbps. Great for same-building applications, the Model 1004A has high/low impedance settings, selectable RTS/CTS delay and a DTE/DCE switch. Plus, 600 watts of surge protection is standard.

The **Model 1008** modem supports all the features of the popular Model 1004A, but with a DB-9 (EIA-574) connector. Plug them directly into closely-spaced serial ports. They are even compatible with stand-alone and rack-mount versions of the 1004A!

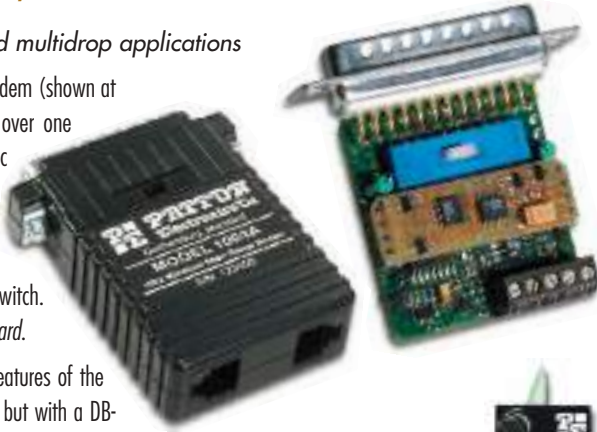

1004A rack card houses two SRMS!

Plug 16 Model 1004A rack cards into a 2U Patton 1001 or 1000 rack system and get 32 short-range modems!



FEATURES & BENEFITS

- ✓ Point-to-point full-duplex operation over 4 wires
- ✓ Multipoint (half-duplex) operation over 2 or 4 wires
- ✓ Multidrop up to 50 terminals
- ✓ Async. data rates to 115.2 kbps
- ✓ Range to 9 mi (14.5 km) on 19 AWG (0.9mm) at 1.2 kbps
- ✓ No AC power or batteries required



See Pg 226

SPECIFICATIONS

Transmission Format: Asynchronous
Data Rate: Up to 115,200 bps
Transmit Line: 2, 4 wire unconditioned twisted pair
Transmit Mode: Full or half duplex
Transmit Level: 0 dbm
Range: Over 9 miles (14.5 km)
Dimensions: 2.66 X 2.10 X 0.73 in. (6.8 X 5.3 X 1.9 cm)
Surge Protection: 600W power dissipation for up to 1 msec
Control Signals: DSR turns "ON" immediately after the terminal raised

DTR: DCD turns on after recognizing the receive signal from the line; CTS turns on 8 mSec after the terminal raises RTS
Power: None required, uses ultra low power from EIA data and control signals
Carrier: The carrier is a strap selected for either continuous operation or controlled by RTS

Typical application



Typical application

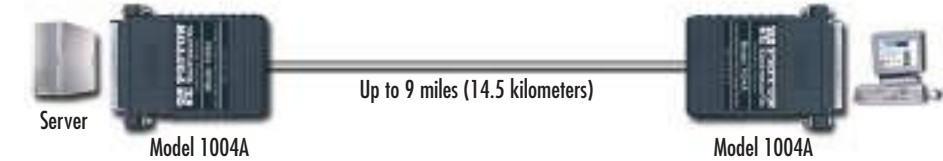

ORDERING INFORMATION

- 1004AM: Male DB-25/terminal block
- 1004AF: Female DB-25/terminal block
- 1004AFRJ11: with RJ-11 jack
- 1004AMRJ45: with RJ-45 jack
- 1004AMDR11: with dual RJ-11
- 1004AMDR45: with dual RJ-45
- 1004ARC11: Dual Rack Card, RJ-45 DTE, RJ-11 line:
- 1004ARC45: Dual Rack Card, RJ-45 DTE, RJ-45 line
- 1008M: Male DB-9/terminal block
- 1008F: Female DB-9/terminal block
- 1008FRJ11: with RJ-11 jack
- 1008MRJ45: with RJ-45 jack
- 1008MDR11: with dual RJ-11
- 1008MDR45: with dual RJ-45

Note: More models are available, check online at www.patton.com or call for details.

Model 1004 & 1008 distance table, in miles (kilometers)

Data Rate (kbps)	Wire Gauge			
	19 (0.9mm)	22 (0.6mm)	24 (0.4mm)	26 (0.2mm)
115.2	3.5 (5.6)	2.6 (4.2)	1.4 (2.3)	0.9 (1.4)
38.4	5.0 (8.0)	2.9 (4.7)	2.2 (3.5)	1.5 (2.4)
9.6	7.1 (11.4)	4.6 (7.4)	3.5 (5.6)	2.8 (4.5)
1.2	9.0 (14.5)	6.5 (10.5)	5.0 (8.0)	3.9 (6.3)

Multidrop Transformer-Isolated Asynchronous Short-Range Modem

Models 1012B & 1012ARC

Perfect for multidrop environments, transformer isolated for between-building applications.



The Model 1012B asynchronous short range modem is ideal for multidrop environments or for applications requiring hardware control signals.

Attaining DC isolation through custom-designed ferrite core transformers, the Model 1012B operates effectively between buildings. In a point-to-point application, the Model 1012B will operate full or half duplex up to 5.2 mi (8.4 km). Supporting data rates to 38.4 kbps, the Model 1012B

requires no AC power for operation. 600 watts per wire of silicon avalanche diode surge protection on the line side is standard.

The Model 1012ARC is a rack-mountable version of the Model 1012A. Model 1012ARC plugs into Patton's 2U high 19 inch chassis and provides you with two short haul modems per card. And, they are available with RJ-11 or RJ-45 line connectors.



Model 1012 distance table, in miles (kilometers)			
Data Rate	Wire Gauge		
	19 (0.9mm)	22 (0.6mm)	24 (0.4mm)
1,200 to 38,400	5.2 (8.4)	2.8 (4.5)	2.0 (3.2)

SPECIFICATIONS

Trans. Format: Asynchronous
Transmit Line: 4 wire unconditioned twisted pair
Transmit Mode: Full or half duplex
Transmit Level: -6 dBm

Control Signals: DSR turns "ON" immediately after the terminal raises DTR; DCD turns "ON" after recognizing the receive signal from the line; carrier is continuously "ON" or controlled by RTS; CTS turns "ON" 40 mSec after the terminal raises RTS

Surge Protection: 600W power dissipation at 1 mS
Data Rate: 0 to 38.4 kbps (no strapping)
Range: Up to 6 miles (9.7km), depending on wire gauge

Power: None required
Dimensions: 2.66" x 2.10" x 0.73" (6.8 x 5.3 x 1.9 cm)

Synchronous/Asynchronous Short-Range Modem

Model 1040

Sync/async in a compact SRM.

The Model 1040 self-powered miniature short range modem packs the features of Patton's Model 1080 into a package that requires no AC power. Operating asynchronously or synchronously, the Model 1040 supports data rates to 38.4 kbps and distances to 12 miles (19.3 km). The Model 1040 will operate over 2 or 4 wires, in point-to-point or multipoint environments. In synchronous mode, the Model 1040 supports internal, external or receive loopback clocking.

The Model 1040 incorporates two V.54 and two V.52 BER test modes, which can be activated via the RS-232 interface. Built-in LEDs let you monitor test mode operation.

Additional peace of mind comes from knowing that the Model 1040 has both transformer isolation and surge protection to guard against data loss. The Model 1040 is designed to plug directly into the RS-232 interface.

Twisted pair wire is connected using RJ-11, RJ-45 or terminal blocks.



SPECIFICATIONS

Range: 10 miles (16.1Km) @ 1200 bps on 22 AWG 2-pair wire
Data Rates: Sync & Async: 1.2, 1.8, 2.4, 3.6, 4.8, 7.2, 9.6, 14.4, 19.2, 28.8, 38.4, externally switch selection
Operation: Point-to-point or multipoint
Transmit Mode: 2-wire/half duplex, 4-wire/full duplex

Connectors: DB-25 M, F (RS-232), RJ-11 jack and terminal block
Diagnostics: 100% V.54 compliant and 100% V.52 compliant BER tests
LED Indicators: BERT indicator, Loop/Test indicator
Interface: EIA RS-232, CCITT V.2

Carrier: Constantly ON or controlled by RTS
RTS/CTS Delay: Externally strap selected to 0.7, or 50 mS
Receive Clock: Derived from receive signal
Isolation: Transformer, 1500V RMS

Transmit Clock: Internal, external or looped back from recovered signal
Surge Protection: 600 watts power dissipation for up to 1 msec
Dimensions: 2.6 x .73 x 2.1 in. (6.6 x 1.9 x 5.3 cm)

FEATURES & BENEFITS

- ✓ Data rates to 38.4 kbps
- ✓ Supports 15 drops in a multipoint polling environment
- ✓ Transmits and receives one control signal each way
- ✓ Transformer isolated and surge protected
- ✓ External DCE/DTE switch

ORDERING INFORMATION

1012BFR11TB: Female DB-25; RJ-11 & terminal block

1012BMR11TB: Male DB-25; RJ-11 & terminal block

1012BFR45TB: Female DB-25; RJ-45 & terminal block

1012BMR45TB: Male DB-25; RJ-45 & terminal block

1012ARC11: Dual Rack Card, RJ-45 DTE, RJ-11 Line

1012ARC45: Dual Rack Card, RJ-45 DTE, RJ-45 Line

Note: More models are available, call for details.

FEATURES & BENEFITS

- ✓ Async or sync operation
- ✓ RS-232 data rates to 38.4 kbps
- ✓ Distances to 12 mi (19.3 km)
- ✓ Point-to-point or multipoint
- ✓ 2-wire half duplex, 4-wire full duplex
- ✓ V.54 and V.52 test modes
- ✓ Internal, external or receive recover clocking (sync. mode)
- ✓ Transformer isolation and surge protection

ORDERING INFORMATION

1040M: Male DB-25/terminal block

1040F: Female DB-25/terminal block

1040SM: with surge protection

1040F RJ11: with RJ-11 jack

1040M RJ45: with RJ-45 jack

Note: More models are available, call for details.

Self-Powered, Synchronous, Short-Range Modems

Models 1020, 1025, & 1030

The Lowest Cost Solution for Sync Applications

The Models 1020, 1025, and 1030 are our most basic self-powered, synchronous short-range modems. Supporting data rates from 1.2 to 19.2 kbps, these units extend RS-232 communication up to 11 mi (17.7 km) at 1200 bps over two 19 AWG (0.9mm) unconditioned twisted pairs. The Model 1020 provides internal clock only, while the Model 1025 supports internal external and receive recover clock. The

Model 1030 has all these features *plus* it passes a control signal in each direction—making it ideal for synchronous multipoint applications. All models have transformer isolation guarding against ground loops in between-building applications.



FEATURES & BENEFITS

- ✓ Selectable sync data rates from 1,200 to 19,200 bps
- ✓ Internal, external or receive recover clock (Model 1020, internal clock only)
- ✓ Ideal for multipoint configurations (Model 1030 versions only)
- ✓ Transformer isolation helps prevent ground loops
- ✓ Optional surge protection (Models 1020S, 1025S, and 1030S)
- ✓ FCC approved—Part 15 Class A
- ✓ No AC power required



Dual RJ-11 or RJ-45 versions (1030) for easy daisy-chain installation!



Model 1020/1025/1030 distance table, in miles (kilometers)			
Data Rate	Wire Gauge		
	19 (0.9mm)	22 (0.6mm)	24 (0.4mm)
19,200	7.5 (12.1)	3.5 (5.6)	2.5 (4.0)
9,600	10.0 (16)	3.6 (5.6)	2.5 (4.0)
4,800	10.0 (16)	7.0 (11.3)	4.0 (6.4)
2,400	10.0 (16)	8.5 (13.7)	5.0 (8.0)
1,200	11.0 (17.6)	8.5 (13.7)	6.0 (9.7)

I'm Natalie, Patton's Inside Sales Manager, US & Canada. Call me at +1 301.975.1000 when you want to purchase Patton products or if you have questions about our products. You can also send e-mail to sales@patton.com.

SPECIFICATIONS

Transmission Format: Synchronous
Clocking: Model 1020—Internal clock; Model 1025/30—internal, external, or receive recover clock (switch selectable)
Transmit Mode: Full duplex
Transmit Level: -6 dBm
Control Signals: CTS turns "ON" 8 mS after the terminal raises RTS; DSR and DCD are constantly "ON"

Surge Protection: 600W power dissipation
Data Rate: 1200 to 19,200 bps including 7.2 & 14.4
Power: None required; uses ultra low power from EIA data and control signals
Range: Up to 11 miles (17.7 km)
Dimensions: 2.66 x 2.10 x 0.73 in. (6.8 x 5.3 x 1.9 cm)

ORDERING INFORMATION

- 1020M: Male DB-25/terminal block
- 1020F: Female DB-25/terminal block
- 1020SM: with surge protection
- 1020F RJ11: with RJ-11 jack
- 1020M RJ45: with RJ-45 jack
- 1025M: Male DB-25/terminal block
- 1025F: Female DB-25/terminal block
- 1025SM: with surge protection

- 1025F RJ11: with RJ-11 jack
- 1025M RJ45: with RJ-45 jack
- 1030M: Male DB-25/terminal block
- 1030F: Female DB-25/terminal block
- 1030SM: with surge protection
- 1030F RJ11: with RJ-11 jack
- 1030M RJ45: with RJ-45 jack

Note: More models are available, call for details.

visit us online
www.patton.com

FAST Delivery From Your AUTHORIZED DISTRIBUTOR!



High Speed, Synchronous Short-Range Modem

Models 1035

Great for Low Cost LAN-to-LAN Campus Connectivity

The Model 1035 high speed short range modem supports synchronous data rates of 32, 56 and 64 kbps, and distances up to 6 mi (9.7 km) (19 AWG at 32 kbps) over two unconditioned twisted pair. Transmit clock options are internal, external and receive recover clock.

Powered from a 7.5V wall-mount transformer, the Model 1035 incorporates two V.54 test modes and a V.52 BER test pattern generator/detector. Five easy-to-read LED indicators monitor power, transmit data, carrier detect, test mode and test pattern. For protection against ground loops and transient surges, the Model 1035 incorporates both isolation transformers and silicon

avalanche diode surge suppressors. The Model 1035 is available in an RS-232/V.24 version and a CCITT V.35/RS-530 version, both supported on a DB-25 connector. Twisted-pair connection are made using RJ-11 or RJ-45.



SPECIFICATIONS

Transmission Format:

Synchronous

Transmission Line: Unconditioned twisted pair 19–26 AWG (0.7mm–0.4)

Clocking: Internal, external or receive recover

Interfaces: EA RS-232/ V.24 or CCITT V.35

Data Rates: 32, 56 and 64 kbps (switch selectable)

Isolation: Minimum 1500 V RMS using isolation transformers

Surge Protection: 600W power dissipation for up to 1 msec

Control Signals: "Constantly on" or "Controlled by RTS"

RTS/CTS Delay: No delay, 7ms, 53ms

Power Supply: 7.5V DC wall mount transformer

Distance: To 6 mi (9.7 km)

Temperature Range: 32–122°F (0–50°C)

Dimensions: 3.6 x 2.1 x 0.8 in. (9.0 x 5.3 x 2.0 cm)

Self-Powered Line Extenders

Model 1225 ParaLink™

Extend parallel communication to 2,000 feet (610 m) over a single twisted pair

The Model 1225 ParaLink answers a common office complaint: "Why can't we move our printer further away?" Using surface mount technology, the interface-powered ParaLink converts parallel signals to serial and transmits them up to 2,000 feet (610 m) before converting them back to parallel. This overcomes the inherent distance limitations of parallel communication! What's more, the ParaLink transmits over a single pair of wires—no more bulky 25 or 36-conductor cables. Because the ParaLink lets you choose between BUSY and ACKNOWLEDGE handshaking modes, it is compatible with most parallel printers and sharing devices on the market.



SPECIFICATIONS

Interface: Centronics/IBM parallel (DB-25)

Data Rate: 5 kbps (parallel)/40 kbps (serial)

Range: Up to 2,000 feet (610 m)

Transmit Line: One unconditioned twisted pair (2 wires)

Transmit Mode: Half duplex

Line Connection: RJ-11 or RJ-45 jack or 2 position terminal post and a strain relief

Interface Signals: Data bits 0-7, ground, busy or acknowledge (external switch selectable)

Power Supply: Interface powered, no AC power or batteries required

Dimensions: 2.67L x 2.10W x 0.74H in. (6.7L x 5.3W x 1.88H cm)

FEATURES & BENEFITS

- ✓ Sync Data Rates of 32, 56 and 64 kbps
- ✓ Distances up to 6 Miles (9.7Km)
- ✓ V.54 and V.52 Diagnostic Modes
- ✓ RS-232 or V.35 (RS-530) Versions
- ✓ Internal, External or Receive Recover Clocking Options
- ✓ Transformer Isolation and Surge Protection

ORDERING INFORMATION

RS-232/V.24 Versions

1035/24M RJ-11: Male DB-25/RJ-11 jack

1035/24F RJ-11: Female DB-25/RJ-11 jack

1035/24M RJ-45: Male DB-25/RJ-45 jack

1035/24F RJ-45: Female DB-25/RJ-45 jack

CCITT V.35 Versions

1035/35M RJ-11: Male DB-25/RJ-11 jack

1035/35F RJ-11: Female DB-25/RJ-11 jack

1035/35M RJ-45: Male DB-25/RJ-45 jack

1035/35F RJ-45: Female DB-25/RJ-45 jack

Note: More models are available, call for details.

FEATURES & BENEFITS

- ✓ Interface Powered—No AC Needed
- ✓ Switchable ACK/BUSY handshaking enhances printer compatibility
- ✓ Accommodates "low power" printer interfaces
- ✓ DB-25 or Centronics connectors
- ✓ RJ-11, RJ-45 or terminal block twisted pair connection

ORDERING INFORMATION

Terminal block version

1225TM: Transmitter, male DB-25

1225CRM: Centronics receiver, male

1225RM: Receiver, male DB-25

1225RF: Receiver, female DB-25

RJ-11 version

1225TMRJ11: Transmitter, male DB-25

1225CRM: Centronics receiver, male

1225RM: Receiver, male DB-25

1225RF: Receiver, female DB-25

Note: More models are available, call for details.

High Speed, Short-Range Modem (RS-232 & RS-530)

Model 1045

Great for LAN-to-LAN or Tail Circuit Applications in Sync or Async Environments

The Model 1045 KiloModem™ is Patton's most capable plug-in short haul modem to date. The Model 1045 supports both async and sync communication at switch selectable data rates of 32, 56 and 64 kbps. Deriving power from an external AC transformer, the Model 1045 supports distances up to 6 miles/9.7km (19 AWG @ 32 kbps) over two unconditioned twisted pair. Synchronous transmit clock options are internal, external and receive recover



SPECIFICATIONS

Transmission line: 19–26 AWG (0.9–0.4mm) private unloaded twisted pair or unconditioned telephone company local area data (LAD) channels; (see AT&T specification 41028)
Data Rates: Async. 32, 56 and 64 kbps. Sync. 32, 56 and 64 kbps.
Carrier: Always on or controlled by RTS (point-to-point or multipoint operation)
Interface: EIA RS-232 or CCITT V.35

RTS/CTS delay: Switch-selected to 0, 7, or 53 mS
Diagnostics: 100% compliance with V.54 test modes (switch-selectable)
BERT: 100% compliance with V.52 including 511 & 511E bit pattern generation (switch-selectable)
Receive clock: Derived from receive signal

Transmit clock: Internal, external (from pin 24) or receive recover
Indicators: Status LEDs for TD, DCD, PWR and Test
Isolation: 1500V RMS via isolation transformers
Power supply: External wallmount transformer available with 120 or 230V
Surge suppression: 600W power dissipation

Dimensions: 3.55 x 2.1 x 78 in. (9.0 x 5.3 x 2 cm)

Model 1045 distance table, in miles (kilometers)			
Data Rate	Wire Gauge		
	19 (0.9mm)	24 (0.5mm)	24 (0.4mm)
64,000	5.3 (8.5)	4.2 (6.7)	2.5 (4.0)
56,000	6.8 (10.9)	4.2 (6.7)	2.6 (4.2)
32,000	9.1 (14.6)	4.7 (7.5)	3.0 (4.8)

Async Short Range Modem with Extra Controls

Model 1018

The Perfect Solution for Inexpensive SLIP/PPP Campus Internet Connections

The Model 1018 async short range modem is able to pass two discrete sets of handshaking signals: DTR & DCD are used to control the point-to-point session, while RTS & CTS are used for flow control. This capability—combined with the Model 1018's ability to support RS-232 data rates up to 57.6 kbps over two twisted pair—makes the



Model 1018 perfect for inexpensive campus Internet links. Just use a plug-in Model 1018 at each remote computer, a rack of Model 1018RC cards at the central site, and connect them with 2-pair copper wire at up to 2.4 miles (3.9 km)!

SPECIFICATIONS

DTE transmission format: Async
Transmission line: Unconditioned twisted pair 19–26 AWG (0.4mm)
Link Clocking: Internal
Distance: 2.4 miles (3.9km) at all data rates
Interfaces: EIA RS-232/CCITT V.24

DTE Data Rates: 1.2, 2.4, 4.8, 9.6, 19.2, 28.8, 38.4 and 57.6 kbps (switch selectable)
Control Signals: DTR/DCD (Session Control), RTS/CTS (Flow Control)
Carrier: "Constantly on" or "Controlled by DTR"

Surge Protection: 600W power dissipation for up to 1 msec
Isolation: Minimum 1500 V RMS using isolation transformers
Connectors: DB-25 female or male on RS-232 side; RJ-11 or RJ-45 on line side

Power: 7.5V DC wall mount transformer
Op. Temp: 32–122°F (0–50°C)
Dimensions: 3.55 x 2.1 x .80 in. (9.0 x 5.3 x 2.0 cm)

FEATURES & BENEFITS

- ✓ Async or sync operation
- ✓ Data rates of 32, 56 & 64 kbps
- ✓ Distances to 6 miles (9.7 km)
- ✓ V.54 loopback test modes
- ✓ Built-In V.52 BER generator/detector
- ✓ Internal, external or receive recover clocking in sync mode
- ✓ Transformer isolation and surge protection

ORDERING INFORMATION

RS-232/V.24 Versions

1045/24M: RJ-11 Male DB-25/RJ-11 jack

1045/24F RJ-11: Female DB-25/RJ-11 jack

1045/24M RJ-45: Male DB-25/RJ-45 jack

1045/24F RJ-45: Female DB-25/RJ-45 jack

CCITT V.35 Versions

1045/35M RJ-11: Male DB-25/RJ-11 jack

1045/35F RJ-11: Female DB-25/RJ-11 jack

1045/35M RJ-45: Male DB-25/RJ-45 jack

1045/35F RJ-45: Female DB-25/RJ-45 jack

Async./Sync. Rack Card

1045RC11: DB-25 DTE & RJ-11 Line

1045RC45: DB-25 DTE & RJ-45 Line

1045RC4511: RJ-45 DTE & RJ-11 Line

1045RC4545: RJ-45 DTE & RJ-45 Line

Note: More models are available, call for details.

FEATURES & BENEFITS

- ✓ Async data rates from 1.2 to 57.6 kbps
- ✓ External AC power supply
- ✓ Transformer isolated and surge protected
- ✓ Passes "Session Control" (DTR/DCD) and "Flow Control" (RTS/CTS) handshaking signals

ORDERING INFORMATION

1018M RJ11: Male DB-25/RJ-11 jack

1018F RJ11: Female DB-25/RJ-11 jack

1018M RJ45: Male DB-25/RJ-45 jack

1018F RJ45: Female DB-25/RJ-45 jack

1018RC11: Female DB-25/RJ-11 jack

1018RC45: Female DB-25/RJ-45 jack

Note: More models are available, call for details.

See
Pg 226**AC Powered, Asynchronous SRM (up to 38.4 kbps)****Model 1050**

The Key Features You Need at a Price that Leaves a Small Footprint on Your Budget!

The Model 1050 AC Powered Asynchronous Short Range Modem is to our AC powered short haul line what the Model 1000 is to our interface powered line—a basic short haul at a great price! And the Model 1050 has the key features you need: optical isolation, a local loopback test mode, LED indicators and a DCE/DTE switch.

The Model 1050 supports asynchronous RS-232 data rates to 38.4 kbps, and supports distances up to 14 miles (22.5 km). Housed in an ultra-compact enclosure, the Model 1050 provides both an external RJ-11 jack and internal terminal block for line connection. On the RS-232 side, a female DB-25 is



standard. The Model 1050 is designed for point-to-point applications, with one unit on each end of the line. However, the Model 1050 is also compatible with the Patton Models 1060 and 1226 short hauls.

SPECIFICATIONS

Transmission Line: 19 to 26 AWG twisted pair
Range: 4 Miles (6.4 Km) on two 24 AWG pairs

Serial Interface: EIA RS-232 /CCITT V24, DB-25 female
Line Connection: RJ-11 and internal terminal block w/ strain relief
Data Rates: 1.2 to 38.4 kbps

Diagnostics: Local Loopback
Indicators: Tri-state LEDs for RD, TD and Test
Power: External wallmount transformer available with 115 or 240V

Optical Isolation: 2500V RMS on DCE Interface
Dimensions: 1.58H x 4.16W x 3.75D in. (10.6H x 4.1W x 8.8D cm)

AC Powered, Asynchronous SRM (up to 115.2 kbps)**Model 1060**

The ideal choice for async UTP or STP applications!

The Model 1060 AC Powered, Asynchronous Short-Range Modem is Patton's most sophisticated async twisted-pair short haul. The Model 1060 adapts to a wide range of applications, while providing the resources to deal with less-than-optimum conditions. Supporting hardware or software flow control, the Model 1060 operates in point-to-point and multipoint. The Model 1060 handles data rates to 115.2 kbps, and supports distances to 14 miles (22.5 km) over two twisted pair.



Because the line side is optically isolated and surge protected, you can install the Model 1060 in environments where EMR or ground loops would normally prohibit twisted pair data communications. Assignable control signals and DCE/DTE switchability complete the picture.

Data Rate	Wire Gauge		
	19 (0.9mm)	24 (0.5 mm)	24 (0.4mm)
115.200*	1.8 (2.9)	0.75 (1.2)	0.38 (0.6)
57,000	2.5 (4.0)	1.3 (2.1)	0.95 (1.5)
38,400	3.7 (6.0)	1.5 (2.4)	1.33 (2.1)
19,200	4.17 (6.7)	1.9 (3.1)	1.42 (2.3)
9,600	5.41 (8.7)	2.6 (4.2)	2.08 (3.3)
4,800	7.05 (11.3)	3.8 (6.1)	2.84 (4.6)
2,400	11.5 (18.5)	7.0 (11.3)	4.83 (7.8)
1,200	14.0 (22.5)	8.5 (13.7)	5.68 (9.1)

* Model 1060 only.

SPECIFICATIONS

Transmission Format: Asynchronous
Interface: RS-232 (CCITT V24) DB-25 female
Data Rate: 0 to 115.20 kbps
Transmission Line: 4-wire, unconditioned via RJ-11 or terminal blocks (RJ-45 optional)

Diagnostics: Loop 3 and 4, local and remote analog loopback
Indicators: Tri-state indicators for Transmit Data, Receive Data, Control In and Control Out
Power: Wall-mount, 12VAC, 200mA
Dimensions: 4.17W x 1.52H x 5.0L in. (10.6W x 3.9H x 12.7L cm)

FEATURES & BENEFITS

- ✓ Asynchronous RS-232 operation over two twisted pair
- ✓ Data rates to 38,400 bps
- ✓ Optical isolation
- ✓ Loopback test
- ✓ Distances to 14 miles (22.5 km)
- ✓ DCE/DTE switchable
- ✓ Ultra-compact enclosure

ORDERING INFORMATION

1050-120: Async., Powered, Standalone: Short Haul Modem (120V)
1050-230: Async., Powered, Standalone: Short Haul Modem (230V)

Note: More models are available, call for details.

FEATURES & BENEFITS

- ✓ Asynchronous RS-232 operation over two twisted-pair
- ✓ Data rates to 115.2 kbps
- ✓ Optical isolation
- ✓ Loopback test
- ✓ Distances to 14 miles (22.5 km)
- ✓ DCE/DTE switchable
- ✓ Ultra-compact enclosure

ORDERING INFORMATION

1060: Async., Powered, Standalone: Short Haul Modem (120V)
1060-220: Async., Powered, Standalone: Short Haul Modem (230V)
1060RC11: Async., Powered, Rack Card: w/ DB25 DTE & RJ-11 Line
1060RC45: Async., Powered, Rack Card: w/ DB25 DTE & RJ-45 Line
1060RC4511: Async., Powered, Rack Card: RJ-45 DTE, RJ-11 Line
1060RC4545: Async., Powered, Rack Card: w/ RJ-45 DTE & RJ-45 Line

Note: More models are available, call for details.

AC Powered SRM, Synchronous & Opto-Isolated

Model 1070

Ensure data integrity with loopback tests, status indicators and opto-isolation

The Model 1070 AC Powered, Synchronous Short Range Modem is designed with three RS-232 communications environments in mind: low power, high noise, and mission critical.

A low power environment is one where the RS-232 interface does not provide the necessary signal voltages to operate a self-powered short haul. The Model 1070 handles this problem by deriving power via external AC transformer—either 120 or 230 volts.

A high noise environment is one where transmission is impeded by unwanted energy on the twisted pair line. The Model 1070 counters this problem in several ways: Optical isolation eliminates ground loop currents in between-building applications. Silicon Avalanche Diode surge protection takes out data line transients from lightning strikes and other sources of EMR. Finally, a custom VLSI chip inside the Model 1070 filters out noise separately at each data rate.



A mission critical environment is one where data integrity is essential. The user needs to ensure that the modem connection is operating properly and that the data is being passed. The Model 1070 ensures data integrity, not only by using surge protection and optical isolation, but by providing local and remote loopback tests and front panel LED signal monitors.

The Model 1070 has convenience features that make it the best choice for many other sync. applications: The 1070 handles both hardware and software flow control requirements, has both a terminal block and RJ-11 jack for twisted pair hook up, and provides external access for all configuration switches.

Model 1070 Distance Table - Mile (Km)			
Data Rate	Wire Gauge (AWG/mm)		
	19 (.9mm)	22 (.6mm)	24 (.4mm)
19,200	2.5 (4.0)	2.1 (3.4)	1.3 (2.1)
9,600	3.7 (6.0)	2.3 (3.7)	1.7 (2.7)
4,800	4.9 (7.9)	4.9 (7.9)	2.5 (4.0)
2,400	5.8 (9.3)	5.8 (9.3)	4.6 (7.4)
1,200	8.3 (13.4)	8.3 (13.4)	6.8 (10.9)

FEATURES & BENEFITS

- ✓ Data Rates from 1.2 to 19.2 kbps
- ✓ Point-to-Point or Multipoint Operation
- ✓ Optically Isolated & Surge Protected
- ✓ Internal or External Clocking



See Pg 226

ORDERING INFORMATION

- 1070: Sync., Powered, Standalone: Short Haul Modem (120V)
- 1070-220: Sync., Powered, Standalone: Short Haul Modem (230V)
- 1070RC11: Sync., Rack Card: with DB-25 DTE & RJ-11 Line
- 1070RC45: Sync., Rack Card: with DB-25 DTE & RJ-45 Line
- 1070RC4511: Sync., Rack Card: with RJ-45 DTE & RJ-11 Line
- 1070RC4545: Sync., Rack Card: with RJ-45 DTE & RJ-45 Line

Note: More models are available, call for details.

AC Powered X.21 SRM, Synchronous & Opto-Isolated

Model 1075

Our most cost effective way to extend sync X.21 connections!

The Model 1075 KiloModem II™ X.21 short range modem allows point-to-point connection of synchronous X.21 devices at distances to 7.1 miles (11.4 km) (see distance table below). Supporting switch selectable data rates of 32, 56 and 64 kbps, the Model 1075 provides internal, external or receive recovered clocking options. Diagnostics include V.54 and V.52 compliant tests. Both transformer isolation and surge protection are built into the Model 1075 as well.



FEATURES & BENEFITS

- ✓ Synchronous data rates of 32, 56 and 64 kbps
- ✓ Distances to 7.1 miles over two twisted pairs
- ✓ Built-in isolation and surge protection
- ✓ V.54 and V.52 Diagnostics

Model 1075 Distance Table - Mile (Km)				
Data Rate (kbps)	Wire Gauge (AWG/mm)			
	19 (.9mm)	22 (.6mm)	24 (.5mm)	26 (.4mm)
64	3.5 (5.6)	2.6 (4.2)	1.4 (5.6)	0.9 (1.4)
56	5.0 (8.0)	2.9 (4.7)	2.2 (3.5)	1.5 (2.4)
32	7.1 (11.4)	4.6 (7.4)	3.5 (5.6)	2.8 (4.5)

SPECIFICATIONS

Approvals: CE European Directives DTE/DCE I/F: X.21 DB15F DCE or DTE, EIA RS-422 Compliant

Compatibility: 1035, 1045, 1075, 1080A, 1090 series units

Transmission Format: Synchronous Transmission Unconditioned twisted pair 19—26 AWG

Line Interface: Externally accessible RJ-45 (RJ-11 Optional)

Clock: Internal, External and Network (Receive Recover)

Distance: Up to 7.1 miles (11.4 km)

Interfaces: CCITT/ITU X.21

Data Rates: 32, 56 and 64 kbps (switch selectable)

Isolation: 1500V RMS via isolation transformers

Surge Protection: IEC-801-S, Level 2, 1kV Carrier Control Constantly on

or Controlled by "Control" from DTE device (DCE mode) or "Indication" from DCE device (DTE mode)

Connectors: DB-15 female (X.21); RJ-45 on line side*

Power: 9V DC transformer, 200mA

Temperature Range: 32—140°F (0—60°C)

Altitude: 0-15,000 feet (0-4,572 meters)

Humidity: 5 to 95% non-condensing

Dimensions: 1.54H x 4.1W x 3.7D in. (3.9H x 10.4W x 9.4D cm)

Power Options: 120 VAC 50/60Hz, external transformer; 230 VAC 50/60Hz, external transformer

Weight: 2.5 lbs. (1.1 kg)

ORDERING INFORMATION

1075/D/120: Synchronous X.21 Short Range: Modem, DB-15 Female, RJ-45* (120 VAC wall mount power)

1075/D/230: Synchronous X.21 Short Range: Modem, DB-15 Female, RJ-45* (230 VAC power, external)

* RJ-11 available on request

Note: More models are available, call for details.

visit us online
www.patton.com

FAST Delivery From Your AUTHORIZED DISTRIBUTOR!

PATTON
Electronics Co.

Universal Short Range Modem

Models 1080A & 1080A-64

You can use the Model 1080A in just about any RS-232 UTP or STP application

The Model 1080A AC Powered, Universal Short Range Modem is the mainstay of our RS-232 short haul line, and it is now better than ever! Recent improvements in the Model 1080A include increased distances (up to 17 miles (27.4 km) on one or two unconditioned twisted pair), support for higher data rates (up to 57.6 kbps), and the addition of a built-in V.52 BER test pattern generator. Of course, the Model 1080A retains all the features that you have come to expect: asynchronous or synchronous RS-232 operation, half duplex communication over two wires or a choice of half or full duplex communication over four wires, support for point-to-point or multipoint applications, and fully compliant V.54 test modes (local analog loop and remote digital loop).

New automated features include equalization, gain control and noise filtering (a separate filter for each data rate is built into a custom VLSI chip). To combat the many nemeses of clear data transmission, the Model 1080A includes surge protection (guards against transients), transformer isolation (eliminates ground looping) and a new anti-streaming timer (stops data streaming).



The Model 1080A packs a lot of convenience into a tiny box: front panel LEDs give a clear picture of link status; V.54 tests can be activated remotely or via the front panel; and the unit can be externally configured (no need to open the case). Best of all, the Model 1080A standalone is fully compatible with the Model 1080A rack card and the new self-powered Model 1040 short haul.

Model 1080ARC rack cards are also available!

The Model 1080ARC fits in Patton's 2U high rack chassis and 2/4/8 ClusterBoxes™. Four plug-in rear interface cards are available.



See Pg 226



Model 1080A distance table, in miles (kilometers)			
Data Rate (kbps)	Wire Gauge		
	19 (0.9mm)	22 (0.6 mm)	24 (0.4mm)
57,600	12.0 (19.3)	7.0 (11.2)	5.3 (8.5)
38,400	13.0 (20.9)	7.5 (12.1)	6.2 (10)
19,200	16.0 (25.8)	8.5 (13.7)	7.0 (11.3)
9,600	18.5 (29.8)	13.0 (20.9)	10.4 (16.7)
4,800	19.5 (31.4)	14.0 (22.5)	11.3 (18.2)
2,400	20.5 (33.0)	15.0 (24.2)	11.6 (18.7)
1,200	20.0 (32.2)	15.0 (24.2)	11.4 (18.4)

Model 1080A-64 distance table, in miles (kilometers)			
Data Rate (kbps)	Wire Gauge, in AWG (mm)		
	19 (0.9mm)	22 (0.6 mm)	24 (0.4mm)
64,000	11.0 (17.7)	6.5 (10.5)	5.0 (8.1)
32,000	13.5 (21.7)	7.5 (12.1)	6.4 (10.3)
16,000	16.5 (26.6)	10.0 (16.1)	8.4 (13.5)

SPECIFICATIONS

Range: 17.5 miles at 1200 bps, 19 AWG 2-pair wire

Data Rates: Sync or Async: 1.2, 1.8, 2.4, 3.6, 4.8, 7.2, 9.6, 14.4, 19.2, 28.8, 38.4, and 57.6 kbps, externally switch selected

Operation: Point-to-point or multipoint

Transmit Mode: Synchronous or asynchronous, 2-W/half duplex, 4-W/half or full duplex

Interface: EIA RS-232, CCITT V.24

Diagnostics: V.54 compliant local analog loopback & remote digital loopback; V.52 compliant 511 and 511E test pattern generator

LED Indicators: TD, RD, RTS, DCD, Power, Test

Carrier: Constantly ON or Controlled by RTS

RTS/CTS Delay: Strap selected: 0.0, 8.5 or 50 mS

Isolation: Transformer, 1500V RMS

Connectors: DB-25 female (RS-232), RJ-45 jack and terminal block (RJ-11 optional)

Transmit Clock: Internal, external or receive recover

Surge Protection: SAD, 600W power dissipation

Power Supply: External transformer, 120V or 230V

Dimensions: 4.17W x 1.52H x 5.0L in. (10.6W x 3.9H x 12.7L cm)

FEATURES & BENEFITS

- ✓ Async or sync operation
- ✓ 4-wire half or full-duplex/2-wire half-duplex only
- ✓ RS-232 data rates to 57.6 kbps
- ✓ Distances over 17 miles (27.4 km)
- ✓ Point-to-point or multipoint
- ✓ V.54 and V.52 test modes
- ✓ Automatic equalization/gain control
- ✓ Internal, external, or received recover clocking in sync. mode
- ✓ Custom VLSI noise filter chip
- ✓ Transformer isolation/surge protection
- ✓ Anti-streaming timer
- ✓ Fully compatible with the Model 1040 synchronous/asynchronous short-range modem



I'm Maria, one of Patton's Sales Coordinators. If you have questions about our products, call +1 301.975.1000 or send e-mail to sales@patton.com.



ORDERING INFORMATION

1080: Async./Sync. Standalone Short Haul Modem (120V)

1080A-220: Async./Sync. Standalone Short Haul Modem (230V)

1080A-64-120: Async./Sync. 64k Standalone Short Haul Modem (120V)

1080A-64-230: Async./Sync. 64k Standalone Short Haul Modem (230V)

1080ARC11: Async./Sync. Rack Card with DB-25 DTE & RJ-11 Line

1080ARC45: Async./Sync. Rack Card with DB-25 DTE & RJ-45 Line

1080ARC4511: Async./Sync. Rack Card with RJ-45 DTE & RJ-11 Line

1080ARC4545: Async./Sync. Rack Card with RJ-45 DTE & RJ-45 Line

Note: More models are available, call for details.



Industrial Short-Range Modem for Outdoor Use

Model 1065

This environmentally enhanced, async. and sync., baseband modem provides reliable data communications—even in the harshest of environments.

The Model 1065 comes housed in a ruggedized chassis that includes extended-temperature components and protective treatments that make it ideal for use in harsh industrial settings such as railways, refineries, and manufacturing facilities.

With built-in transformer isolation and surge protection, the 1065 supports data rates to 64 kbps at distances over 12 miles (19.2 km)

For centralized data centers, users can cluster up to 14 1065RC modem rack cards in the Model 1001 rack chassis. The Model 1001 rack system includes redundant power supply options that protect against power-related failures, providing fault-tolerant operation.

Typical applications for the Model 1065 include using it in automatic train control systems where the modems relay data between central control sites and track-side control/monitoring equipment. This application requires equipment that is reli-



able in all weather conditions, because the electronic interlocking systems must continuously control wayside equipment such as signals, point machines, derailleurs, etc., in such a manner that trains run on time, and passengers and cargo travel safely to their destinations.

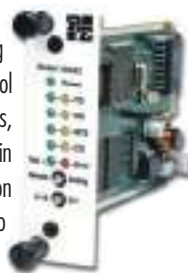

FEATURES & BENEFITS

- ✓ Environmentally ruggedized sync./async. baseband modem
- ✓ V.14 async. to sync. conversion, standard and extended rates.
- ✓ Character lengths of 8, 9, 10, and 11 bits, start and stop bits included
- ✓ Supports point-to-point or multi-point operation
- ✓ Supports data rates up to 64 kbps at distances over 12 miles (19.2 km)
- ✓ Supports 4-wire half- or full-duplex operation, or 2-wire half-duplex operation
- ✓ Internal, external or received recovered sync clocking modes
- ✓ Compliant with V.52 BER and V.54 test modes
- ✓ High voltage transformer isolation/surge protection

ORDERING INFORMATION

Ruggedized Industrial Baseband Modems

1065A/120/z: Async/sync, ruggedized, DB25F, RS-232, RJ-45 line, desktop, 120 VAC power

1065A/230/z: Async/sync, ruggedized, DB25F, RS-232, RJ-45 line, desktop, 230 VAC power

1065RC/A/B: Async/sync, DB25F, RS-232, RJ-45 line, rack card

Extended Environmental Industrial Baseband Modems

1065E/A/120/z: Async/sync, extended environmental, DB25F, RS-232, RJ-45 line, desktop, 120 VAC power

1065E/A/230/z: Async/sync, extended environmental, DB25F, RS-232, RJ-45 line, desktop, 230 VAC power

1065RCE/A/B: Async/sync, extended environmental, DB25F, RS-232, RJ-45 line, rack card

Note: More models are available, call for details.

Traffic Monitoring Application

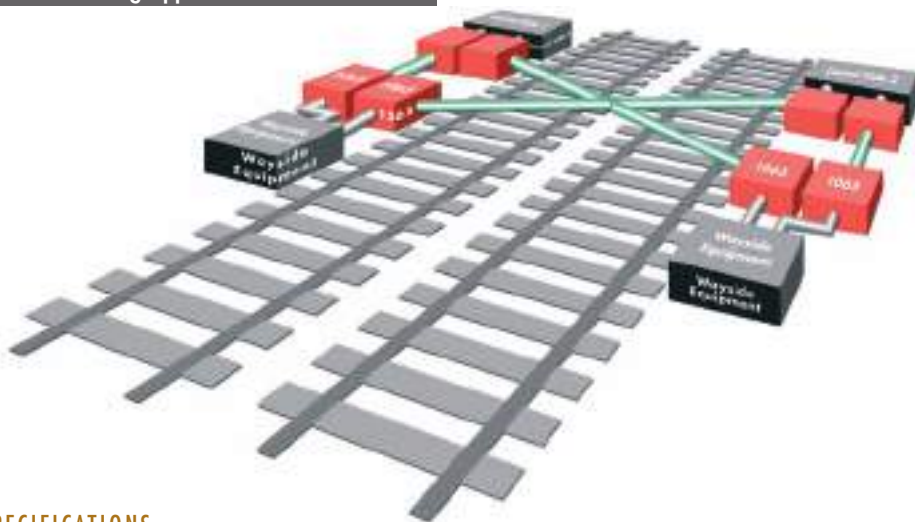

SPECIFICATIONS

Transmission: Sync. or Async., 2-wire/half-duplex, 4-wire/full- or half-duplex, point-to-point or multi-point operation.

DTE Interface: RS-232/V.24, DB-25 female

Line Interface: 2- or 4-wire UTP, 19-26 AWG

Data Rates: Switch-selectable 1.2, 1.8, 2.4, 3.6, 4.8, 7.2, 9.6, 14.4, 19.2, 28.8, 38.4, 57.6, 64 kbps

Clocking: Internal, external, or receive recover

RTS Anti-stream Timer: Switch-selectable for disabled, 12.5 sec, or 50 sec operation.

Diagnostics: V.52 compliant BER pattern (511/511E pattern) generator and detector with error injection mode; V.54-compliant local analog and remote digital loopbacks, activated by front panel switch or RS-232 DTE interface

Carrier: Always-on or controlled by RTS; selectable RTS/CTS delay of no delay, 7, or 53 ms

Isolation: Transformer at 2000 VRMS; Extended models 200Meg. Ohm at 500VDC

Surge protection: Immune to IEC-801-5 Level 2, 1kV

Power: 120/230 VAC switchable; IEC-320 male-shrouded connector

Temp/Humidity: Standard models: 0 to +70°C

with 5–95% relative humidity, non-condensing

Extended models: -10 to +70°C, 100% condensing humidity from -10 to +30°C; Absolute humidity from +30 to +70°C

Dimensions: 5.5W x 7.5D x 1.6H in. (13.9W x 19D x 4H cm)

visit us online
www.patton.com

FAST Delivery From Your AUTHORIZED DISTRIBUTOR!

PATTON
Electronics Co.

Synchronous Modem Eliminators

Models 1200 & 1201

Interconnect sync. equipment at 38,400 bps without a modem.

Have you been using synchronous modems to connect two synchronous DTEs, even though the distance between them is negligible? If so, the Patton Model 1200 synchronous modem eliminator can save you lots of money! Installing between the DTEs, the Model 1200 synchronizes their clocking and matches the wiring. All you need is two straight through RS-232 cables of 150 feet (45.7 m) or less. The Model 1200 requires no AC power or batteries. Handshaking can be set to



emulate dial-up or leased line service. The Model 1201 has LED indicators that monitor TX, RX and CD.

FEATURES & BENEFITS

- ✓ Interface powered—no AC power or batteries required
- ✓ Easy to install and configure
- ✓ Data rates up to 38.4 kbps
- ✓ Cable runs to 150 feet (22.9 m) on either side of the device
- ✓ Constant or RTS controlled carrier
- ✓ Internal or external clocking
- ✓ Variable RTS/CTS delay options

Point-to-Point Application Connecting Two Sync. Host



SPECIFICATIONS

Data Rates: Strap selectable: 1.2, 2.4, 4.8, 9.6, 19.2, 38.4 kbps

Clocking: Internal or external

RTS/CTS Delay: Strap selectable 0, 6.6, 53mS separately for each side

Grounding: Protective ground (pin 1) may be strapped to signal ground (pin 7)

Functional: Emulates half or full duplex, dial-up or dedicated lines

Range: 300 feet (91.5 meters) at 9,600 bps

Data Carrier Detect (Pin 8): "On" or controlled, strap selected separately for each side

Ring Indicator (Pin 22): Continuously "on"

LEDs: Transmit, Receive & Carrier Detect (1201)

Connectors: Choice of two male or two female RS-232 connectors

Power: Derived from RS-232 interface

Dimensions: 3 x 2 x 0.75 in (7.62 x 5.0 x 1.91 cm)

Op. Temp.: 32–122°F (0–50°C)

High Speed Synchronous Modem Eliminators

Models 1202 & 1203

Interconnect high speed synchronous hardware at up to 512 kbps—no modems!

Our Model 1202 & 1203 high speed synchronous modem eliminators let two synchronous RS-232 DTE (host) devices communicate without using expensive synchronous modems. The Model 1202 supports data rates of 16, 32, 64, 128, 256 and 512 kbps. The Model 1203 supports data rates of 17, 14, 28, 56, 112 and 224 kbps. Both models are interface powered and provide internal or external clock options. And both can be configured to emulate dial-up or leased line service. Easily visible LEDs let you monitor link status. RS-232

connections can be extended up to 75 feet (23 m) on either side of the device. Two male or two female DB-25 connectors are provided.



FEATURES & BENEFITS

- ✓ **Model 1202**—Sync data rates from 16 to 512 kbps (including 64 kbps)
- ✓ **Model 1203**—Sync data rates from 7 to 224 kbps (including 56 kbps)
- ✓ Cable runs to 75 feet (23 m) on either side of the device
- ✓ Constant or RTS controlled carrier
- ✓ Internal or external clocking
- ✓ RTS/CTS delay options of 0 msec or 6.6 msec
- ✓ No AC power required

SPECIFICATIONS

Data Rates: Model 1202—up to 512 kbps; 1203—up to 224 kbps

Clocking: Internal or external

Grounding: Protective ground (pin 1) may be strapped to signal ground (pin 7)

RTS/CTS Delay: Strap selectable 0, 6.6, 53mS separately for each side

Functional: Emulates half or full duplex, dial-up or dedicated lines

Ring Indicator (Pin 22): Continuously on

Data Carrier Detect (Pin 8): On or controlled, strap selected separately for each side

Power: Derived from RS-232 interface

Connectors: Choice of two male or two female DB-25 connectors

Dimensions: 3 x 2 x 0.75 in (7.62 x 5.0 x 1.91 cm)

Op. Temp.: 32–122°F (0–50°C)

ORDERING INFORMATION

High Speed Sync Modem Eliminator

1202 F: Two DB-25 female connectors

1202 M: Two DB-25 male connectors

1203 F: Two DB-25 female connectors

1203 M: Two DB-25 male connectors

Note: More models are available, call for details.

V.35, X.21 Synchronous, Modem Eliminators

Models 1205 & 1206

Don't buy expensive modems when there is a better way!

The Patton Models 1205 & 1206 sync modem eliminators enable two synchronous hosts to communicate with each other in the same room for a fraction of the cost of a pair of high speed modems or line drivers.

The **Model 1205**, supporting sync data rates from 32 to 144 kbps, can be configured to emulate dial-up or leased line service. Maximum distance between the connected hosts is 300 feet (91.4 m). Timing can be set for internal, external, or receive recover clock, and all necessary data, clocking and control signals are supported. The Model 1205 implements the V.35 electrical interface on DB-25 female connectors, according to the EIA-530



Standard (DB-25 to M/34 adapter cables are available from Patton.) Operating power is drawn from both V.35 interfaces, or provided via an AC adapter.

The **Model 1206** synchronous X.21 modem eliminator is AC powered, and comes equipped with two DB-15 female connectors. Data rates from 32 to 144 kbps are supported, as well as internal, external or receive recover clocking. Maximum distance between the connected hosts is 300 feet (91.4 m).



FEATURES & BENEFITS

- ✓ **Model 1205**—V.35 sync data rates from 32 to 144 kbps
- ✓ **Model 1206**—X.21 sync data rates to 144 kbps
- ✓ Data, clocking & control signals
- ✓ Internal, external or receive recover clocking
- ✓ AC powered

Our V.35 & X.21 Modem Eliminators are rack mountable

Now you can integrate 16 V.35 or X.21 synchronous modem eliminators into a standard 19-in. rack mount installation that's only 3.5 in. high. Or if you need just a handful of modem eliminators, make your installation ultra compact using our convenient 2, 4, or 8-slot desktop ClusterBoxes™.



SPECIFICATIONS

Data Rates: 32, 48, 56, 64, 72, 112, 128 and 144 kbps
Clocking: Internal or external
Interface: Model 1205—CCITT V.35/EIA RS-530; Model 1206—CCITT X.21
Connectors: Model 1205—Dual DB-25 female; Model 1206—Dual DB-15 female
Distance: 300 ft (91.4 m) (DTE to DTE)
Power: External wallmount transformer, 120 or 230 VAC
RTS/CTS Delay: Strap selectable, 0, 7, 53 mS (±15%)
Dimensions: 3 x 2 x 0.75 in.

ORDERING INFORMATION

- 1205F-F:** Two female DB-25 connectors
- 1205/34F:** Two female M/34 connectors
- 1205RC:** Rack card, two female UD-26
- 1205-26M/35M:** Cable, UD-26 male to M/34 male
- 1205-26M/35F:** Cable, UD-26 male to M/34 female
- 1206F-F:** Two female DB-15 connectors 120 V

- 1206RC:** Rack card, two female UD-26 connectors
- 1206-26M/15M:** Cable, UD-26 male to DB-15 male
- 1206-26M/15F:** Cable, UD-26 male to DB-15 female

Note: More models are available, including 230-V power options and additional cable assemblies, call for details.

Anti-Streaming Device

Model 3001

Miniature device fixes streaming lockups.

This handy device operates in point-to-point or multi-point environments. Supporting any data rate or format, it prevents malfunctioning (streaming) terminal equipment from locking-up the system.



FEATURES & BENEFITS

- ✓ Operates in point-to-point or multi-point environments
- ✓ Prevents malfunctioning (streaming) terminal equipment from locking-up the system
- ✓ Any data rate or format
- ✓ User selectable timeout periods of 12.5, 25, 50 or 400 seconds

ORDERING INFORMATION

- 3001:** Anti-Streaming Device



I'm Dave, Patton's Manager of US Technical Support. If you do not find what you need at www.patton.com or in this catalog, or if you have technical questions or comments, please call me at +1 301.975.1007. You can also send e-mail to puckett@patton.com.



visit us online
www.patton.com

FAST Delivery From Your AUTHORIZED DISTRIBUTOR!



Miniature, Async/Sync RS-232, Fiber Optic Modems**Models 1110A & 1140A**

Have the noise and transient immunity of fiber optics in a miniature, self-powered package!

The Patton Model 1110A and 1140A miniature RS-232 fiber optic modems pack all the advantages of fiber into compact self-powered packages. When it comes to data communication integrity, optical fiber has several advantages over twisted pair copper:

- Copper wire requires shielding against RFI/EMI noise in many environments, whereas fiber is immune to RFI/EMI.
- In building-to-building applications, copper wire requires DC isolation to avoid ground looping. Fiber, since it does not have DC continuity, is not subject to ground looping.
- If a copper link passes through a field of energy created by a lightning strike, this transient energy will be conducted to the hardware at either end. But a fiber link will not pick up this harmful radiated energy—it is immune to transients.

The Models 1110A and 1140A fiber modems have all of these advantages. Neither modem uses AC power or batteries to operate because they draw their power from the data and control signals on the RS-232 interface. Carrier may be internally switch selected for "Continuously On" or "Controlled by RTS".

The **Model 1110A** communicates in full or half-duplex over two fibers while supporting data rates to 19.2 kbps and distances up to 5 miles (8 km). It features an external DCE/DTE switch, which eliminates the need for RS-232 crossover cables. The miniature size of the Model 1110A allows it to fit in tight installation spaces.

**ORDERING INFORMATION**

1110AM-ST: Mini Async Fiber Modem: Male DB-25 & ST Fiber

1110AF-ST: Mini Async Fiber Modem: Female DB-25 & ST Fiber

1110ARC-ST: Async Fiber Modem Rack Card: Female UD-26 & ST Fiber

1110A-26M/25M: UD-26 to DB-25 Male Cable

1110A-26M/25F: UD-26 to DB-5 Female Cable

1140AM-ST: Mini Async Fiber Modem : Male DB-25 & ST Fiber

1140AF-ST: Mini Async Fiber Modem: Female DB-25 & ST Fiber

1140ARC-ST: Async Fiber Modem Rack Card: Female UD-26 & ST Fiber



The **Model 1140A** brings all the advantages of fiber to your network, plus 100% compliant V.52 and V.54 diagnostics. Besides communication integrity, the supports distances to 4 miles (6.4 km) and data rates to 38.4 kbps over two fibers. The 1140A operates async or sync—full or half duplex. While in synchronous mode, the fiber modem supports three clocking methods: internal, external, and receive recover.

Streamline your fiber cabling with Patton's rackmount cards!

If several fiber links are running into the same location, use the 1140ARC rack card. The Model 1140ARC sits in Patton's 16 slot rack chassis, as well as Patton's 2, 4, and 8 slot ClusterBoxes™. Mid-plane architecture and "hot swapping" capability allows different function/interface modules to be plugged in while the system is running.



Uses Patton's Self-Powered Fiber Technology.
Patented: U.S. Patent 4,151,540

**Model 1104
Miniature Async
RS-485 Fiber
Optic Modem
Also Available!**

1140A-26M/25M: UD-26 to DB-25 Male Cable

1140A-26M/25F: UD-26 to DB-25 Female Cable

1104F-ST: Mini Async RS-485 Fiber Modem; Female DB-25; 100–200 VAC

1104M-ST: Mini Async RS-485 Fiber Modem; Male DB-25; 100–200 VAC

1104TB-ST: Mini Async RS-485 Fiber Modem; Terminal Block; 100–200 VAC

Note: More models are available, call for details.

FEATURES & BENEFITS**Models 1110A & 1140**

- ✓ 1110: Async., RS-232 operation/ 1140: Async/Sync RS-232
- ✓ Full or half duplex
- ✓ 1110: Data rates up to 19.2 kbps; 1140: Up to 38.4 kbps
- ✓ 1110: Range up to 5 miles (8 km); 1140: Up to 4 miles (6.4 km)
- ✓ Continuous or controlled carrier
- ✓ External DCE/DTE switch
- ✓ Very thin case (0.75 in./1.9 cm) for closely spaced computer ports
- ✓ EMI/RFI and transient immunity
- ✓ No AC power required
- ✓ ST connector options
- ✓ 1140: V.52 and V.54 loopback test modes
- ✓ 1140: Internal, external or received loopback clocking in sync mode

Model 1104

- ✓ Async. or sync. RS-232 operation
- ✓ Dual fiber optic interface
- ✓ Data rates to 38.4 kbps
- ✓ Range up to 4 miles (6.4 km)
- ✓ No AC power required
- ✓ Continuous or controlled carrier
- ✓ ST connector options

SPECIFICATIONS**Model 1110A & 1140A**

Transmission Line: Dual multi-mode optical cable

Transmission Mode: 1110:

Async., full or half duplex; 1140: Sync or async, full or half duplex

Range: 1110: 5 miles (8 km); 1140: 4 miles (6.4 km) over continuous fiber (with attenuation 2.5 dB/km). Over continuous fiber (with attenuation 2.5 dB/km)

Receiver Sensitivity:—42 dBm

Coupled Output Power: -18 to

-24 dBm (depending on fiber specs)

Optic Wavelength: 850 nm

Indicators: One LED indicates transmission of data

Interface: EIA RS-232/CCITT, V.24

male or female connectors

Data Rates: 1110: 0–19.2 kbps;

1140: 0–38.4 kbps

Power: Derived from EIA data and controls

Dimensions:

1110: 2.66 x 2.10 x 0.73 in.

(6.8 x 5.3 x 1.9 cm)

1140: 3.55 x 2.1 x 0.73 in.

(6.8 x 5.3 x 1.9 cm)

Model 1140A

RS-485 Serial Interface: One DB-25 Male, DB-25 Female, or Terminal Block

Serial Transmission: RS-485 Asynchronous, 0 to 115.2 kbps

Fiber Interface: ST style fiber connectors (TX and RX)

Transmission Line: Dual multi-mode optical cable, optimized to work with 62.5/125 micron fiber—850nm wavelength

Range: Up to 1.25 miles (2.01 km)

Power Budget: 12dB with 62.5/125 micron fiber

Power Supply Options: External Universal Power Supply (100–240 VAC)

Temperature: 32 to 122°F

(0 to 50°C)

Altitude: 0–15,000 ft (0–4,572 km)

Humidity: Up to 95% non-condensing

Dimensions: 3.0L x 1.8W x 0.9H in.

(7.6L X 4.4W X 1.9H cm)

Weight: 2 oz. (57 g)

Note: Country specific power cords are ordered separately.

RS-232 Bluetooth Wireless Modem 2-Packs

Model 1013

The Model 1013 provides hassle-free wireless RS-232 connections with line rates up to 380 kbps at distances up to 3,900 feet (1,188 meters)!



Patton's newest short range modem, the Model 1013, is a wireless serial short range modem that connects RS-232 devices using Bluetooth V.1.1 technology. The Model 1013 eliminates the hassle and expense of running a dedicated cable connection between RS-232 devices thus giving installers, maintenance workers, and others the ability to remotely monitor and control RS-232 devices.

The Patton Model 1013 supports point-to-point and point-to-multipoint connections. Users can configure the Model 1013

through a user-friendly Windows utility application, standard AT commands, or by DIP switch and push buttons. The 1013 includes a plug-and-play auto-pairing button that will automatically link two Model 1013s for a dedicated point-to-point connection.

Serial connections are provided by an RS-232C DB-9 connector. Bluetooth transmits over the built-in stub antenna at distances up to 328 feet (100 meters). For greater distances, Patton offers optional dipole and patch antennas that can increase the wireless RS-232 range up to 3,280 feet (1,188 meters)!

Patton's wireless RS-232 short range modems effectively eliminate the expense and hassle of cables!

FEATURES & BENEFITS

- ✓ RS-232 Serial Cable Replacement—Wireless RS-232 connections can be made over 3,900 feet (1,188 meters) at line rates up to 380 kbps
- ✓ Auto-Pairing Feature—Unique feature that enables plug-and-play installations
- ✓ Windows Utility Configurable—Clear and concise tool for fine tuning your wireless RS-232 connections
- ✓ Bluetooth Protocols Supported—RFCOMM, L2CAP, SDP
- ✓ Interface Powered—No external power supply required for operation



10-BT-PAT



10-BT-DAT



10-BT-UPA



10-BT-DPA

Application diagram



ORDERING INFORMATION

1013: Wireless RS-232 Short Range Modem

1013-2PK: Wireless RS-232 Short Range Modem Extender Kit

Accessories

10-BT-SAT: Bluetooth Stub Replacement Antenna

10-BT-DAT: Bluetooth Dipole Antenna

10-BT-PAT: Bluetooth Patch Antenna

10-BT-UPA: Bluetooth USB to Power Adapter Cable

10-BT-DPA: Bluetooth DC to Power Adapter Cable

10-BT-CBL-1: Bluetooth 1M Antenna Extension Cable

Bluetooth enables wireless RS-232 connections, making installations and service calls more efficient by eliminating the time, hassle, and expense of cable runs.

Antenna Distance Chart	
Default Antenna to Default Antenna	328 feet (100 meters)
Default Antenna to Dipole Antenna	492 feet (150 meters)
Dipole Antenna to Dipole Antenna	656 feet (200 meters)
Patch Antenna to Dipole Antenna	1,312 feet (400 meters)
Patch Antenna to Patch Antenna	3,937 feet (1,200 meters)

SPECIFICATIONS

Bluetooth v1.1
Specifications:
Power Class: Class 1
RF Range: Standard stub antenna up to 328 feet (100m)
Bluetooth Protocol: RFCOMM, L2CAP, SDP
Frequency: 2.4–2.4738 GHz
Baud Rate: Up to 380 kbps
Serial Specifications
Serial Interface: EIA RS-232C

Connector Type: DB-9 Female
Baud Rate: 1,200 bps to 230.4 kbps
Hardware flow control: ON/OFF
General Product Specifications
Operating Temperature: -4 to 158°F (-20 to 70° C)
Dimensions: 2.5L x 1.20W x 0.63H inch (63L x 30W x 16H mm)
Weight: 0.1 lbs (0.06 kg)

visit us online
www.patton.com

FAST Delivery From Your AUTHORIZED DISTRIBUTOR!



Multiplexers

Muxes & Sharing Devices

In This Section

Multiplexers	219
Multiport Async. Multiplexer	219
Low-Speed Time-Division Multiplexer	220
Miniature 2-Port Statistical Multiplexer	220
Powered 8-Channel, Async/Sync	
Statistical Multiplexers	221
4, 6 & 8 Channel Limited Distance Multiplexers ..	222
Modem/Port Sharing Devices	223
Digital Sharing Device (DSD), V.24, 6 Ports	
DCE to 1 DTE	223
Powered RS-232 Modem Sharing Devices	224
Modem Sharing Device	225
Micro Modem Splitter	225
Mini-Rack System & ClusterBoxes	226
Rack Chassis, 2U, 16-Slot	226
Cluster Chassis, 2U, 2-Slot	226
Cluster Chassis, 2U, 4-Slot	226
Cluster Chassis, 2U, 8-Slot	226
Universal Mounting Panel, 2-Slot	228
Universal Mounting Panel, 10-Slot	228
Universal Mounting Panel, 16-Slot	229

Multiplexers

LOW SPEED TDM

Full Duplex, 2-Channel



Connect two sync terminals, or one async and one sync terminal, to a sync modem

- ✓ Data rates up to 19.2 kbps at the sub-channels and 38.4 kbps at the composite channel
- ✓ RS-232 composite port interface and sub-channel interface

Model 3042
Page 220

STATISTICAL MUX

Powered, 8-Channel, Async/Sync



High performance and full front panel LCD control

- ✓ Channel speeds up to 19.2 kbps
- ✓ Link speeds up to 64 kbps
- ✓ Aggregate channel input up to 76.8 kbps
- ✓ RS-232 interface on all ports

Model 3028
Page 221

MINI STAT MUX

Full Duplex, Async



Our MicroStats™ statistical multiplexers double the usefulness of your existing modems!

- ✓ Data rates up to 115.2 kbps and sub-channel data rates to 57.6 kbps
- ✓ Power drawn from main and sub-channel devices—no AC power or batteries required

Model 3032
Page 220

RS-232 TDM

Up to 8 Channels, Limited Distance



Move up to 8 channels of RS-232 data over two twisted pairs

- ✓ Simultaneous sub-channel data rates up to 19.2 kbps
- ✓ Two-pair distances up to 6,000 ft (1.8 km) between multiplexers

Models 3054, 3056, 3058
Page 222

MULTIPOINT ASYNC MUX

Up to 8 Ports on a Single Link



Consolidate up to 8 asynchronous data sources onto a single synchronous WAN link or IP/Ethernet LAN connection

- ✓ V.35/X.21/T1/E1 Ethernet Composite—Connect to any sync dedicated WAN or use standard PPP or Frame Relay networks
- ✓ Up to 8 Ports on a Single Link—Multiplex up to 8 EIA-232/V.24 ports at 115.2kbps

Models 3034, 3038
Page 219

Modem/Port Sharing Devices

DIGITAL SHARING DEVICE

V.24, X.21, or RS-232/423



Share up to 8 ports (DCE or DTE) to 1 master DTE or DCE

Models 3040, 3060, 3080
Page 223

MODEM SHARING DEVICES

V.24, X.21, or RS-232/423



8 sync or async devices can share one modem in a polled environment

Models 3012, 3014, 3018
Page 224

RS-232



Three RS-232 DTEs can contend for access to one RS-232 modem

Model 3010
Page 225

MODEM SPLITTER

DB-25, Sync or Async



Lets three devices share a single modem

Models 305
Page 225

Multiport Asynchronous Multiplexers

Models 3034 & 3038

The Model 3038 IpStatmux Managed Multiport Asynchronous Multiplexer combines up to eight EIA-232/V.24 interfaces over any composite V.35, X.21, T1/E1, or Ethernet/IP port and offers the lowest-cost, most flexible solution for multiport asynchronous terminal connectivity.



Now it is easier than ever to link up multiple asynchronous terminals, hosts, and devices. Patton's Model 3038 IpStatmux Managed Multiport Asynchronous Multiplexer consolidates up to eight asynchronous data sources onto a single synchronous WAN link or IP/Ethernet LAN connection for secure, reliable, and transparent multiplexing.

The Model 3038 offers advanced network and transmission options. The integrated composite port provides a standard synchronous link connection to NTUs, DSUs or traditional WAN services. By including an Ethernet port as a composite

uplink, the Model 3038 also "future proofs" your legacy equipment. Now multiplexed data can use existing LAN, WAN and Internet connections...*simultaneously*. Data security and service quality is ensured with IPSec encryption as well as packet labeling and integrated data QoS with flow-control.

Reliable data is ensured via multiple CRC-16 checks, transparent data checksums and in-order data delivery. In the event of an error, the Model 3038 automatically retransmits the data to ensure transparent and error free delivery. With user configurable flow control including software XON/XOFF, hardware RTS/CTS and combination provides optimal data transfer.

Integrated management offers both local and remote configuration, control and troubleshooting. Use the supervisory port for out-of-band access or use LAN based services such as Telnet, WEB/HTTP and SNMP. Per-port options allow for diagnostics loops, traffic statistics, review channel status and monitor ports and events. Link down, data loss and errors can be signal.

FEATURES & BENEFITS

- ✓ Up to 8 Ports on a Single Link—Multiplex up to 8 EIA-232/V.24 ports at 115.2kbps with individually configurable speed, flow control, echo and testing.
- ✓ V.35/X.21/T1/E1 Ethernet Composite—Connect to any synchronous dedicated WAN or lower costs using standard PPP or Frame Relay networks. Ethernet/IP can be used over any network or Internet without the expense of dedicated lines.
- ✓ Local & Remote Management—Configure and control with Web-based management, SNMP or command line supervisory port all with password protection.

SPECIFICATIONS

Terminal/Channel Ports: Serial Asynchronous start-stop • # of Ports: 8 ports (3038); 4 ports (3034) • Max Aggregate Speed: 2Mbps • Interface: CCITT V.24 (EIA-561) on 8-pin RJ-45F • Data Communication Speed: Selectable 50bps-115.2kbps; auto-speed detection up to 115.2kbps • Data Format: selectable 5,6,7, or 8 bits; 1, 1.5 or 2 stop bits, odd, even, or no parity • Flow Control: Software selectable (XON/XOFF) or hardware (RTS/CTS) in both directions • Break propagation: Transparent • EIA signal propagation: Status of local DTR signal can be propagated to the remote end • Echo: Character echo can be selectively enabled for each terminal port

Composite Port(s): Auto-sensing 10/100BaseTX MDI-X Ethernet & V.35 or X.21 • Error detection & correction: 16-bit CRC-CCITT with ARQ (automatic re-transmission on error) • Speed: selectable, serial up to 1.2Mbps-2Mbps, Ethernet auto detect-10/100 • Interface: DB25, V.35; DB15, X.21 • Data Encoding: NRZ or NRZI • Clock: receive clock: external; transmit clock: selectable as internal or external

Supervisory Port(s): Interface auto-sensing 10/100BaseTX MDI-X on RJ-45 or Serial RS-232 (EIA-561) on RJ-45 • Serial Comm. protocol: asynchronous start-stop • Serial Speed: 300, 1200, 4800, or 9600 bps • Serial Data format: 7/8 bits, odd/even/no parity • Echo: Optional

Commands: Set/modify/view parameters • View status • Store parameters in non-volatile memory • Copy parameters between ports • Provide local/remote loop backs on port • Establish connection between supervisory and terminal ports • Obtain statistic reports • Unit reset; individual port reset • Remote supervisory access • Enable/Disable remote access

IP Services Supported: IPv4 • RIPv1 and v2 (RFC 1058 and 2453) • ICMP redirect (RFC 792); packet fragmentation • DiffServ/ToS set or queue per header bits • Packet policing discards excess traffic • 802.1p/Q VLAN support with 4096 IDs • IPSEC AH & ESP Modes • Manual/IKE keying

IP Connectivity Supported: X.21/V.35 Frame Relay (8PVGs); RFC1490, FR.12 fragmentation; LMI, Q933D, ANSI 617D, Gang of Four; PPPPAPCHAPLCP; T1/E1 (ITU-T G.703, ANSI T1.403; AMI, B8ZS, HDB3) • TCPRAW • UDP • Telnet • DHCP • NAT

Operating Environment: Temp.: 0-40°C • Humidity: 5-80% (non condensing)

System: CPU Motorola MPC859 @ 50 MHz • Memory 16MB SDRAM/4MB Flash • Power: 100-240 VAC (50/60 Hz) • Power dissipation: 4W

Compliance: EMC compliance: EN55022 and EN55024 • Safety compliance: EN 50950 • CE compliance FCC Part 15 Class A

ORDERING INFORMATION

Managed High-Speed RS-232 Async. 8-port Stat Mux

3038/C/EUI: Composite V.35 Sync

3038/D/EUI: Composite X.21 Sync

3038/K/EUI: Composite E1 Sync

Managed High-Speed RS-232 Async. 4-port Stat Mux

3034/C/EUI: Composite V.35 Sync

3034/D/EUI: Composite X.21 Sync

3034/K/EUI: Composite E1 Sync

Managed High-Speed RS-232 Async. 8-port Stat Mux, 2-Pack

3038/C/EUI-2PK: Composite V.35 Sync

3038/D/EUI-2PK: Composite X.21 Sync

3038/K/EUI-2PK: Composite E1 Sync

Managed High-Speed RS-232 Async. 4-port Stat Mux, 2-Pack

3034/C/EUI-2PK: Composite V.35 Sync

3034/D/EUI-2PK: Composite X.21 Sync

3034/K/EUI-2PK: Composite E1 Sync

Application—Remote Office/Branch Office Voice Extension and Access



visit us online
www.patton.com

FAST Delivery From Your AUTHORIZED DISTRIBUTOR!



Low-Speed Time-Division Multiplexer

Model 3042

Connect two sync terminals, or one async and one sync terminal, to a high speed sync modem



The Model 3042 is a full-duplex, RS-232, two-channel, time-division multiplexer (TDM) with an independent switch-selectable V.14/V.22-compliant async-to-sync interface adapter on

sub-channel 1. It provides two channels that can operate as two sync channels or as one sync and one async channel. TDM techniques are used to interleave data from the two channels into a composite channel that operates at twice the rate of the sub-channels. The composite channel is interfaced with a high speed synchronous modem via a straight-through cable.

RS-232 Two-Channel Multiplexer Application

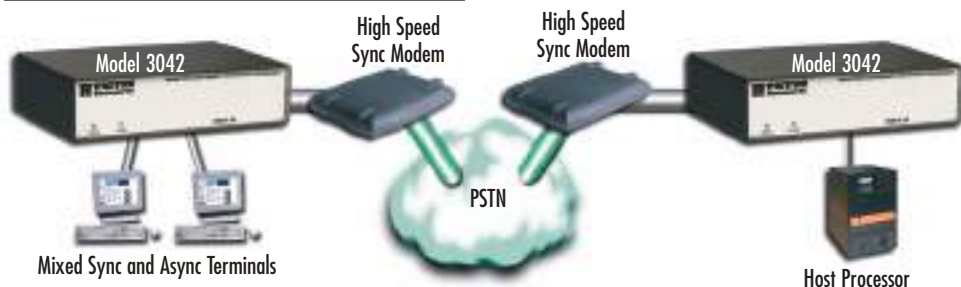

FEATURES & BENEFITS

- ✓ RS-232 composite port interface and sub-channel interface
- ✓ Provides data rates up to 19.2 kbps at the sub-channels and 38.4 kbps at the composite channel
- ✓ Sturdy aluminum enclosure
- ✓ External wall-mounted power supply
- ✓ UL, CSA, and FCC Class A approvals

SPECIFICATIONS

Capacity: Two sync RS-232 terminals or one sync and one async RS-232 terminal multiplexed on one sync RS-232 modem

Data coding: Sync or async

Data interface: EIA RS-232-C

Data rates: Async—600 to 19,200 bps; Sync—up to 19,200 bps; Composite—38,400 bps

Power source: 110 or 220 VAC, 47 to 63Hz, 5 Watts, external wall-mounted transformer

Op. temp.: 32 to 122°F (0 to 50°C)

Rel. humidity: 5 to 90% non-condensing

Dimensions: 2.0H x 8.30W x 6.10D in. (5.08H x 21.08W x 15.49D cm)

Weight: 2.25 lbs (1.02 kg)

ORDERING INFORMATION

3042: Powered V.24 Micro TDM (TDM-V24)

3042-220 Same as 3042 except pre-configured for 220VAC

Miniature 2-Port Statistical Multiplexers

Models 3022 & 3032

Our MicroStats™ double the usefulness of your existing modems!

These devices enable two asynchronous RS-232 devices to communicate over a single modem link, effectively doubling the capacity of two analog (V.32, V.34, etc.) modems or two short-range modems. They also allow four async RS-232 devices to be connected together over short distances (100 ft/30 m) using just a crossover cable. The devices are configured using

extended AT commands (the local and remote mux can be configured from local port 1 or 2) and can perform auto-baud sensing. Hardware (RTS/CTS) and software (X-ON/X-OFF) flow control are supported.



FEATURES & BENEFITS

- ✓ Power drawn from main and sub-channel devices—no AC power or batteries required
- ✓ Model 3022 main and sub-channel data rates to 38.4 kbps
- ✓ Model 3032 main channel data rates to 115.2 kbps and sub-channel data rates to 57.6 kbps

SPECIFICATIONS

Sub-Channels Interface: RJ-45, V.24/RS-232C

Configuration: DCE

Transmission: Async, full duplex

Parity: Odd, even, mark, space, or none

Flow Control: Hardware (RTS/CTS), software (XON/XOFF)

Stop Bits: 1 or 2

Baud Rate: Model 3022—110, 300, 1200, 2400, 4800, 9600, 19200, 38400 bps, selectable or auto detected; Model 3032—110, 300, 1200, 2400, 4800, 9600, 19200, 38400 and 57600 bps selectable (auto detected up to 38.4 kbps)

Main Channel Interface: DB-25 male, DTE, V.24/RS-232-C

Transmission: Async, full duplex

Baud Rate: Model 3022—1.2, 2.4, 4.8, 9.6, 19.2, 38.4 kbps, selectable;

Model 3032—2.4, 4.8, 9.6, 19.2, 38.4, 57.6 and 115.2 kbps, selectable

Word Size: 7 or 8 data bits

Flow Control: RTS/CTS or no flow control

Temp Range: 32–158°F (0–70°C)

Humidity: up to 95%, non-condensing

Dimensions: 2.7 x 2.1 x 7.4 in. (6.9 x 5.3 x 1.9 cm)

ORDERING INFORMATION

3022: 2-Channel Statistical Mux

3032: MicroStat 2-Channel Statistical Mux

Powered 8-Channel, Async/Sync Statistical Multiplexer
Model 3028

Provides high performance and full LCD configuration and management.



These multiplexers are easy to install and operate. The Model 3028 supports up to 8 RS-232 devices, and 1 composite RS-232 port.

The Model 3028 enables you to diagnose problems, check traffic statistics, review channel status and monitor events on the multiplexer and communications line—all from the front panel or a supervisory terminal. The unit combines data traffic from up to eight sources into a single high-speed composite link. Channel speeds from 75 to 19,200 bps are support-

ed with an automatic channel speed detection (AUTOBAUD) option up to 9,600 bps. There is a 16-kbyte buffer that is shared on demand by the channels. Each channel is assigned a minimum of 372 bytes of buffer space to prevent lockout. Due to this buffering action, data rates on the channel side of the multiplexer may total several times the actual link rate without data loss. The 3028 multiplexer can handle an aggregate of 76,800 bps in constant full-duplex traffic (with flow control) and a 64,000 bps link without loss of data.

FEATURES & BENEFITS

- ✓ Model 3028 Turbo—RS-232 interface on all ports
- ✓ Eight channels synchronous or asynchronous
- ✓ Channel speeds up to 19.2 kbps
- ✓ Link speeds up to 64 kbps
- ✓ Aggregate channel input up to 76.8 kbps
- ✓ Independently configurable channels
- ✓ Configurable from the front panel or from a supervisory terminal
- ✓ Local and remote supervisory capability with password protection
- ✓ Internal linear power supply configured for either 110 or 220-VAC operation

3028 Application



I'm John, one of Patton's Ethernet Extenders Product Group Managers. If you do not find what you need at www.patton.com or in this catalog please call me at +1 301.975.1000, x160. You can also send e-mail to jgrant@patton.com.

SPECIFICATIONS

Number of channels: 8
Channel speeds: Up to 19.2 kbps
Link speeds: Up to 64 kbps
Max aggregate speed: 76.8 kbps
Autobaud rate detection: 150 to 9600 bps

Interface standards: EIA RS-232-C, CCITT V.24
Protocols: SDLC/HDLC or asynchronous
Link protocol: Modified HDLC, X.25 Level 2
Error control: 16-Bit CRC
Link timing: Internal: 1.2 to 19.2 kbps; External: to 64K

EIA signal propagation: RTS=DCD, DTR=DSR, BD=RI, DRSS=CTS
Op. temp.: 32–122°F (0–50°C)
Power source: 115/230 VAC, 60/50Hz, 0.16/0.08A, switchable, UL approved

Rel. humidity: 5 to 90% non-condensing
Dimensions: 1.75H x 17.0W x 11.00 in. (4.44H x 43.18W x 18.93D cm)
Weight: 4.5 lbs (2.1 Kg)

ORDERING INFORMATION

- 3028 TURBO:** Powered statistical multiplexer, RS-232, 8-channel
- 3028-220 TURBO:** Same as 3028 Turbo except pre-configured for 220VAC

visit us online
www.patton.com

FAST Delivery From Your AUTHORIZED DISTRIBUTOR!



4, 6 & 8 Channel Limited Distance Multiplexers

Models 3054, 3056, & 3058

These RS-232 TDMs have Built-in Short Range Modems!

The Patton Model 305X Series limited distance multiplexers combine two functions into one handy product. First, each Model 305X Series unit is a time division multiplexer (TDM), multiplexing 4, 6 or 8 individual RS-232 devices onto a single composite channel. Second, each Model 305X Series unit is a short range modem, supporting point-to-point communication at distances up to 6,000 ft (1.8 km) over two unconditioned twisted pairs. All Model 305X Series units support end-to-end software flow control, and are equipped with local and



remote loopback tests. (The Model 3054 and 3056 also support RTS/CTS hardware flow control.) In addition, diagnostic LEDs show each sub-channel's status. All data interfaces are ported to modular RJ-45 jacks.

FEATURES & BENEFITS

- ✓ Multiplexes 4, 6 or 8 async devices onto two twisted pairs
- ✓ Simultaneous sub-channel data rates up to 19.2 kbps
- ✓ Two-pair distances up to 6000 ft (1.8 km) between multiplexers
- ✓ Support for RS-232 interfaces on modular RJ-45 connectors
- ✓ End-to-end software flow control
- ✓ Hardware (RTS/CTS) flow control (Models 3054 & 3056)
- ✓ Local and remote loopback tests
- ✓ LEDs monitor TD, RD (each sub-channel), link and diagnostics
- ✓ Miniature plastic enclosure fits in tight installation spaces

Typical Application



SPECIFICATIONS

Transmission Lines: Main channel, 19 to 26 AWG twisted pair; RS-232 sub-channels, flat silver cable
Interfaces: Asynchronous RS-232, ITU/CCITT
Data Rates: 0–19.2 kbps on sub-channels
Test Modes: Local loopback, remote loop
Range: 6,000 ft (1.8 km) over twisted pair 24 AWG (0.5 mm) between multiplexers; 50 feet (15.2 m) on RS-232 sub-channels
Indicators: Transmit Data, Receive Data, Link, Local Loopback, Remote Loop
Connectors: RJ-45 female on main & sub-channels
Power Supply: 9–12 VAC
Dimensions: 8.5W x 3.5L x 1.5H in. (21.6W x 8.9L x 3.8H cm)



I'm Scott, Patton's Vice President of Product Management. If you do not find the answers you need at www.patton.com, please call me at +1 (301) 975-1000 x166. You can also send e-mail to scott@patton.com.

ORDERING INFORMATION

- 3054/A: 4-Port, RS-232
- 3054/AR: 4-Port, RS-232, w/ RTS/CTS flow control
- 3056/A: 6-Port, RS-232
- 3056/AR: 6-Port, RS-232, w/ RTS/CTS flow control
- 3058/A: 8-Port, RS-232

Note: Available with either 120V or 230V power. Please specify.

Digital Sharing Devices

Models 3040, 3060, & 3080

Expand your systems without acquiring additional data lines or modems.



Model 3040/V35, 3060/V24, 3060/X21, and 3080/V24 Digital Sharing Devices (DSD) act as combined modem and port sharing devices. With any of these high-speed bi-directional units, up to eight DCE or DTE devices can share one DCE or DTE device in a polled or contention environment. Sub-channels contend for the main channel by activating RTS, DCD, or by detecting data transitions.

Clock signals are provided either by an external modem connected on the master port, or by the internal baud rate generator (which provides rates up to 2,048kbps). In addition, any sub-channel port can be configured to provide clocking

so that if the clock signal provided by the master source fails—or if DCD on sub-channel 1 becomes inactive—the DSD will use the internal clock or a sub-channel clock.

To prevent network lockups, DSDs have anti-streaming features that automatically removing a defective sub-channel from service. Each DSD sub-channel can be configured for DTE or DCE operation. Each channel can be set for Data or Interface Lead contention.

Each DSD comes with an internal power supply that can be set by a switch for 110- or 220-VAC operation.

FEATURES & BENEFITS

- ✓ Contention via RTS, DCD or data transitions, individually selectable in each sub-channel
- ✓ 64-bit tail circuit buffer (TCBs) included
- ✓ Internal or external clock
- ✓ Dial-up modem support
- ✓ Operation is transparent to data
- ✓ Sturdy rack-mountable enclosure (rack mount kit included)
- ✓ Individual sub-channel enable/disable switches
- ✓ Internal power supply; switch selectable for 110 or 220-VAC
- ✓ UL, CSA, TÜV, and FCC Class A approvals for all models; CE approval for Models 3080/V24 and 3060/X21



SPECIFICATIONS

Capacity: Sync/async DTE or DCE devices (6 for the 3060/V24 and 3060/X21, and 8 for the 3080/V24)
Tail circuit buffering: Uni-directional 8-bit ring buffer
Anti-streaming: Automatic—selectable time-out intervals or disable
Sub-channel and modem interface: 3060/V24—RS-232 using DB-25s; 3060/X21—V.11 using DB-25s; 3080/V24—RS-423 using DB-25s
Data rates: 3040/V35—up to 2 Mbps; 3060/V24—up to 76.8 kbps; 3060/X21—up to 2 kbps; 3080/V24—up to 128 kbps
Weight: 4.5 lbs (2.1 kg)
Timing: Internal—DIP switch selectable; Normal—from modem;

External—clock provided on any sub-channel, with fallback to internal clock or sub-channel
Power source: 100–120/200–240 VAC, 50/60 Hz, 0.16/0.08A, switch selectable
Humidity: 5–90% non-condensing
Terminal service modes: Scanning—channels are continuously scanned for RTS/DCD or DATA on a sequential basis; Priority—channels are continuously scanned for RTS/DCD or DATA, channel 1 has highest access priority
Op. temp.: 32 to 122 °F (0 to 50 °C)
Dimensions: 1.75H x 17.00W x 11.00 in. (4.44H x 43.18W x 18.93D cm)

ORDERING INFORMATION

- RS-232/423 DSD, 8 ports DTE or DCE to 1 master DTE or DCE
- 3080/V24: 120 VAC version
- 3080/V24-220: 220 VAC version

Typical Application

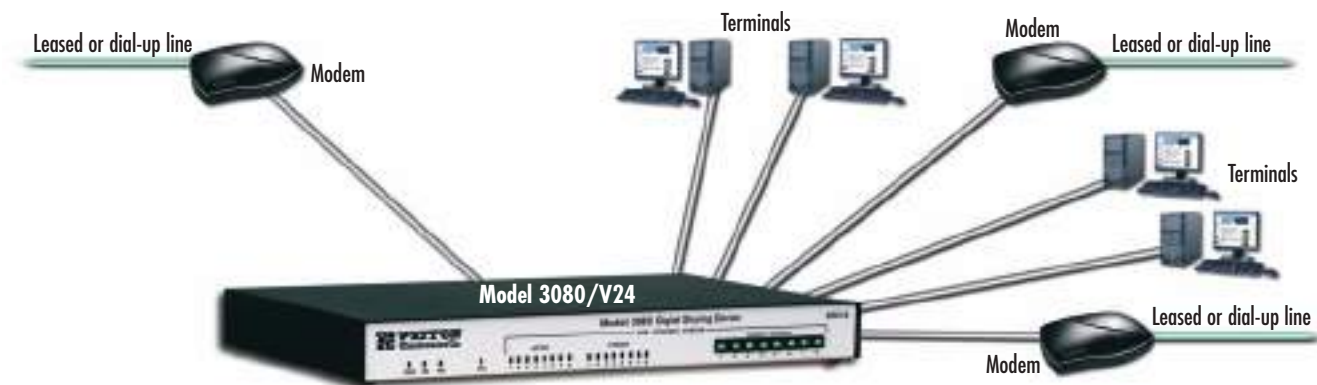

visit us online
www.patton.com

FAST Delivery From Your AUTHORIZED DISTRIBUTOR!



Powered RS-232 Modem Sharing Devices Models 3012, 3014, & 3018

Now eight sync or async devices can share one modem in a polled or contention environment.



The Models 3012/V24 and 3014/V24 Modem Sharing Devices (MSDs) enable users to expand their polled or contention networks without acquiring additional data lines or modems. DSDs act as combined modem and port sharing devices.

With any of these bi-directional units, up to eight sync or async terminal devices can share one modem in a polled or contention environment. Data arriving at the master port is continually broadcast to all sub-channels. The first sub-channel to activate RTS automatically controls the master port. When RTS is deacti-

ated, the MSD enables any other sub-channel to take control of the master port. Sub-channels contend for the main channel by activating RTS, DCD, or by detecting data transitions. Clock signals are provided by the modem connected to the master port, at data rates from 75 bps to 64 kbps (properly shielded, low capacitance cables must be used for speeds faster than 38.4 kbps) and faster.

MSDs have optional anti-streaming features that prevent network lockups by automatically removing a defective sub-channel from service.

FEATURES & BENEFITS

- ✓ Speed/code transparency up to 64 kbps
- ✓ Operation is transparent to data
- ✓ Individual sub-channel enable/disable switches
- ✓ Selectable RTS/CTS time delay
- ✓ Fully cascadable
- ✓ Internal power supply; switch selectable for 110- or 220-VAC



I'm Natalie, Patton's Inside Sales Manager, US & Canada. Call me at +1 301.975.1000 when you want to purchase Patton products or if you have questions about our products. You can also send e-mail to sales@patton.com.



Multiple RS-232 sync/async terminal devices sharing one RS-232 modem link in a polled environment



SPECIFICATIONS

Capacity: One to Eight RS-232 sync/async DTE devices; One RS-232 DCE master channel

Data format: Data is transparent at all data rates

Data rates: Up to 64 kbps (properly shielded, low capacitance cables must be used for speeds faster than 38.4 kbps)

Sub-channel interface: RS-232 (V.24) using female DB-25 connectors

Timing: External—from master port, sub-channel 1 pin 24 routed to master port

Modem interface: RS-232 (V.24) using a female DB-25 connector

Terminal service modes: Scanning—channels are continuously scanned for RTS on a sequential basis; Priority—channels are continuously scanned for RTS, channel 1 has highest access priority

Anti-streaming: Automatic—selectable time-out intervals

Power source: 100-120/200-240 VAC, 50/60 Hz, 0.16/0.08A, switch selectable

Weight: 3012/V24: 2.25 lbs (1.02 Kg)
3014/V24: 4.5 lbs (2.1 Kg)

Op. temp.: 32–122°F (0–50°C)

Rel. humidity: 5–90% non-condensing

Dimensions:

3012/V24: 1.75H x 8.90W x 10.00 in. (4.44H x 22.60W x 25.40D cm)

3014/V24: 2.05H x 13.35W x 9.00 in. (5.21H x 33.09W x 22.86D cm)

ORDERING INFORMATION

3012/V24: Powered RS-232 MSD, 2 V.24 DCE ports to 1 V.24 master DTE

3012/V24-220: Same as 3012/V24 except pre-configured for 220VAC

3014/V24: Powered RS-232 MSD, 4 V.24 DCE ports to 1 V.24 master DTE

3014/V24-220: Same as 3014/V24 except pre-configured for 220VAC

Modem Sharing Device

Model 3010

Lets three RS-232 DTEs contend for access to one RS-232 modem

The Model 3010 modem sharing device lets three RS-232 DTEs contend to transmit data to one DCE such as a modem or mux. Supporting asynchronous or synchronous data rates to 38.4 kbps, the Model 3010 passes data and control signals in parallel from the modem to all three DTEs. Each DTE may also raise RTS to contend for the right to transmit exclusively to the modem. If two DTEs raise RTS simultaneously, the Model 3010 prioritizes access by port (1-2-3). The Model 3010 requires no AC power or batteries, no configuration, and plugs directly into the modem or multiplexer's DB-25 port.



FEATURES & BENEFITS

- ✓ Async or sync operation (transparent to protocol)
- ✓ No AC power or batteries required
- ✓ Prioritized monitoring scheme uses RTS contention
- ✓ Modem transmits in parallel to each connected DTE device
- ✓ Miniature size plugs into modem port



Typical Application

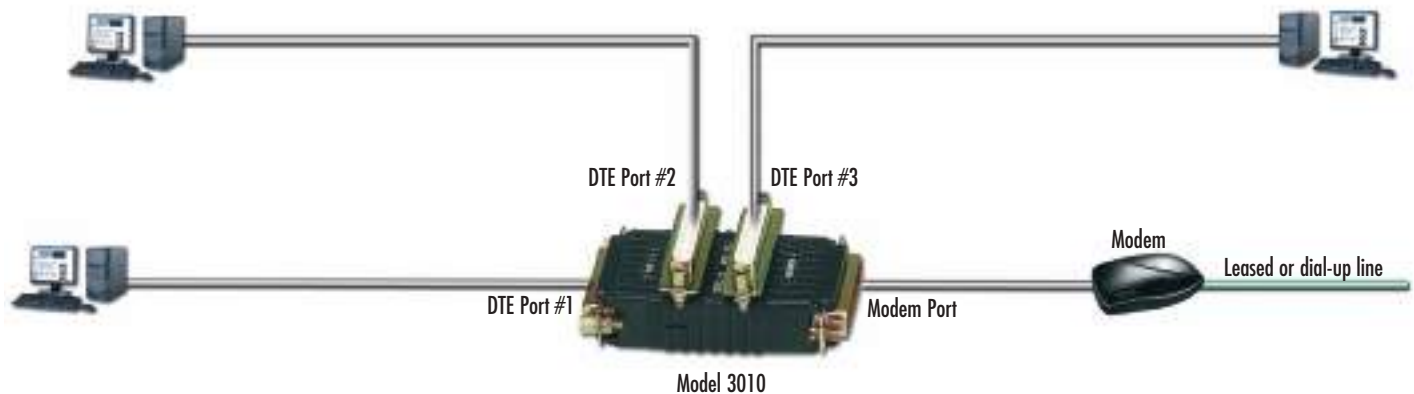

SPECIFICATIONS

Data Rates: 300 bps to 38.4 kbps
Transmission Format: Async or Sync (transparent to protocol)
Transmission Mode: Full or half duplex

Contention Method: Controlled by RTS
Interface: EIA RS-232/CCITT V.24
Dimensions: 3.13 x 2.11 x 1.20 in. (8 x 5.4 x 3 cm)

Connectors: DB-25 male on modem (DCE) interface, DB-25 female on DTE interfaces
Op. Temp.: 32–122°F (0–50°)

Power: Derived from RS-232 data and control signals, no AC power or batteries required
Humidity: Up to 95% non-condensing

ORDERING INFORMATION

3010: Modem Sharing Device

Micro Modem Splitter

Model 305

Lets three devices share a single modem

The Model 305 Micro Modem Splitter is a passive device that connects up to three computers to a single modem. The splitter is transparent to data format. The DTE pins 2, 4, and 20 are isolated to the modem port; all other pins are passed straight through. The Model 305 supports sync or async operation



FEATURES & BENEFITS

- ✓ Completely passive device
- ✓ DTE pins 2, 4, and 20 are isolated to the modem port; all other pins are passed straight through
- ✓ Transparent to data format
- ✓ Sync or async operation

ORDERING INFORMATION

305: Modem Splitter

Mini-Rack System and ClusterBoxes™

Models 1000R16, 1000CU2, 1000CU4, & 1000CU8

Multiple datacom devices fit side-by-side in our mini-rack and ultra-compact ClusterBoxes!



Our miniature rack cards have a unique design: front function cards and rear interface cards that connect together on a midplane power bus. This configuration allows interface cables to remain connected while function cards are hot-swapped (and vice versa). Each mini-rack and ClusterBox has a power supply that services all cards in the chassis. You can configure the mini-rack and ClusterBoxes with a

variety of function cards (short-range modems or SRMs, fiber modems, converters, etc.) and you can mix-and-match function cards with different interface cards.



16 ports fit a wide variety of Patton products—from CSU/DSUs to short-range modems to converters.

Choose from a variety of rear interfaces: DB-25, RJ-11, RJ-45, UD-26, etc.

FEATURES & BENEFITS

- ✓ Multi-function—Supports interface converters, CSUs, fiber modems and virtually all Patton mini-modems.
- ✓ Hot-swappable—Replace function cards *without turning off the power*.
- ✓ Reliable—Our distributed power system gives each rack card its own power supply circuit
- ✓ Flexible—Convenient rack mount and ClusterBox versions are available to meet your needs

SPECIFICATIONS

Environmental
 Op. Temp.: 32–122°F (0–50°C)
 Humidity: 5–90%, non-condensing

24 VDC Power
 Input Voltage: 18–36 VDC
 Input Current: 2A Max at 18 VDC
 Surge Protection: Triggered at 39 VDC
 Output Voltage: 12 VAC at 2A
 Output Power: 24 W
 LED indicators: Power, DC Input

48 VDC Power
 Input Voltage: 40–80 VDC
 Input Current: 1A Max at 40 VDC
 Surge Protection: Triggered at 75 VDC
 Output Voltage: 12 VAC at 2A
 Output Power: 24 W

LED indicators: Power, DC Input
120 VAC Power
 Input Voltage: 100–230 VAC
 Input Current: 400 mA
 Output Voltage: 10 VAC at 2.4 A
 Output Power: 24 W
 LED indicator: Power

220 VAC Power
 Input Voltage: 200–240 VAC
 Input Current: 200 mA
 Output Voltage: 10 VAC at 2.4 A
 Output Power: 24 W
 LED indicator: Power

Device type	Standalone Model	Compatible Rack Card	Rack Card (RC) Description (Configuration)	Page	Device type	Standalone Model	Compatible Rack Card	Rack Card (RC) Description (Configuration)	Page
Plug-in Short-Range Modems (SRM)	1000 Series	1000RC	Async SRM dual RC	79	Powered Short-Range Modems (SRM)	1050 Series	1060RC	115.2 Async. SRM RC	86
	1004A Series	1004ARC	High speed multipoint dual RC	81		1060 Series	1060RC	115.2 Async. SRM RC	86
	1005 Series	1000RC	Async SRM dual RC	79		1070 Series	1070RC	Sync. SRM RC	87
	1008 Series	1004ARC	High speed multipoint dual RC	81		1080A Series	1080ARC	57.6 Async./Sync. SRM RC	88
	1009 Series	1000RC	Async SRM dual RC	79	Fiber Modems	1110A Series	1110ARC	Fiber SRM RC	92
	1010B Series	1010RC	Trans Isolated SRM dual RC	79		1140A Series	1140ARC	Fiber Optic Modem w/V.54 Diagnostics	92
	1010R Series	1010RC	Trans Isolated SRM dual RC	79	Converters & Modem Eliminators	1205 Series	1205RC	V.35 Sync. Modem Eliminator RC	91
	1012A Series	1012ARC	Async., multipoint SRM dual RC	82		1206 Series	1206RC	X.21 Sync. Modem Eliminator RC	91
	1015 Series	1000RC	Async SRM dual RC	79		2020 Series	2020RC	CCITT V.35 to RS-232 Converter RC	50
	1016 Series	1010RC	Trans Isolated SRM dual RC	79		2016 Series	2066RC	CCITT V.35 to X.21 Converter w/Buffer	49
	1017 Series	1010RC	Trans Isolated SRM dual RC	79		2085 Series	2085RC	RS-232 to RS-485 Converter dual RC	54
	1018 Series	1018RC	SLIP/PPP SRM RC	85		2089 Series	2085RC	RS-232 to RS-485 Converter dual RC	54
	1019 Series	1010RC	Trans Isolated SRM dual RC	79		222N Series	222NRC	RS-232 to RS-422 Converter dual RC	56
	1020 Series	1080ARC	57.6 Async./Sync. SRM RC	88		222N9 Series	222NRC	RS-232 to RS-422 Converter dual RC	56
	1025 Series	1080ARC	57.6 Async./Sync. SRM RC	88		2703 Series	2703RC	2 Mbps G.703 Modem Access Converter	41
	1030 Series	1080ARC	57.6 Async./Sync. SRM RC	88					
1035 Series	1045RC	32, 56 & 64 kbps Async./Sync. SRM RC	85						
1040 Series	1080ARC	57.6 Async./Sync. SRM RC	88						
1045 Series	1045RC	32, 56 & 64 kbps Async./Sync. SRM RC	85						



1000CU2—Our 2-Slot ClusterBox™ has about the same footprint as a standalone box, but gives you the flexibility of a rack.



1000CU4—Our 4-slot ClusterBox™ is perfect for an office or workgroup connection. It services four to eight devices



1000CU8—When you don't need a full rack, our 8-slot ClusterBox™ gives you the power of up to 16 short hauls or converters in a single enclosure.

ORDERING INFORMATION

Factory part number encoding

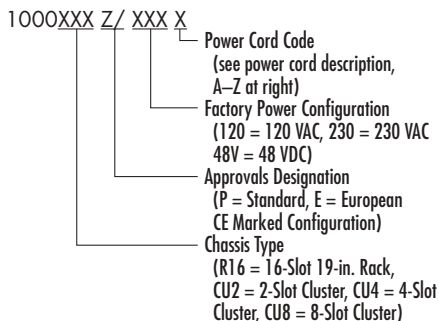

Pre-Configured Rack Assemblies

Example 19-in. 2U rack chassis

1000R16P/120K: 120 VAC power module (includes power cord for U.S.A.)

1000R16E/230D: CE compliant, 230 VAC power module (includes power cord for U.K.)

1000R16P/230G: 230 VAC power module (includes power cord for India)

1000R16P/48V: 48 VDC Power Supply

1000R16P/24V: 24 VDC Power Supply

Example Desktop ClusterBoxes™

1000CU2P/120K: 2-Slot Cluster Unit with 120 VAC power module (includes power cord for U.S.A.)

1000CU2E/230D: 2-Slot Cluster Unit with CE compliant, 230 VAC power module (includes power cord for U.K.)

1000CU2P/48V: 2-Slot Cluster Unit with 48 VDC Power Supply

Rack System Parts

Empty Rack

1000R16P: 19-in. 16-Slot Rack Chassis Sub-Assembly

Empty Cluster Chassis

1000CU2: ClusterBox-II 2-Slot Desktop Cluster Sub-Assembly

1000CU4: ClusterBox-IV 4-Slot Desktop Cluster Sub-Assembly

1000CU8: ClusterBox-VIII 8-Slot Desktop Cluster Sub-Assembly

Rear Power Entry Modules

1000RPEM-DC: DC Rear Power Entry Module

1000RPEM-RDC: DC Redundant Rear Power Entry Module

1000RPEM: Standard 120/230 VAC Rear Power Entry Module

1000RPEM-V: CE Compliant 120/240 VAC Rear Power Entry Module

Front Power Supply Modules

1000RPSM-2: 120/230 VAC Front Power Supply Module

1000RPSM-V: CE Compliant Front Power Supply Module

1000RPSM-48A: 48 VDC Front Power Supply Module

1000RPSM-R48A: 48 VDC Redundant Front Power Supply Module (2 Required)

1000RPSM-24A: 24 VDC Front Power Supply Module

1000RPSM-12A: 12 VDC Front Power Supply Module

Power cord sets

0805US: "K" American Power Cord

0805EUR: "A" European Power Cord CEE 7

0805UK: "D" United Kingdom Power Cord

0805AUS: "C" Australia Power Cord

0805DEN: "E" Denmark Power Cord

0805FR: "F" France/Belgium Power Cord

0805IN: "G" India Power Cord

0805IS: "H" Israel Power Cord

0805JAP: "J" Japan Power Cord

0805SW: "L" Switzerland Power Cord

Spare parts, hardware, fuses, panels

05R16FPB1: Single-width Blank Front Panel

05R16FPB4: 4-Slot-Wide Blank Front Panel

05R16RPB1: Single-Width Blank Rear Panel

05R16RPB4: 4-Slot-Wide Blank Rear Panel

0821R4: Fuse, 0.4A (5x20mm)

0821R2: Fuse, 0.2A (5x20mm)

056S1: 16 #4 pan head screws & washers



I'm Brian, one of Patton's Product Validation Engineers who makes sure your mini-rack product works reliably. To buy one of these state-of-the-art devices, call +1 301.975.1000 or send e-mail to sales@patton.com.

10 and 2-Slot Universal Mounting Panels

Models 1001MP10 & 1001MP2

Rack, stack, and organize up to 10 Patton devices with these multi-functional mounting panels.



Model 1001MP10

The Model 1001MP10 Universal Mounting Panel offers the ability to rack up to 10 Patton products side by side. Products that are compatible with the 1001MP10 and 1001MP2 include Ethernet Extenders, xDSL modems, short range modems, NTUs, and much more!



Model 1001MP2

The Model 1001MP10's sturdy 4U design easily installs into any standard 19-inch rack. A combination of a unique groove system and an easily installed back panel enables the 1001MP10 to securely lock the individual Patton modems and their power supplies. For lower density applications, the Model 1001MP2 offers a 1.5U-high, 2-slot panel.



1001MP10 rear view

10 rear slots for device power supplies

The Model 1001MP series offers a convenient method for converting your favorite Patton standalone product into a rack-mounted solution.

FEATURES & BENEFITS

- ✓ Multi-Functionality—Supports NTUs, xDSL Modems, Short Range Modems, and Ethernet Extenders.
- ✓ Independent Slots—Up to 10 independently operating slots to completely do away with any single point of failures.
- ✓ Rackmount—Both Universal Mounting Panels fit into any 19-in. rack. The 10-slot panel is only 4U (7 in./17.78 cm) high. The 2-slot is 1.5U (2.63 in./6.68 cm) high.
- ✓ Cost-Effective—Rack-mount products you have already purchased.

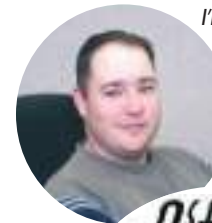

I'm John, one of Patton's Product Group Managers. If you do not find what you need at www.patton.com or in this catalog please call me at +1 301.975.1000, x160. You can also send e-mail to jgrant@patton.com.



Patton Product Compatibility Table

xDSL Modems	E1/T1 Network Extenders	E1/T1 NTU	Ethernet Extenders	Serial Short-Range Modems
1082: iDSL Modem	2113: T-Link E1 Extender	2701 Series: G.703/G.704 FE1/E1 NTU	2155: 144 kbps CopperLink Extender	1060: RS-232 115.2 kbps Asynchronous SRM
3088: G.SHDSL Modem	2115: T-Link T1 Extender	2707 Series: G.703 Clear Channel E1 NTU	2156: 2.3 Mbps CopperLink Extender	1070: RS-232 19.2 kbps Synchronous SRM
3201: 2.3 Mbps G.SHDSL Router		2720 Series: T1/FT1 NTU	2157: 4.6 Mbps CopperLink Extender	1080A: RS-232 57.6 kbps Async/Sync SRM
3241: 4.6 Mbps G.SHDSL Router			2158: 10 Mbps CopperLink Extender	1080A-64: RS-232 64 kbps Async/Sync SRM
1068: VDSL Modem			2168: 16 Mbps CopperLink Extender	1226: Parallel 115.2 kbps SRM
			2172: 50 Mbps CopperLink Extender	1075: X.21 64 kbps Sync SRM
				1226: RS-232 38.4 kbps Async SRM

SPECIFICATIONS

1001MP10

Front Panel: 10 independently operating slots

Dimensions: 19 L x 6.75 W x 7 H in. (48.3 L x 17.15 W x 17.78 H cm)

Weight: 4.15 lbs (1.90 kg)

1001MP2

Front Panel: 2 independently operating slots

Dimensions: 19.0 W x 2.63 H x 1.9 D in. (48.3 W x 6.68 H x 4.8 D cm)

Weight: 2 lbs (0.95 kg)

ORDERING INFORMATION

1001MP2: 19-in. Horizontal 2-Slot Rack

1001MP10: 19-in. Vertical 10-Slot Rack

16-Slot Universal Mounting Panel

Model 1001MP16

Rack, stack, and organize with Patton's Multi-Functional Universal Mounting Panel. Rack up to 16 Patton MicroPak Devices into a dense 2U solution.



Rack-Mount any of Patton's MicroPak Products

FEATURES & BENEFITS

- ✓ Mount any MicroPak—Supports media converters, terminal servers, Ethernet bridges, fiber modems, CSU/DSUs, interface converters, short haul modems, and surge protectors
- ✓ Low Profile-2U High—Universal Mounting Panel is only 2U (3.5 in. or 8.9 cm) high and holds up to 16 MicroPaks; Installs quickly into any standard 19 inch rack
- ✓ Dry-erase label blocks and port identification numbers for easy circuit identification
- ✓ Cost Effective—Adapt Patton MicroPak products you already own for use in a standard 19 inch rack, thereby eliminating the expense of upgrading to rack-mounted equipment

The Model 1001MP16 Universal Mounting Panel offers the ability to rack-mount any of Patton's MicroPak products side-by-side. Products that are compatible with the 1001MP16 include Device servers, Media converters, Ethernet bridges, Fiber modems, Interface converters, and many more!



The sturdy 2U design of the 1001MP16 enables quick and hassle-free installation into any standard 19-inch rack. The 1001MP16's unique bracket-and-groove mounting system enables Patton MicroPak cases to be mounted securely into the panel. Dry-erase labels and individually numbered ports are provided for easy circuit/port identification.

The Model 1001MP16 provides an economical method for converting your favorite Patton standalone MicroPak products into a customized rack-mounted solution.



Back View

Unique bracket-and-groove system fastens the MicroPak securely into the panel

Patton Product Compatibility Table

VoIP Micro-ATAs & AFAs		Device Servers		Serial Modems		Surge Protectors	
M-ATA	M-AFA	2120 Series	2120/A9	1000R Series	1012AR Series	503PC	570 Series
				1007 Series	1017 Series	534 Series	580 Series
				1010R Series	1052 Series	547 Series	552 Series
Serial/Parallel Converters		Ethernet Bridges		Data Taps		Interface Converters	
2026P	2036P	2121 Series	2135C Series	3/11	3/45	1104 Series	2086 Series
		2124 Series	2135 Series			2016 Series	2070 Series
		2130 Series				2021 Series	2702 Series
						2040 Series	2090 Series
						2041 Series	2094 Series
						2042 Series	
Baluns		CSU/DSUs		Modem Eliminators			
460 Series	470 Series	2710 Series	2715 Series	1205 Series	1206		
462 Series	471 Series	2711 Series	2400 Series				
463 Series	472 Series						
465 Series							

and many more...

SPECIFICATIONS

Front panel: 16 Operationally independent slots
Dimensions: 19L x 1.5W x 3.8H in. (48.3L x 3.8W x 8.9H cm)
Weight: 1.1 lbs (0.5 kg)

Latching: 16 individual steel clips with hardware (Included with unit)
Power: None required. Some units may require individual power supplies

ORDERING INFORMATION

1001MP16: 19-inch, 16-Slot Mounting Panel
 1001MP-PS8: 8-Barrel 5V, 4A Power Supply

Surge Protection

Workstation Port Protection

RS-232

DB-25

DB-9



These asynchronous surge protectors guard RS-232 data and control signals against harmful transients. Ideal for situations where you have equipment such as multiplexers, repeaters, concentrators, and short-range modems connected to long lengths of cable, they protect against signal noise and surges.

- ✓ Protect your expensive communications equipment from line-to-line and line-to-ground transients.
- ✓ Highly sensitive avalanche-diode circuitry
- ✓ Install quickly and easily
- ✓ Available with DB-9 and DB-25 connections

Model 501
Page 232

Model 509
Page 232

RS-232 & RS-422

RJ-11, RJ-12, & RJ-45



These ultra-miniature protectors fit almost anywhere and handle transient surges up to 600 watts per wire.

- ✓ Surge handling capacity of up to 4,800 watts
- ✓ Install quickly and easily
- ✓ 6-in. (15.2 cm) extension cable included

Model 510
Page 233

TERMINAL BLOCKS

Universal



Design your own "custom" surge protectors to fit just about any 2, 4, 6, 8, or 10-wire application.

- ✓ Surge handling capacity of 1,500 watts
- ✓ Highly sensitive avalanche-diode circuitry
- ✓ 7.5 V and 18 V clamping voltage options

Model 52X
Page 239

PARALLEL

Centronics or DB-25



When you're protecting your computer's data lines from transient surges, don't forget the parallel ports. The relatively low voltages of parallel signals make them surge-sensitive!

- ✓ Protects all parallel interface pins
- ✓ Surge handling capacity of 1,500 watts
- ✓ Centronics or DB-25 options

Model 503P
Page 233

X.21

DB-15



Protects any X.21, RS-232, RS-422/485, or T1 interface port that uses a DB-15 connector.

- ✓ Data rates up to 20 Mbps
- ✓ Clamping voltage options for RS-232/485, X.21, and T1
- ✓ Highly sensitive avalanche-diode circuitry

Model 515
Page 232

10/100 BASE-TX

CAT-5 Certified



These 10/100Base-TX surge protectors are EIA/TIA TSB-40A Category-5 certified, and can protect your RS-422/423, Token Ring, and ATM equipment too!

- ✓ Install at equipment locations (570) or wiring closets (580)
- ✓ Complies with transient immunity standards IEC 801-2, 801-4, & 801-5
- ✓ PoE 802.3af

Model 570/580
Page 234

WAN Port Protection

DIAL-UP

Protects Phones, Faxes, Modems



2- or 4-Wire dial-up protectors

Model 552-D
Page 238

LEASED LINE

Protects Analog Devices



4-Wire leased-line protector

Model 552-L4
Page 238

ISDN

Protects TAs & NTUs 'U' & 'ST'



8-Wire ISDN protector ST Type

Model 552-ST
Page 238

DDS

Protects 56/64k CSUs



4-Wire DDS protector

Model 552-DDS
Page 238

T1/E1

Protects 1.544 & 2.048 Mbps CSUs



4-Wire T1, E1, & ISDN PRI protector

Model 552-T1
Page 238

V.35

Protects Modems, CSU/DSUs, etc.



Plugs directly into V.35 ports, so you won't need cables

Model 546
Page 237

Surge Protectors for Every Application

In This Section

10BASE-2

BNC, ThinNet



Guard legacy Ethernet data lines—especially the long cable runs used for routers and bridges—from transient surges that can be caused by nearby lightning, AC motors, appliances or even the normal operation of UPS devices. Let our coax Ethernet protectors shield your LAN from costly downtime due to surges.

- ✓ Available for ThinNet ("thin" coax) and ThickNet ("thick" coax) Ethernet
- ✓ Highly sensitive avalanche-diode circuitry
- ✓ Low signal loss
- ✓ Install quickly and easily
- ✓ Miniature size

Model 531
Page 235

10BASE-5

N-Type, ThickNet



Model 530
Page 235

AUI

IEEE 802.3 Compliant



Let our AUI Ethernet protectors shield your LAN from costly downtime due to surges.

- ✓ Complies with the IEEE 802.3 Specification
- ✓ Highly sensitive avalanche-diode circuitry
- ✓ Install quickly and easily

Model 534
Page 236

TOKEN RING

IEEE 802.5 Compliant



These surge protectors guard 802.5 networks against data loss & hardware damage caused by data line transients. Protects repeaters, MAUs, & other Token Ring devices

- ✓ Protection for 4 Mbps or 16 Mbps Token Ring Networks
- ✓ Surge handling capacity of 1,500 watts
- ✓ Available with RJ-45, DB-9, & IBM data connectors

Models 535/6/7
Page 236

Surge Protection

230

Async DB-25 Surge Protectors	232
Async DB-25 Low Capacitance Surge Protector ..	232
Sync DB-25 Surge Protector	232
Sync DB-9 Surge Protector	232
Sync DB-15 Surge Protector	232
Serial DB-25 Surge Protector (All 25 Leads) ...	232
RJ-11 Surge Protector	233
RJ-12 Surge Protector	233
RJ-45 Surge Protectors	233
Parallel Surge Protectors	233
10/100Base-T (Cat-5) Secondary Surge Protector	234
10/100Base-T (Cat-5) Secondary Multiport Protectors	234
Multiport RS-232 & RS-422 Surge Protectors ...	235
Coax Ethernet Surge Protectors	235
Ethernet AUI Surge Protector (DB-15)	236
802.5 Token Ring Surge Protectors	236
Twinax Surge Protectors for IBM AS/400	236
Video Surge Protectors	236
Async RS-232-to-RS-232 Optical Isolators	237
Async RS-422/485 Optical Isolators	237
V.35 (M/34) Surge Protector	237
Telco Surge Protectors	238
Terminal Strip Surge Protector	239

Multiport Protection

10/100BASE-TX

Up to 100 Mbps
(PoE 802.3af available)



Contains up to 8 10/100Base-TX protectors per enclosure

Models 57X & 58X
Page 234

10/100BASE-TX (CATEGORY-5)

Up to 100 Mbps
(PoE 802.3af available)



Protects 8 or 16-port Category-5 interfaces (including RS-422, RS-423, 10/100Base-TX, Token Ring, Fast Ethernet, and ATM) twisted-pair hubs against transients

Models 570R & 580R
Page 234

Async DB-25 Surge Protectors

Models 500 & 501

**FEATURES & BENEFITS**

- ✓ Model 500 protects pins 2, 3, 7 and 20 (pin 1 and shell connected to ground)
- ✓ Model 501 protects pins 2, 3, 4, 5, 6, 7, 8 and 20 (pin 1 and shell connected to ground)

ORDERING INFORMATION

500: Async DB-25 Surge Protector

501: Async DB-25 Surge Protector

Async DB-25 Low Capacitance Surge Protector

Model 501LC

**FEATURES & BENEFITS**

- ✓ Get maximum distance from long runs
- ✓ Protects pins 2–8, 11, 20, 22, 24 & 25
- ✓ Adds an insignificant 45 pF of capacitance to each signal

ORDERING INFORMATION

501LC: Async DB-25 Surge Protector, Low Capacitance

Sync DB-25 Surge Protector

Model 502

**FEATURES & BENEFITS**

- ✓ Protects pins 2–8, 15, 17, 22 & 24
- ✓ Diverts surge energy to pin 1 and D-shell at both ends

ORDERING INFORMATION

502: Sync DB-25 Surge Protector

Sync DB-9 Surge Protector

Model 509

**FEATURES & BENEFITS**

- ✓ Two clamping voltages: 7.5 V (RS-422) or 18V (EIA-574/RS-232)
- ✓ Combined surge-handling of 5,400 watts
- ✓ Protects all 9 pins

ORDERING INFORMATION

509/6: DB-9 Surge Protector (for RS-422/485)

509/25: DB-9 Surge Protector (for RS-232)

Sync DB-15 Surge Protector

Model 515

**FEATURES & BENEFITS**

- ✓ Support for data rates up to 20 Mbps
- ✓ Clamping voltages for RS-232 (18V), RS-422, 485, X.21, T1 (7.5V)
- ✓ 515/6 & 515/25 protect all 15 wires
- ✓ 515/T1 protects pins 1, 3, 9, and 11

ORDERING INFORMATION

515/6: DB-15 Surge Protector (for RS-422/485)

515/25: DB-15 Surge Protector (for RS-232)

515/T1: DB-15 Surge Protector

Serial DB-25 Surge Protector (All 25 Leads)

Model 503S



This universal surge protector guards any RS-232 system (synchronous or asynchronous) against data loss and hardware damage caused by data line tran-

sients. There are many sources of such transients—lighting strikes, fluorescent lights, elevator motors, even UPSs. AC protection alone is not enough! The Model 503S diverts harmful data line surges to chassis ground (through either D-shell) before they reach your hardware.

FEATURES & BENEFITS

- ✓ Protects all 25 serial pins on the DB-25 connector
- ✓ Combined surge handling capacity of 36,000 watts
- ✓ Diverts surges safely to chassis ground through D-shell connectors

ORDERING INFORMATION

503S: RS-232 Serial DB-25 Surge Protector

503S/6: RS-422/485 Serial DB-25 Surge Protector

RJ-11, RJ-12, & RJ-45 Surge Protectors

Models 510, 511 & 512

The Models 510, 511 and 512 surge protectors let you choose 4, 6 or 8 wire protection for either an RS-232 or RS-422 modular interface. These ultraminiature protectors fit almost anywhere and handle transient surge up to 600 watts per wire. Harmful surge energy is diverted safely to chassis ground using a built-in braided metal strap. Should these protectors encounter a severe surge above their rated capacity, they will divert all voltages to ground.



FEATURES & BENEFITS

- ✓ **Model 510** protects four wires on the RJ-11 connector (combined surge handling of 2400 W)
- ✓ **Model 511** protects six wires on the RJ-12 connector (combined surge handling of 3600 W)
- ✓ **Model 512** protects eight wires on the RJ-45 connector (combined surge handling of 4800 W)
- ✓ Heavy braided ground strap diverts surge energy to frame ground
- ✓ Clamping at 18 volts for RS-232 and 7.5 volts for RS-422
- ✓ "Fail-safe" design guards hardware in case of severe surge

Model 512 application diagram



Parallel Surge Protectors

Models 503P & 503PC

When protecting your computer's data lines from transient surge, don't forget the parallel ports: The relatively low voltages of parallel signals make them surge-sensitive! The Patton Model 503P connects directly to a PC's parallel port and guards all 25 pins of the DB-25 interface. The Patton Model 503PC connects directly to a printer's parallel port and guards all 34 pins of the Centronics® interface. Both models handle repeated surges up to 1500 kW.

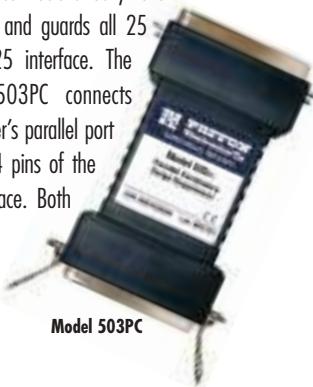

Model 503PC

FEATURES & BENEFITS

- ✓ **Model 503P** protects all 25 pins on the DB-25 parallel interface
- ✓ **Model 503PC** protects 34 pins on the Centronics® parallel interface
- ✓ Surge energy diverted to chassis ground through connector shells
- ✓ 1.5 kw (503PC) surge handling capacity
- ✓ 503PC clamps at +8V -3V; 503P clamps at 6.8 V
- ✓ Quick response time of 500 nsec



Model 503P

Model 503P & 503PC application diagram



ORDERING INFORMATION

Model 510

510/6: 4 line modular surge protector (RS-422, 6V clamping)

510/25: 4 line modular surge protector (RS-232, 25V clamping)

Model 511

511/6: 6 line modular surge protector (RS-422, 6V clamping)

511/25: 6 line modular surge protector (RS-232, 25V clamping)

Model 512

512/6: 8 line modular surge protector (RS-422, 6V clamping)

512/25: 8 line modular surge protector (RS-232, 25V clamping)

IMPORTANT

When ordering a Model 510, 511 or 512, please provide us with the following information:

- Whether your application is 4-wire (RJ-11), 6-wire (RJ-12) or 8-wire (RJ-45)
- Whether your application is RS-232 (clamps at 18V) or RS-422 (clamps at 7.5V)

Model 503 & 503PC

503PC: Centronics® 36-Pin Parallel Surge Protector

503P: DB-25 Parallel Surge Protector

I'm Bob, one of Patton's Support Engineers. If you do not find what you need at www.patton.com or in this catalog, or if you have technical questions or comments, please call me at +1 301.975.1007. You can also send e-mail to puckett@patton.com.



10/100Base-TX (Cat-5) Secondary Surge Protector**Models 570, 580, & 570-POE, 580-POE***Our Cat-5 protector works at speeds up to 100 Mbps*

These 10/100Base-TX surge protectors are EIA/TIA TSB-40A Category-5 certified, and can protect your RS-422/423, Token Ring, and ATM equipment too! With a NEXT spec of -43dB (worst pair), you can rest assured that these units will protect your 10/100Base-TX, RS-422 or 100VG-AnyLan data lines without hindering critical network performance. The Model

570 is designed for use at the sensitive equipment port, while the Model 580 protects barriers (such as wiring closets).

**SPECIFICATIONS**

Environment: Category-5 Interfaces that use the RJ-45 connector, including RS-422/423, 10Base-T, Token Ring, 100Base-TX & ATM

Connectors: RJ-45 Female

Response Time: Clamped to 13 V after 0.1 μ s

Surge Clamp Voltage: Model 570—13 V max with 1 kV Input; Model 580—15 V max with 2 kV Input

NEXT Loss: Model 570—worst pair Better than -46 dB at 100 MHz; Model

580—worst pair Better than -43 dB at 100 MHz

Characteristic Impedance: 100 ohm

Surge Rating: IEC 801.5 Standard Level

DC Clamp Voltage: Common Mode to Gnd, each line 7.5 V @ 50 mA; Differential mode, per pair 8.1 V @ 50 mA

Insertion Loss: Less than 0.4 dB at 100 MHz (including connector)

Return Loss: Better than 14 dB

Group Delay: None, 1–100 MHz
Series Resistance: Less than 400 milli-ohms

Grounding: External ground strap provides separate unit-ground to chassis-ground

Dimensions: 2.25 x 1.89 x 0.75 in (5.72 x 4.29 x 1.91 cm)

570 & 580

Common mode (to ground) (each line): 7.7 V @ 10mA (pulse)

Differential mode (per pair): 8.6 V @ 10 mA (pulse)

570-POE & 580-POE

Pairs (1, 2) & (3, 6)

Common mode (to ground) (each line): 7.7 V @ 10mA (pulse)
Differential mode (per pair): 8.6 V @ 10 mA (pulse)

Pairs (4, 5) & (7, 8)

Common mode clamping voltage is 69 V @ 1 mA (pulse transient) and Differential mode clamping voltage is 70 V @ 1mA (pulse transient).

FEATURES & BENEFITS

- ✓ EIA/TIA TSB-40A Category-5 certified
- ✓ Models for use at the equipment (570) or barriers/wiring closets (580)
- ✓ Near-end cross-talk (NEXT) better than -43 db for transparent protection
- ✓ Complies with transient immunity standards IEC 801-2, 801-4, & 801-5
- ✓ Response time of 0.1 μ s
- ✓ 802.3af compliant models available

ORDERING INFORMATION

570: 10/100Base-T (CAT-5) Protector Point of Use (8-Wire)

570-POE: 10/100Base-T PoE Protector Point of Use

580: 10/100Base-T (CAT-5) Protector Barrier (8-Wire)

580-POE: 10/100Base-T PoE Protector Barrier

10/100Base-TX (Cat-5) Secondary Multiport Protectors, Hub and Panel (Rack Mount) Formats**Models 57X & 58X***Our Cat-5 protector works at speeds up to 100 Mbps.*

The Model 57X and 58X Series Category-5 hub protectors are available in 4, 6 or 8-port standalone versions, as well as 8 or 16-port rack mount panels. All Model 57X and 58X units are EIA/TIA TSB-40A Category-5 certified, and divert harmful data line transients to chassis ground through a single braided metal strap. This approach reduces the number of ground connections required. Specifications like near-end cross-talk



(NEXT) of better than -43 dB at 100MHz, as well as insertion loss of less than 0.4 dB, insure transparent operation.

FEATURES & BENEFITS

- ✓ Provides 4, 6, 8 or 16 ports of protection against transients
- ✓ Guards twisted-pair interfaces at speeds up to 100 Mbps
- ✓ EIA/TIA TSB-40A Category-5 Certified
- ✓ Models for Point-of-Use (57X) or Barriers/Wiring Closets (58X)

SPECIFICATIONS

Connectors: RJ-45 Female

Response Time: Less than 5 ns

Characteristic Impedance: 100 ohm

NEXT Loss: Better than -43 dB at 100 MHz

Surge Clamp Voltage: Model 57X—13 V max with 1 kV Input; Model 58X—15 V max with 2 kV Input

Surge Rating: IEC 801.5 Standard Level

DC Clamp Voltage: Common Mode to Gnd, each line 7.5 V @ 50 mA;

Differential mode, per pair 8.1 V @ 50 mA

Return Loss: Better than 14 dB

Insertion Loss: Less than 0.4 dB (including connector) at all frequencies

Series Resistance: Less than 400 milli-ohms

Grounding: External ground strap through mounting screws

ORDERING INFORMATION

574: 4-Port, 10/100Base-TX (CAT-5) Hub Protector Point for Use

576: 6-Port, 10/100Base-TX (CAT-5) Hub Protector Point for Use

578: 8-Port, 10/100Base-TX (CAT-5) Hub Protector Point for Use

570R8: 8-Port 10/100Base-TX (CAT-5) Panel Protector Point for Use

Call for 802.3af PoE versions.

570R16: 16-Port 10/100Base-TX (CAT-5) Panel Protector Point for Use

584: 4-Port 10/100Base-TX (CAT-5) Hub Protector for Wiring Closets

586: 6-Port 10/100Base-TX (CAT-5) Hub Protector for Wiring Closets

588: 8-Port 10/100Base-TX (CAT-5) Hub Protector for Wiring Closets

580R8: 8-Port 10/100Base-TX (CAT-5) Panel Protector for Wiring Closets

580R16: 16-Port 10/100Base-TX (CAT-5) Panel Protector for Wiring Closets

Multiport RS-232 & RS-422 Surge Protectors

Model 51X Series

The Model 51X Series is a convenient way to provide data line surge protection for hosts, terminal servers, or other multiport devices. Guarding either RS-232 or RS-422/485 equipment, the Model 51X Series houses 4, 6, 8 or 12 surge protectors in a high density array. A choice of two different clamping voltages—11 volts for RS-422/485 devices or 27 volts for RS-232 devices—assures you of an unimpeded data flow. Matching RJ-45 input/output ports on the front and rear panels allow the Model 51X Series to connect conveniently in-line with each port on your device. All versions of the Model 51X Series support data rates up to 230 kbps. Harmful data line transients are intercepted before



they reach equipment ports and are diverted safely to chassis ground. Employing a solid state hybrid circuit, the Model 51X Series is able to handle repeated surges up to 1.5 kWatts. One 6-inch (15.2 cm) patch cable is included for each port on the unit.

Typical application



FEATURES & BENEFITS

- ✓ Four Port Densities Available: 4, 6, 8 or 12 Modular Ports per Enclosure
- ✓ Two Clamping Voltages: 11 Volts (RS-422/485) or 27 Volts (RS-232)
- ✓ Data Rates up to 230 kbps
- ✓ 1.5 kW of Surge Handling Capability
- ✓ Surge Energy Diverted to Ground through Braided Metal Strap

ORDERING INFORMATION

RS-232 Surge Protector

514/25: 4-Port Modular

516/25: 6-Port Modular

518/25: 8-Port Modular

513/25: 12-Port Modular

RS-422/485 Surge Protector

514/6: 4-Port Modular

516/6: 6-Port Modular

518/6: 8-Port Modular

513/6: 12-Port Modular

Coax Ethernet Surge Protectors

Models 530 & 531

Transient surges can be caused by nearby lightning, AC motors, appliances or even the normal operation of UPS devices. Let our coax Ethernet protectors guard your LAN from costly downtime due to surges.



FEATURES & BENEFITS

- ✓ Novell approved for NetWare versions 2.2 and 3.11 (Model 530)
- ✓ Meets the IEEE 802.3 specification
- ✓ Combined surge handling of 3 kW
- ✓ Direct connection to network interface cards and other LAN hardware
- ✓ "T" model replaces existing T-splitter
- ✓ Diverts surges safely to chassis ground via braided metal strap

ORDERING INFORMATION

Model 530

530 MF: Thick Ethernet Surge Protector, (N-Type, Male to Female)

Model 531

531 MF: Thin Ethernet Surge Protector, (BNC, Male to Female)

531 MFF: Thin Ethernet Surge Protector, (BNC, T-Splitter, Male, Female, Female)

SPECIFICATIONS

Connectors: N-type coaxial
Response Time: Less than 5 ns
Input Capacitance: 18 pF
Clamp Voltage: 25 V at 100 A (8/20 μ s waveform)
Surge Current: 400 A (8/20 μ s waveform)
Energy Handling: 1,500 watts per wire

Transfer Loss: -0.65 dB at 100 MHz
Group Relay: None, 1 MHz to 100 MHz
Dimensions: 2 in. L x 1 in. dia.
Op. Temp.: -67 to 212°F (-55 to 100°C)

visit us online
www.patton.com

FAST Delivery From Your AUTHORIZED DISTRIBUTOR!

PATTON
Electronics Co.

Ethernet AUI Surge Protector (DB-15)
Model 534

Gives workstations and hubs the upper hand against transients

The Model 534 connects directly to DB-15 AUI ports on interface cards, hubs and repeaters. Protecting DB-15 pins 1 thru 6, 8, 9, 11, 12, 13 and 14 (pins 1, 4, 8, 11 and 14 are electrically connected on both ends), the Model 534 intercepts transient voltages and sends them safely to ground through both DB-15 connector shells.

FEATURES & BENEFITS

- ✓ Meets the IEEE 802.3 specification
- ✓ Combined surge handling capacity of 7,200 watts

ORDERING INFORMATION

Ethernet AUI Surge Protector
 534 MF: DB-15 (Male to Female)

802.5 Token Ring Surge Protectors
Models 535, 536, & 537

Whatever your Token Ring topology, we have the right data line protector for you!

Token Ring surge protectors guard 802.5 networks against data loss and hardware damage caused by data line transients. Sophisticated solid data circuits allow our Token Ring protectors to protect transparently—while shielding your devices from surge hit after surge hit.

FEATURES & BENEFITS

- ✓ IEEE 802.5 compliant
- ✓ Protection for 4 Mbps or 16 Mbps Token Ring networks

ORDERING INFORMATION

Type 1 Token Ring Surge Protector
 535 MF: DB-9 (Male to Female)

Type 3 Token Ring Surge Protector
 536 FF: UTP, RJ-45 (Female to Female)

536S FF: STP, RJ-45 (Female to Female)

Type B Token Ring Surge Protector
 537: IBM Data Connector

Twinax Surge Protector for IBM AS/400
Model 545

Reliable data line protection for midrange systems

The Model 545 greatly reduces the threat that transient surges pose to twinax networks. Installing directly between incoming twinax data cables and twinax data ports, the Model 545 safely diverts surge energy to chassis ground before hardware damage occurs. Our T-splitter version replaces the twinax T-splitter on your existing connection.

FEATURES & BENEFITS

- ✓ 3,000 watts energy handling
- ✓ In-line (MF, FF) or T-splitter (MFF) configurations available

ORDERING INFORMATION

AS/400 Surge Protector
 545MF: Twinax, male to female

545FF: Twinax, female to female

545MFF: Twinax "T" male, female, female

Video Surge Protectors
Models 542 & 543

The Model 542 and 543 video surge protectors connect in-line between the coax video cable and the connection port on your camera, console, or other video equipment. Transient surges are intercepted and diverted to ground through a braided metal strap. The video protectors can handle repeated surges up to 1,500 watts per wire. Their "fail safe" design protects your video equipment even in the event of a severe surge.

FEATURES & BENEFITS

- ✓ 3,000 watts energy handling
- ✓ In-line (MF, FF) or T-splitter (MFF) configurations available

ORDERING INFORMATION

542: CCTV (BNC)

543: SATV, VSAT, DirecTV (F-Type)

Asynchronous RS-232 Optical Isolators

Model 590 Series

Don't let ground loops disrupt your RS-232 communications!

The Model 590 Series of RS-232 optical isolators guard your asynchronous equipment from the hazards of ground looping. Plugging directly into your DTE hardware, the Model 590 Series provides 2500V RMS peak DCE/DTE isolation. Both the Model 590A (19.2 kbps max) and Model 591A (115.2 kbps max) isolate 4 lines on the RS-232 interface—two of

which are selectable by internal jumpers. The Model 592 (19.2 kbps max) and Model 594 (115.2 kbps max) isolate 7 pre-wired lines on the RS-232 interface.



SPECIFICATIONS

Transmission Format:

Asynchronous, full or half duplex

Interface Standard: EIA RS-232E

Connectors: DB-25 female on DCE side (direct connection to DTE equipment); DB-25 male on DTE side (connects by cable to DCE equipment)

Data Rates: Model 590A/592—0 to 19.2 kbps; Model 591A/594—0 to 115.2 kbps

Lines Isolated: Model 590A/591A—TD (2), RD (3), DTR (20) or RTS (4); CD (8), DSR (6) or CTS (5). Model 592/594—TD (2), RD (3), RTS (4), CTS (5), DSR (6), CD (8) and DTR (20).

Power Supply: Model

590A/591A—RS-232 Interface powered, or user-supplied 12V DC input on pin 9 of the DCE interface (45mA); Model 592/594—External AC transformer

Isolation: 2500V RMS peak isolation
Dimensions: 3.8 x 2.1 x 0.79 in. (9.7 x 5.3 x 2.0 cm)

Op. Temp.: 32–122°F (0–50°C)

Altitude: 0–10,000 feet (0–3,078 m)

Humidity: Up to 95% non-condensing

FEATURES & BENEFITS

- ✓ 2500V RMS peak isolation
- ✓ Models 590A and 592 support async data rates to 19.2 kbps
- ✓ Models 591A and 594 support async data rates to 115.2 kbps

ORDERING INFORMATION

RS-232 Optical Isolator (DB-25M to DB-25F)
590AF: 19.2 kbps, 4 Lines Isolated

591AF: 115.2 kbps, 4 Lines Isolated

592/25F: 19.2 kbps, 7 Lines Isolated 120 V

594/25F: 115.2 kbps, 7 Lines Isolated, 120 V

230 VAC version also available, call for details.

RS-422/485 Optical Isolators

Model 593 Series

Prevent the early failure of your RS-422/485 devices!

The Model 593 series of RS-422/485 optical isolators protects your RS-422/485 equipment from the hazards of ground looping. Connect the Model 593 directly to your equipment via a DB-25 or RJ-45 connector, or a terminal block. The Model 593 supports data rates up to 115.2 kbps.



SPECIFICATIONS

Transmission Format:

Asynchronous, full- or half-duplex

Interface standard: RS-422/485, or terminal block

Data rates: Up to 115.2 kbps

Power Supply: AC external power supply

Isolation: 2500 Vrms peak isolation
Op. Temp.: 32–140°F (0–60°C)

Altitude: 0–10,000 ft (3,048 m)

Dimensions:

593/45 & 593/TB:
3.8L x 2.1W x 0.79H in.
(9.7L x 5.3W x 2.0H cm)

593/25:

4.1L x 2.1W x 0.79H in.
(10.4L x 5.3W x 2.0H cm)

Humidity: 5–95% non-condensing

FEATURES & BENEFITS

- ✓ 2500 Vrms peak isolation
- ✓ Supports asynchronous data rates up to 115.2 kbps

ORDERING INFORMATION

RS-422/485 Optical Isolator

593/45: RJ-45F to RJ-45F, 115.2 kbps 4 lines isolated

593/25F: DB-25F to DB-25F, 115.2 kbps 4 lines isolated

593/TB: Terminal block to terminal block, 115.2 kbps, 4 lines isolated

V.35 (M/34) Surge Protector

Model 546

Compact unit that plugs directly into your M/34 interface—no expensive adapter cables!

The Model 546 surge protector guards V.35 data ports against damage and data loss due to transient surges. It intercepts harmful surges and diverts them to chassis ground through a braided metal strap. All standard data, clocking and control signals on the CCITT V.35 interface are protected (although the Model 546 is also available with all 34 pins protected).



FEATURES & BENEFITS

- ✓ Surge handling capacity of 1,500 watts
- ✓ Supports data rates up to 20 Mbps
- ✓ Able to handle repeated surges without degrading in performance

ORDERING INFORMATION

546MF: V.35 Surge Protector (Standard Lines) M/34 (Male to Female)

546/34MF: V.35 Surge Protector (All 34 Lines) M/34 (Male to Female)

Telco Line Surge Protectors

Model 552 Series

Guard All Your Telco Lines: T1, ISDN, DDS, Leased & Dial-up!

Your telco lines are a vital data link with the outside world. But they can also carry some very undesirable transient spikes into your data ports! The Patton Model 552 installs between an incoming telco line and a dial-up/leased line modem, ISDN modem (a.k.a. TA, NTU), T1/E1/PRI or DDS CSU/DSU or other termination hardware to intercept and divert telco line transients.



THE PART NUMBER TELLS YOU THE APPLICATION:

Model 552-D2: For protection of 2-wire dial-line modems, faxes, phones.

Pins Protected: Pins 4 and 5 on the RJ-45 Interface (RJ-11 Pins 3 and 4 via 6 in./15 cm patch cable)

Protection Mode: Common Mode Pins 4, 5 to shielding braid; Differential Mode Pins 4, 5.

Model 552-D4: For protection of 4-wire dial-line modems, faxes, phones.

Pins Protected: Pins 3, 4, 5, 6 on the RJ-45 Interface (RJ-11 Pins 3, 4, 5, 6 via 6 in./15 cm patch cable)

Protection Mode: Common Mode Pins 3, 4, 5, 6 to shielding braid; Differential Mode Pins 3, 4, 5, 6.

Model 552-L4 : For protection of 4-wire leased line modems.

Pins Protected: Pins 3, 4, 5, 6 on the RJ-45 Interface; (RJ-11 Pins 2, 3, 4, 5 via 6 in./15 cm patch cable)

Protection Mode: All pins Common Mode to shielding braid; Differential 3 and 6, 4 and 5.

Model 552-DDS: For protection of 56/64K CSU/DSU products.

Pins Protected: Pins 1, 2, 7, 8;

Protection Mode: Common Mode Pins 1, 2, 7, 8 to shielding braid; Differential Mode Pins 1, 2, 7, 8

Model 552-T1& E1: For protection of T1& E1 CSU/DSUs and Multiplexers.

Pins Protected: Pins 1, 2, 4, 5

Protection Mode: Common Mode Pins 1, 2, 4, 5 to shielding braid; Differential Mode Pins 1, 2, 4, 5.

Model 552-E1CX: For protection of all shields and center pins.

Pins Protected: All shields and center pins

Protection Mode: Common Mode Center Pins and Shield to

shielding braids. Differential Mode Center Pins to Shields

Model 552-U: For protection of ISDN TAs and NTUs.

Pins Protected: Pins 3, 4, 5, 6;

Protection Mode: All pins Common Mode to shielding braid; Differential 3 and 6, 4 and 5.

Model 552-ST: For protection of ISDN TAs and NTUs.

Pins Protected: All 8 pins on the RJ-45 interface;

Protection Mode: All pins Common Mode to shielding braid Differential Mode Pins 1 and 2, 7 and 8; Differential Mode Pins 3 and 6, 4 and 5.

FEATURES & BENEFITS

- ✓ Seven versions custom tailored to specific Telco interfaces!
- ✓ Safety tested and listed under UL 497A specification for secondary surge protectors
- ✓ Surge handling capacity of 1500 W
- ✓ Surge energy diverted to ground through braided metal strap
- ✓ "Fail-safe" design protects equipment in case of overload
- ✓ 6-in. (15.24 cm) modular cable included



I'm John, one of Patton's Micro Products Group Managers. If you do not find what you need at www.patton.com or in this catalog please call me at +1 301.975.1000, x160. You can also send e-mail to igrant@patton.com.

SPECIFICATIONS

Series resistance: 0.340 ohms
In-line fuse rating: 250V, 0.75 amp, 2.95 (A² sec) nominal melting point
Approvals: UL497A Telco Specification (except E1 versions)
Connectors: Two female RJ-45 or 4 BNC jacks (552-E1CX)

Dimensions: 3L x 0.75H x 2.1W in. (7.62L x 1.9H x 5.3W cm)
Weight: 0.1 lbs (0.045 kg)

ORDERING INFORMATION

- 552-D2:** 2-Wire Dial Up Protector (RJ-11 pins 3 & 4)
- 552-D4:** Dual 2-Wire Dial-Up Protector (RJ-11 pins 2, 3, 4 & 5)
- 552-L4:** 4-Wire Leased Line Protector (RJ-45 pins 3, 4, 5 & 6)
- 552-DDS:** 4-Wire DDS Protector (RJ-45 pins 1, 2, 7 & 8)
- 552-T1:** 4-Wire T1 & ISDN PRI Protector (RJ-45 pins 1, 2, 4 & 5)
- 552-E1:** 4-Wire E1 & ISDN PRI Protector (RJ-45 pins 3, 4, 5 & 6)
- 552-E1CX:** Dual Coax E1 Protector
- 552-U:** 4-Wire ISDN Protector—U Type (RJ-45 pins 3, 4, 5 & 6)
- 552-ST:** 8-Wire ISDN Protector—ST Type (All 8 pins on the RJ-45)

Terminal Strip Surge Protectors

Model 52X Series

Create the surge protector you need for just about any interface.



Design Your Own Protector

The Patton 52X Series lets you design your own "custom" surge protector to fit just about any 2, 4, 6, 8 or 10 wire application. You specify the number of lines you need protected. You specify the clamping voltage that is optimum for your application. Each surge protector comes with input/output terminal strips and strain relief straps to hold the wires.

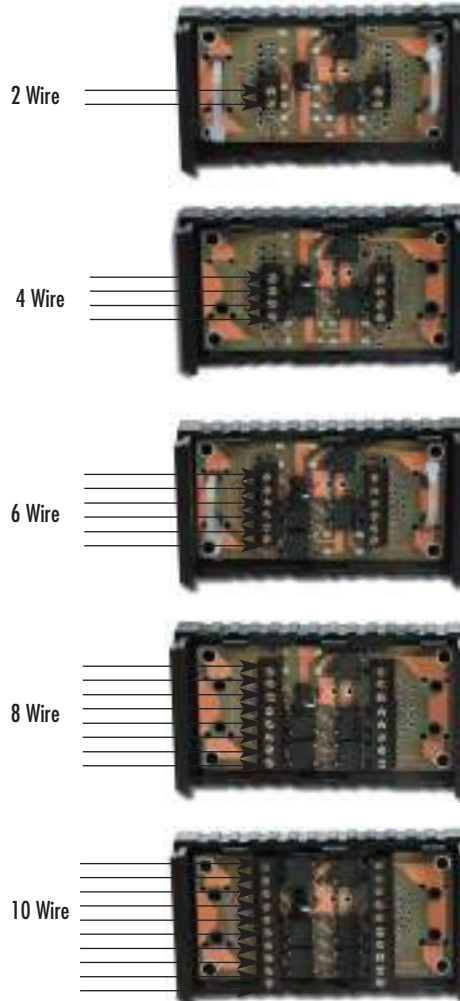

FEATURES & BENEFITS

- ✓ Clamping voltages for RS-232, RS-422, RS-485, Token Ring or Ethernet (call for custom options)
- ✓ Strain relief straps hold wires firmly in place
- ✓ Surge handling capacity of 1,500 watts
- ✓ Surge energy diverted to ground through braided metal strap
- ✓ You choose the number of lines to protect for your application

SPECIFICATIONS

Interface: RS-232, RS-422/485, Ethernet, Token Ring
Connectors: Terminal Strip
Wires Protected: 2, 4, 6, 8 or 10
Surge Capacity: 400A (8/20 μS)
Clamp Voltage: Residual surge† at 2 kV (1.2/50μS), 1 kA (8/20μS wave form [105 volts])
Maximum Speed: 20 Mbps
Construction: UL94-5V rated flame-retardant plastic

Dimensions: 3.0 x 1.67 x 0.8 in. (7.62 x 4.24 x 2.03 cm)
Humidity: 5–95%, non-condensing
Op. Temp.: -40 to +185°F (-40 to +85°C)
Dimensions: 3L x 0.75H x 2.1W in. (7.62L x 1.9H x 5.3W cm)
Weight: 0.1 lbs (0.045 kg)

†Residual surge is a special term defined by the IEEE and NEMA to replace the term *clamp voltage*.



ORDERING INFORMATION

Terminal Strip

- 522/25-TS: 2-Wire, 19.2 V
- 524/25-TS: 4-Wire, 19.2 V
- 526/25-TS: 6-Wire, 19.2 V
- 528/25-TS: 8-Wire, 19.2 V
- 521/25-TS: 10-Wire, 19.2 V
- 522/6-TS: 2-Wire, 8.7 V
- 524/6-TS: 4-Wire, 8.7 V
- 526/6-TS: 6-Wire, 8.7 V
- 528/6-TS: 8-Wire, 8.7 V
- 521/6-TS: 10-Wire, 8.7 V



DB-25 & DB-9 Data Taps

Models 3 & 3/9

Monitor data line activity or connect 2 devices to one RS-232 port! Models 3 and 3/9 provide a simple, inexpensive way to "tap" into a data line so you can use a scope or monitor to see what is occurring without interrupting the flow of data. Three DB-25 (Model 3) or DB-9 (Model 3/9) connectors—wired straight through—make tapping into existing RS-232 lines simple and neat. These handy little devices can also be used anywhere you would use a "Y" cable, such as connecting 2 terminals in parallel to one port. Please specify gender: MF—M, MF—F, MM—M, MM—F, FF—M, or FF—F.

FEATURES & BENEFITS

- ✓ All pins wired straight through to all three connectors
- ✓ A great way to monitor data line activity or connect two devices to one RS-232 port
- ✓ Available in all gender combinations

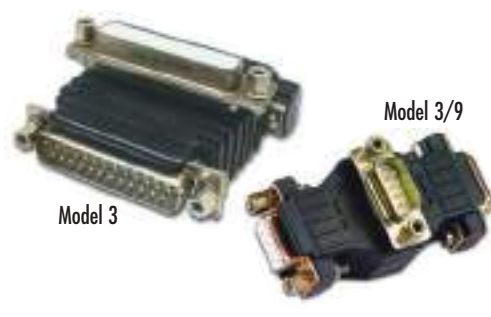

ORDERING INFORMATION

Model 3
3XY-Z: DB-25 Data Tap (specify genders)

Model 3/9
3/9XY-Z: DB-9 Data Tap (specify genders)

Model 3/9HDX
3/9HDXY-Z: DB-9 Data Tap (Half-Duplex) (specify genders)

Example:
3/9 FM-F
X= (M) Male or (F) Female
Y= (M) Male or (F) Female
Z= (M) Male or (F) Female



Model 3/11
3/11: Data Tap with 3 RJ-11 connectors

Model 3/34
3/34MF-F: M/34 (V.35 Data Tap)
3/34MM-F: M/34 (V.35 Data Tap)

Model 3/45
3/45: Data Tap with 3 RJ-45 connectors

Model 3P-MF
3P-MF: DB-15 Modem Power Supply Adapter Supplies 9 VDC
3PMF9: DB-9 Modem Power Supply Adapter, Supplies 9 VDC

Note: More models are available, call for details.

DB-9 Data Tap (Half-Duplex)

Model 3/9HDX



FEATURES & BENEFITS

- ✓ Allows EIA-574/RS-232 Monitoring
- ✓ Top Connector Side OR Gate Allows Monitoring of TD and RD Lines in a Half-Duplex Environment
- ✓ Data Rates to 115.2 kbps

Telco Data Taps for T1, E1, or DDS

Models 3/11 & 3/45



FEATURES & BENEFITS

- ✓ A great way to tap into and monitor DDS, T1, E1 or other WAN circuits.
- ✓ All 6 or 8 pins are wired straight through to all 3 connectors
- ✓ Terminating resistors prevent the tap device from interfering with normal circuit operation.

M/34 (V.35) Data Tap

Model 3/34



FEATURES & BENEFITS

- ✓ All 34 pins wired straight through to all three connectors
- ✓ Make a V.35 "Y" cable, or tap into a network connection
- ✓ Available in all gender combinations

Power Supply Adapters

Models 3P-MF & 3PMF9



FEATURES & BENEFITS

- ✓ Provides power to any Patton self-powered short-range modem
- ✓ Plug-in DB-25 or DB-9 modules
- ✓ 120 or 230 VAC version available
- ✓ Supplies 9 VDC power

I'm Dave, Patton's Manager of US Technical Support. If you do not find what you need at www.patton.com or in this catalog, or if you have technical questions or comments, please call me at +1 301.975.1007. You can also send e-mail to puckett@patton.com.



Modular to Modular Adapter

Model 7



FEATURES & BENEFITS

- ✓ Go from RJ-11 to RJ-11 (Model 7A)
- ✓ Go from RJ-45 to RJ-45 (Model 7B)
- ✓ Go from RJ-11 to RJ-45 (Model 7C)
- ✓ Comes in a kit you can wire yourself

RS-232 Interface Connector

Model 80



FEATURES & BENEFITS

- ✓ Matches all async, RS-232 data, handshake and control lines
- ✓ Interface powered (no AC or batteries)
- ✓ Data rates to 19.2 kbps
- ✓ Model 80 uses straight cables; Model 80C comes with 3 ft (0.91 m) ribbon cables

Pin 2-3 Reverser

Model 5



FEATURES & BENEFITS

- ✓ Connect two RS-232 DTEs or DCEs
- ✓ Pins 2 and 3 “crossed over” (all other DB-25 pins passed straight through)
- ✓ All gender combinations available (MF, FF, MM)

Loopback Adapter

Model 6L



FEATURES & BENEFITS

- ✓ Loops back DB-25 Pins 2 & 3, 4 & 5, 6, 8 & 20 on both ends
- ✓ The easy way to produce a “local echo” for testing RS-232 devices
- ✓ One male, one female connector

Async Null Modem Adapters

Models 6A, 6B, & 6C

Data Terminals don't want to “talk” to each other! Neither do Personal Computers or serial printers! They will only talk to modems (DCEs), not to each other (DTEs). But these devices can be “fooled” into thinking they are connected to “modems” when they are not. Our null modem adapters (also called async modem eliminators or cross over cables) will do the job.



FEATURES & BENEFITS

- ✓ **Model 6A**—No Handshake: This is the most frequently used arrangement
- ✓ **Model 6B**—Standard Handshake: This connection allows for the most common hardware flow control
- ✓ **Model 6C**—Full Handshake: This model is for full query and response between two RS-232C devices

ORDERING INFORMATION

Model 7

7AXXK: From RJ-11 to RJ-11 solder kit

7BXXK: From RJ-45 to RJ-45 solder kit

7CXXK: From RJ-11 to RJ-45 solder kit

XX = Specify genders. K = Kit.

Model 80

80: MagiConnector™ (unit only)

80C: MagiCable™ (with 3 ft/0.91 m cables)

Model 5

5: Pin 2-3 Reverser

Specify genders

Model 6L

6L: Loopback Adapter

Model 6, Null Modem Adapter

6AXX: No Handshake

6BXX: Standard Handshake

6CXX: Full Handshake

XX = Specify genders.

Note: More models are available, call for details.

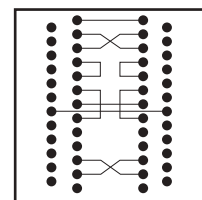

Model 6A
No Handshake

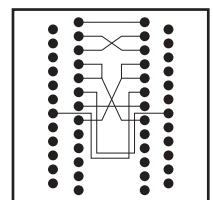

Model 6B
Standard Handshake

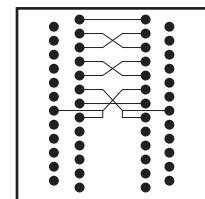

Model 6C
Full Handshake



DB-25 to Modular Adapters

Models 11 & 12



FEATURES & BENEFITS

- ✓ DB-25 (Male or Female) to RJ-11/RJ-12, RJ-45, or Dual RJ-11/RJ-12
- ✓ Available as Solder Kits, Pushpin Kits
- ✓ Complete with Case, Connectors, Captive Screws and Saddle Washers

ORDERING INFORMATION

Model 11, DB-25 to RJ-11/12

- 11KS M: DB-25 Male, solder kit
- 11KS F: DB-25 Female, solder kit
- 11KP M: DB-25 Male, pushpin kit
- 11KP F: DB-25 Female, pushpin kit

HD-15 to Modular Adapter

Model 15HD



FEATURES & BENEFITS

- ✓ High Density 15 Pin Connector (Male or Female) to RJ-11/RJ-12 or RJ-45
- ✓ Available as Solder Kits, Pushpin Kits

Model 12, DB-25 to RJ-45

- 12KS M: DB-25 Male, solder kit
- 12KS F: DB-25 Female, solder kit
- 12KP M: DB-25 Male, pushpin kit
- 12KP F: DB-25 Female, pushpin kit

DB-9 & DB-15 Modular Adapters

Models 15 & 16



FEATURES & BENEFITS

- ✓ High Density 15 Pin Connector (Male or Female) to RJ-11/RJ-12 or RJ-45
- ✓ Available as Solder Kits, Pushpin Kits

Model 15HD11, HD15 to RJ-11/12

- 15HD11KS M: HD15 Male, solder kit
- 15HD11KS F: HD15 Female, solder kit
- 15HD11KP M: HD15 Male, pushpin kit
- 15HD11KP F: HD15 Female, pushpin kit

DB-25 PocketTester™

Model 50



FEATURES & BENEFITS

- ✓ Monitors Async RS-232 Pins 2, 3, 4, 5, 6, 8, and 20
- ✓ All 25 Pins are Wired Straight Through
- ✓ 1 Male & 1 Female DB-25 Connector
- ✓ Interface Powered—No AC Power or Batteries Needed
- ✓ Data bias can be inferred from intensity of the colors

Model 15HD45, HD15 to RJ-45

- 15HD45KS M: HD15 Male, solder kit
- 15HD45KS F: HD15 Female, solder kit
- 15HD45KP M: HD15 Male, pushpin kit
- 15HD45KP F: HD15 Female, pushpin kit

PocketBOB™ DB-25 Breakout Box

Model 50-9



FEATURES & BENEFITS

- ✓ No AC Power or Batteries Required
- ✓ Seven Dual Color LEDs
- ✓ All 25 Pins From Both Connectors have Easily Accessible Probe Points
- ✓ Gold-plated sockets in the shape of a DB-25 connector allow easy set up and re-configuration of pin outs
- ✓ Three sets of sockets make looping and jumpering easier

Model 15, DB-15 to RJ-11/12 or RJ-45

- 1511KPM: DB-15 Male, pushpin kit
- 1511KPF: DB-15 Female, pushpin kit
- 1545KPM: DB-15 Male, pushpin kit
- 1545KPF: DB-15 Female, pushpin kit

Model 16, DB-9 to RJ-11/12 or RJ-45

- 1611KPM: DB-9 Male, pushpin kit
- 1611KPF: DB-9 Female, pushpin kit
- 1645KPM: DB-9 Male, pushpin kit
- 1645KPF: DB-9 Female, pushpin kit

DB-9 PocketTester™

Model 51



FEATURES & BENEFITS

- ✓ Seven LEDs Monitor RS-232 Signals
- ✓ All 9 Pins are Wired Straight Through
- ✓ Data Bias can be Inferred from the Intensity of the Colors
- ✓ 1 Male & 1 Female DB-9 Connector

Model 50

50MF: DB-25 PocketTester

Model 50-9, Breakout Box

50-9: PocketBOB™ DB-25

Model 51

51: DB-9 PocketTester™

Cable Adapters (Solder-Type or Solderless)

Models 8 & 8x MF

Comes with one male and one female connector for universal use.

Use a regular, straight cable and our Model 8 Cable Adapter to make it into any "special" cable you need. We include a pressure-sensitive label where you can mark your wiring connections.



The 8X MF unit is identical to our Model 8 except that all the connections are made using individual pin jacks and 24 gauge,

solid-wire jumpers. Any RS-232C wiring arrangement can be made without soldering and can be easily changed by simply re-arranging the jumpers. Our new snap-together/pop-open case encloses the wiring, and has enough height (0.4 inch) to allow all 25 jumpers to be used! We also give you pressure-sensitive labels where you can draw your wiring connections, plus a clear plastic cover to stick on them for protection.

FEATURES & BENEFITS

- ✓ Easy access to all 25 pins
- ✓ High quality PCB construction
- ✓ Wiring buses for easy jumpering
- ✓ All connector hardware provided
- ✓ Model 8 (solder-type) available in MM, MF or FF gender combos
- ✓ Model 8X (solderless) has one male, one female DB-25
- ✓ Case and label included—make your own durable custom adapter!

You wire it yourself (solder connections) using the 25 jumpers we supply.



ORDERING INFORMATION

Models 8 & 8X

8-FF: DB-25 Female to DB-25 Female Solder Type Adapter

8-MF: DB-25 Male to DB-25 Female Solder Type Adapter

8-MM: DB-25 Male to DB-25 Male Solder Type Adapter

8X MF: DB-25 Male to DB-25 Female Solder-less Type Adapter



I'm Nathan, Patton's NMS Product Line Manager. If you do not find the solutions you need at www.patton.com or in this catalog, please call me at +1 301.975.1000, x129. You can also send e-mail to nathan@patton.com.



DB-25 Micro Breakout Box

Model 9



FEATURES & BENEFITS

- ✓ All 25 Pins From Both DB-25 Connectors are Accessible
- ✓ Gold Plated Sockets
- ✓ Three Sets of Sockets to Make Jumpering Easy
- ✓ 25 Jumpers Supplied (19 AWG, solid)
- ✓ One Male & One Female DB-25 Connector

ORDERING INFORMATION

Model 9, Breakout Box

9MF: DB-25 Micro Breakout Box

DB-25 to Terminal Block Adapter

Model 14TB



FEATURES & BENEFITS

- ✓ Lets You Terminal Bare Wires to a DB-25 (Specify Male or Female)
- ✓ Strain Relief Collar Holds the Cable Firmly in Place—Won't Pull Out
- ✓ Printed Circuit Board Construction
- ✓ Screw Termination for 15 RS-232 Pins/Signals: 1-GND, 2-TD, 3-RD, 4-RTS, 5-CTS, 6-DSR, 7-SG, 8-CD, 9-(+DC) Test, 15-TXC, 17-RXC, 18-LL, 20-DTR, 25-Test Mode.

ORDERING INFORMATION

Model 14TB, DB-25 to Terminal Block Adapter

14TB F: DB-25 Female

14TB M: DB-25 Male



DB-25 Gender Changer

Model 2-25

The Model 2-25 is a handy device that's priced right! All 25 pins are wired straight through using printed circuit board construction. These units are available with male or female con-



nectors, and all necessary hardware is included. Male and female units are assembled with captive screws and saddle washers on one end, and hex nuts with locking hardware on the other.

FEATURES & BENEFITS

- ✓ Printed circuit board construction
- ✓ All 25 pins are wired straight through
- ✓ Specify male–male or female–female
- ✓ Captive screws/saddle washers on one end, hex nuts/locking hardware on the other end

DB-9 & DB-15 Gender Changers

Models 2-9 & 2-15

Models 2-9 & 2-15 connect mismatched cables as well as other devices. All 9 pins are wired straight-through using



printed circuit board construction. Male units are supplied with hex nuts and saddle washers.

FEATURES & BENEFITS

- ✓ Printed circuit board construction
- ✓ All 9 pins (Model 2-9) or all 15 pins (Model 2-15) are wired straight through
- ✓ Specify male–male or female–female
- ✓ Captive screws/saddle washers on one end, hex nuts/locking hardware on the other end

DB-25 Cube Tap

Model 4

This cube tap takes the data tap one step further. As you might imagine, the Model 4 has all 25 pins of all four connectors wired straight through. It's like having a single data tap with



up to four different gender combinations. Or it's like having a "universal gender changer." You can even use it to create a DB-25 "X" cable.

FEATURES & BENEFITS

- ✓ Data junction box with all 25 pins connected straight through on all four connectors
- ✓ Available with *all possible* gender combinations (normally supplied with two male and two female connectors)

DB-9 to DB-25 Adapters

Models 18PC-M & 18PC-P



FEATURES & BENEFITS

- ✓ Printed circuit board construction
- ✓ Model 18PC-M connects a 9-pin PC serial port to a 25-pin modem cable (DB-9F to DB-25M)
- ✓ Model 18PC-P connects a 9-pin PC serial port to a 25-pin printer cable (DB-9F to DB-25F)

ORDERING INFORMATION

Model 2-25
2-25: DB-25 Gender Changer

Model 4
4: DB-25 Cube Tap (specify genders)

Models 18PC-M & 18PC-P
18PC-M: DB-9F to DB-25M Adapter for modems
18PC-P: DB-9F to DB-25F Adapter for modems

Models 2-9 & 2-15
2-9: DB-9 Gender Changer
2-15: DB-15 Gender Changer

Note: More models are available, including low profile, call for details.

Technical Reference

EIA-232, EIA-232-E, EIA-574, & EIA-561 Interfaces

In This Section

Technical Reference	245
EIA-232, EIA-574 & EIA-561 Interfaces	245
V.35 Interface	246
EIA-449 (V.36) & EIA-530 Interface	247
X.21 Interface	248
Parallel & IEEE-1284 Interfaces	249
Modular Connections & Pairing	250

EIA-232 Interface Reference

EIA-232 defines the connection on a DB25 interface connector for nonsynchronous or synchronous operation.

Signal/Voltage Source	Signal Designations	Signal Designations	Signal/Voltage Source
DTE	Secondary Transmitted Data 14	1 Shield	Common
DCE	Transmit Clock 15	2 (TD) Transmitted Data	DTE
DCE	Secondary Received Data 16	3 (RD) Received Data	DCE
DCE	Receiver Clock 17	4 (RTS) Request To Send	DTE
DTE	Local Loopback 18	5 (CTS) Clear To Send	DCE
DTE	Secondary Request To Send 19	6 (DSR) DCE Ready	DCE
DTE	Data Terminal Ready 20	7 Signal Ground	Common
DTE	Remote Loopback 21	8 (CD) Rcvd Line Signal Detect	DCE
DCE	Ring Indicator 22	9 (+) DC Test Voltage	-
DTE/DCE	Data Signal Rate Selector 23	10 (-) DC Test Voltage	-
DTE	External Transmit Clock 24	11 Unassigned	-
DCE	Test Mode 25	12 (SCF/CI) Secondary CD	DCE
		13 Secondary Clear To Send	DCE

EIA-232-E (Alt A) Interface Reference (Male)

EIA-232-E defines a high density 26-pin connector called the Alt A connector.

Signal/Voltage Source	Signal Designations	Signal Designations	Signal/Voltage Source
DCE	(CTS) Clear To Send 13	26 Not Used	-
	Not Used 12	25 Test Mode	DCE
	Not Used 11	24 External Transmit Clock (XTC)	DTE
	Reserved for Testing 10	23 Data Rate Signal Selector	DTE/DCE
	Reserved for Testing 9	22 Ring Indicator	DCE
DCE	(CD) Carrier Detect 8	21 Remote Loopback	DTE
Common	(SG) Signal Ground 7	20 Data Term Ready (DTR)	DTE
DCE	(DSR) Data Set Ready 6	19 Secondary RTS	DTE
DCE	(CTS) Clear To Send 5	18 Local Loopback	DTE
DTE	(RTS) Request To Send 4	17 Receive Clock (RC)	DCE
DCE	(RD) Receive Data 3	16 Secondary RD	DCE
DTE	(TD) Transmit Data 2	15 Transmit Clock (TC)	DCE
-	(FG) Shield 1	14 Secondary TD	DTE

Is your interface a DTE or a DCE?

In general, a DTE provides a voltage on the TD, RTS, and DTR pins of the DB-25 connector, whereas a DCE has voltage on the RD, CTS, DSR, and CD pins. Determine whether you have a DTE or DCE by performing the following procedure:

Note: The point of reference for all signals is the terminal (or PC).

- Using a volt meter, connect the black lead to pin 7 (signal ground) of the DB-25 connector. Attach the red lead to pin 2 (transmit data). If the measured voltage on pin 2 (TD) is more negative than -3 volts, it is a DTE, otherwise it should be near zero volts.
- Leave the the black lead connected to pin 7. Attach the red lead to pin 3 (receive data). If the voltage on pin 3 is more negative than -3 volts, it is a DCE.
- If pins 2 and 3 show a voltage of at least 3 volts, then either you are measuring incorrectly, or your device is not a standard EIA-232 device. Call technical support for assistance.

EIA-574 Interface Reference

EIA-574 standard defines EIA-232 on a DB-9 connector. (For nonsynchronous applications only, since it does not provide for the synchronous clocking signals.)

Signal/Voltage Source	Signal Designations	Signal Designations	Signal/Voltage Source
DCE	Data Set Ready 6	1 Receive Line Signal Detector	DCE
DTE	Request To Send 7	2 Received Data	DCE
DCE	Clear To Send 8	3 Transmitted Data	DTE
DCE	Ring Indicator 9	4 Data Terminal Ready	DTE
		5 Ground/common Return	Common

V.35 Interface

CCITT V.35 uses two types of circuits: balanced and unbalanced (V.28). Recommendation V.28 is essentially the electrical equivalent of EIA-232, whereas V.24 is essentially the functional equivalent of EIA-232. This includes signal defini-

tion and use. DTE & DCE conform to the same perspective as EIA-232. V.35 signals are commonly implemented on the rectangular M/34 connector (34 pins). CCITT V.35 signals may also be implemented on the DB-25 connector (25 pins).

V.35 (on M/34 connector) Interface Reference

EIA-561 defines RS-232 on a modular connector. (For nonsynchronous applications only, since it does not provide for the synchronous clocking signals.)

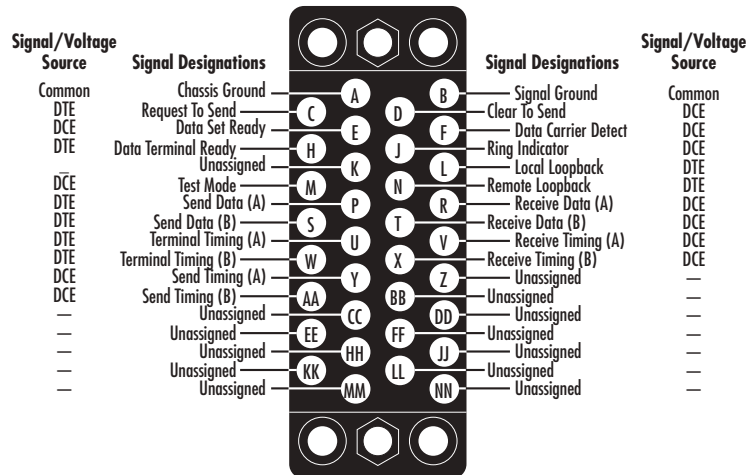

V.35 (on DB-25 connector) Interface Reference

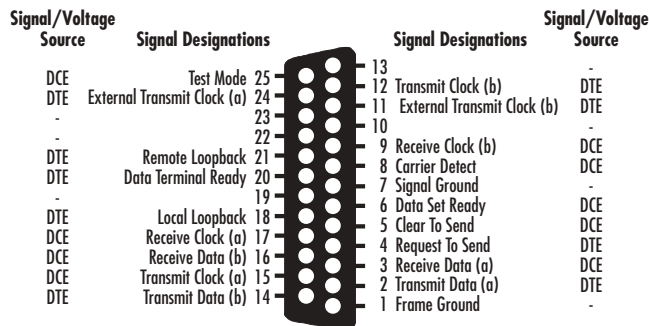

ELECTRICAL CHARACTERISTICS

Balanced Circuits

- Circuit 103: TD
- Circuit 104: RD
- Circuit 114: TC
- Circuit 115: RC

Cable: Balanced twisted multi-pair. Characteristic impedance = 80 to 120 ohms at the fundamental frequency

Generator: Source impedance = 50 to 150 ohms.

Voltage: With a 100-ohm load, $V(ab) = 0.55$ volts $\pm 20\%$ where terminal *a* is more positive than *b* for a binary zero, and terminal *b* is more positive than *a* for a binary one.

Load: Input impedance = 100 ± 10 ohms

Unbalanced Circuits (CCITT V.28)

- Circuit 102: Signal Ground
- Circuit 105: RTS
- Circuit 106: Ready for Sending (CTS)
- Circuit 107: DSR
- Circuit 109: CD

V.35 Pinout Comparison		
DB-25 Pinout	M34 Pinout	Signal
1	A	Frame ground
7	B	Signal ground
4	C	RTS
5	D	CTS
6	E	DSR
8	F	CD
20	H	DTR
18	L	LL
25	M	TM
21	N	RL
2	P	TD-a
3	R	RD-a
14	S	TD-b
16	T	RD-b
24	U	XTC-a
17	V	RC-a
11	W	XTC-b
9	X	RC-b
15	Y	TC-a
12	AA	TC-b

EIA-449 (V.36) & EIA-530 Interfaces

EIA-530 is a physical interface that uses two types of circuits: balanced (EIA-422) and unbalanced (EIA-423). EIA-530 calls out the DB-25 connector.

EIA-449 (V.36) is a physical interface that uses two types of circuits: balanced (EIA-422) and unbalanced (EIA-423). EIA-449 specifies the DB-37 connector.

EIA-449 (V.36) Interface Reference

Signal/Voltage Source	Signal Designations	Signal Designations	Signal/Voltage Source
Common	Receive Common 20	1 Shield	Common
-	Unassigned 21	2 Signal Rate Indicator	DCE
DTE	Send Data (B) 22	3 Signal Rate Indicator	-
DCE	Send Timing (B) 23	4 Send Data (A)	DTE
DCE	Receive Data (B) 24	5 Send Timing (A)	DCE
Return	Request To Send (B) 25	6 Receive Data (A)	DCE
DCE	Receive Timing (B) 26	7 Request To Send (A)	DTE
Return	Clear To Send (B) 27	8 Receive Timing (A)	DCE
DTE	Terminal In Service 28	9 Clear To Send (A)	DCE
Return	Data Mode (B) 29	10 Local Loopback	DTE
Return	Terminal Ready (B) 30	11 Data Mode (A)	DCE
Return	Receiver Ready (B) 31	12 Terminal Ready (A)	DTE
DTE	Select Standby 32	13 Receive Ready (A)	DCE
DCE	Signal Quality 33	14 Remote Loopback	DTE
DTE	New Signal 34	15 Incoming Call	DCE
DTE	Terminal Timing (B) 35	16 Select Frequency	DTE
DCE	Standby/indicator 36	17 Terminal Timing (A)	DTE
Common	Send Common 37	18 Test Mode	DCE
		19 Signal Ground	Common

EIA-530 Interface Reference

Signal/Voltage Source	Signal Designations	Signal Designations	Signal/Voltage Source
DTE	Transmitted Data (B) 14	1 Shield	Common
DCE	Transmit Clock (A) 15	2 Transmitted Data (A)	DTE
DCE	Received Data (B) 16	3 Received Data (A)	DCE
DCE	Receiver Clock (A) 17	4 Request To Send (A)	DTE
DTE	Local Loopback 18	5 Clear To Send (A)	DCE
Common	Request To Send (B) 19	6 DCE Ready (A)	DCE
DTE	Data Terminal Ready (A) 20	7 Signal Ground	Common
DTE	Remote Loopback 21	8 Carrier Detect (A)	DCE
Common	Data Set Ready (B) 22	9 Receiver Clock (B)	DCE
Common	Data Terminal Ready (B) 23	10 Carrier Detect (B)	Common
DTE	DTE Transmitter Clock (A) 24	11 DTE Transmitter Clock (B)	DTE
DCE	Test Mode 25	12 Transmitter Clock (B)	DCE
		13 Clear To Send (B)	Common

EIA-530/449 Interconnection

EIA-530 Signal Name	DB-25 Pin #	DB-37 Pin #	EIA-449 Signal Name
Shield	1	1	Shield
TD	2, 14	4, 22	Send Data
RD	3, 16	6, 24	Rcv Data
RTS	4, 19	7, 25	RTS
CTS	5, 13	9, 27	CTS
DCE Rdy	6, 22	11, 29	Data Mode
DTE Rdy	20, 23	12, 30	Term Rdy
SG	7	19	SG
CD	8, 10	13, 31	Rcvr Rdy
TSET (DCE-Src)	15, 12	5, 23	Send Tmg
RSET (DCE-Src)	17, 9	8, 26	Rcv Tmg
LL	18	10	LL
RL	21	14	RL
XTC (DTE-Src)	24, 11	17, 35	Term Tmg
TM	25	18	TM

EIA-530 Interface Pinout DB-25

		Pin #	Pin #		
Transmit Data-B	BA	14	1	Shield	
TSET (DCE-Src)-A	DB	15	2	BA	Transmit Data-A
Recv Data-B	BB	16	3	BB	Receive Data-A
TSET (DCE-Src)-A	DD	17	4	CA	RTS-A
Local Loop	LL(ii)	18	5	CB	CTS-A
RTS-B	CA	19	6	CC	DCE Ready-A
DTE Rdy-A	CD	20	7	AB	Signal Ground
Remote Loop	RL(ii)	21	8	CF	RLSD-A (CD-A)
			9	DD	Recv Signal Element Timing(DCE-Src)-B
DCE Rdy-B	CC	22	10	CF	RLSD-B (CD-B)
DTE Rdy-B	CD	23	11	DA	Trans Signal Element Timing (DTE-Src)-B
TSET(DTE-Src)-A	DA	24	12	DB	Trans Signal Element Timing (DCE-Src)-B
Test Mode	TM(ii)	25	13	CB	CTS-B

(ii) Indicates Category II circuits.

Category I Circuits: The circuits electrically specified as EIA-422.

Category II Circuits: Circuits electrically specified as EIA-423.

X.21 Interface

CCITT X.21 is a physical and electrical interface that uses two types of circuits: balanced (X.27/V.11) and unbalanced (X.26/V.10). CCITT X.21 calls out the DB-15 connector.

Equivalent/corresponding EIA-232 or CCITT V.35 signals

Transmit = TD

Receive = RD

Control = RTS

Indication = CD

Signal Element Timing = TC & RC (see note 2)

Byte Timing = rarely used

DTE Signal Element Timing: even more rarely used. Not supported (see note 4)

Clocking with X.21

How can only one clock signal be used for both data signals, T & R? With EIA-232 or V.35, the TC & RC are kept separate.

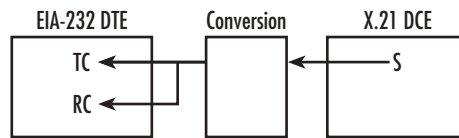

As shown in the diagram above, if the DTE is EIA-232/V.24 and the DCE is X.21, clock signal S comes from the DCE toward the DTE and both TC & RC are inputs on the DTE. After the X.21 signal is converted to the proper electrical format, connect the clock signal S to both TC & RC on the DTE.

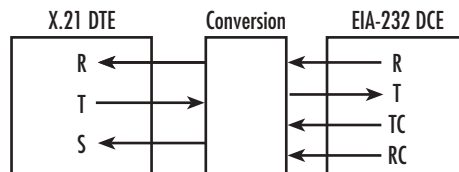

As shown above, if the DTE is X.21 and the DCE is EIA-232/V.35, both TC & RC must be combined into one clocking signal for X.21. Insert a data buffer between the DTE and DCE which will be controlled by both clocks. This will maintain the clock frequency lock without requiring TC & RC from DCE to phase locked.

ELECTRICAL CHARACTERISTICS

Data signaling rates of 9600 bps and below.

V.27 (= V.11) & X.26 (= V.10)

Data signaling rates above 9600 bps.

X.27 (= V.11)

[V.10 specifies an interface circuit with an unbalanced transmitter with a differential receiver.]

[V.11 specifies an interface circuit with a differential, balanced signal from transmitter to receiver which may accommodate an optional DC offset voltage. This approximates EIA-422]

X.21 Interface Reference

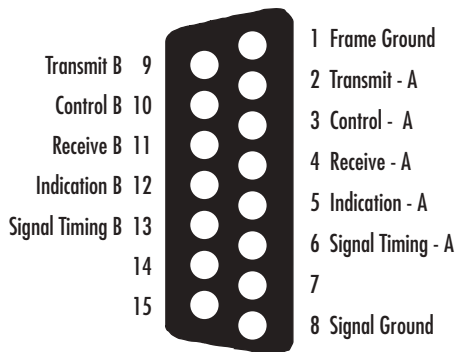

Functional characteristics of interchange circuits					
Interchange		Direction			
Circuits	DB15	Name	To DCE	From DCE	Remarks
G	1	Signal Ground or Common Return			See Note 1
Ga	8	DTE Common Return	X		
T	2 & 9	Transmit	X	X	
R	4 & 11	Receive		X	
C	3 & 10	Control	X	X	
I	5 & 12	Indication		X	
S	6 & 13	Signal Element Timing		X	See Note 2
B		Byte Timing			See Note 3
X		DTE Signal Element Timing	X		See Note 4

(ii) Indicates Category II circuits.

Category I Circuits: The circuits electrically specified as EIA-422.

Category II Circuits: Circuits electrically specified as EIA-423.

Note 1: This conductor may be used to reduce environmental signal interference at the interface. In the case of shielded interconnecting cable, the additional connection considerations are part of Recommendation X.24 and ISO 4903.

Note 2: Timing for continuous isochronous data transmission will be provided.

Note 3: May be provided as an optional additional facility

Note 4: The use and the termination of this circuit by the DCE is a national matter

Parallel & IEEE-1284 Interfaces

Standard Parallel

Both the 36-pin Centronics® and DB-25 connectors are commonly used for Computer-to-Printer communication. The two physical variations are electrically compatible with one another, so that only a special cable is required to allow them to operate with each other.

IEEE-1284 Bi-Directional Parallel

Standard Parallel communication sends data (in parallel) in one direction. So a host can send data to a printer, but the printer cannot send data back to the host. The only way the

printer can communicate vital feedback to the host (“out of paper,” “buffer full,” etc.) is to raise or lower a control pin. The IEEE-1284 Standard outlines methods by which a printer can receive data from a host (*forward channel*) and communicate data back to the host (*reverse channel*)—not just raise or lower control pins.

The two primary IEEE-1284 modes (the ones used by Patton hardware) are “Compatible” and “Nibble.” *Compatible Mode* is the baseline, and is simply forward channel parallel communication as implemented in the “classic” 36-pin

Centronics® format. *Nibble Mode* is reverse channel communication using the four status lines of the parallel interface.

Here’s how Nibble Mode works: Data is sent from the printer to the host, under the control of the host. Since only four lines are used (instead of the eight commonly required for parallel data) the byte is segmented into two 4-bit pieces and sent sequentially down the line. The byte therefore becomes two “nibbles.”

Centronics Parallel Interface

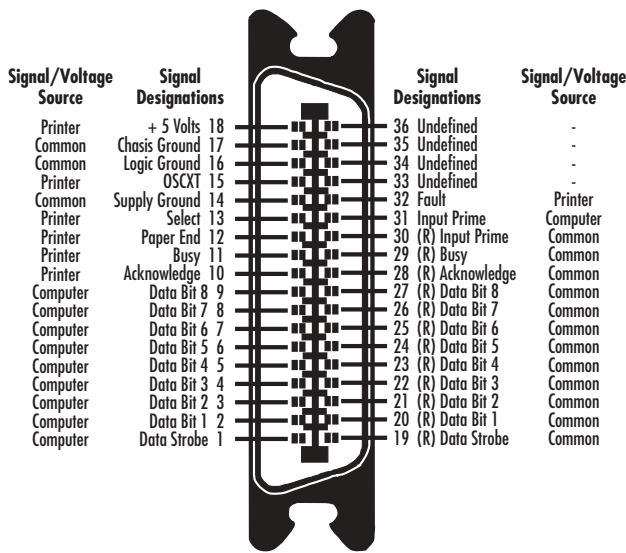

IBM PC Style Parallel Interface

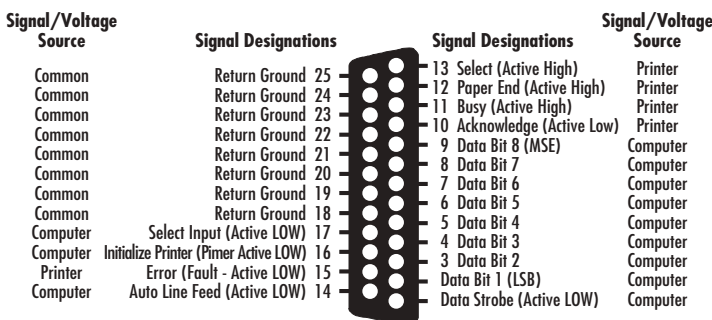

Primary IEEE-1284 Modes

DB-25 Pin #	DB-36 Pin #	Compatible Mode	Nibble Mode
1	1	nStrobe	HostClk
2	2	Data 1 (least significant bit)	
3	3	Data 2	
4	4	Data 3	
5	5	Data 4	
6	6	Data 5	
7	7	Data 6	
8	8	Data 7	
9	9	Data 8 (most significant bit)	
10	10	nAck	PtrClk
11	11	Busy	PtrBusy
12	12	PError	ActDataReq
13	13	Select	Xflag
14	14	nAutoFd	HostBusy
15	32	nFault	ndataAvail
16	31	nlNit	nlNit
17	36	nSelectIn	1284 Active
18	19	Signal Ground (nStrobe)	
19	20 & 21	SG (Data 1 & 2)	
20	22 & 23	SG (Data 3 & 4)	
21	24 & 25	SG (Data 5 & 6)	
22	26 & 27	SG (Data 7 & 8)	
23	29	SG (Busy & nFault)	
24	28	SG (PError, Select, and nAck)	
25	30	SG (nAutoFd, nSelectIn & nlNit)	

Not defined on the DB-36 connector: pins 15, 33, 34 & 35

Modular Connections and Pairing

Standard color codes for modular jacks with flying leads.

RJ-12 (6 pin)

1	blue
2	yellow
3	green
4	red
5	black
6	white

RJ-45 (8 pin)

1	blue
2	orange
3	black
4	red
5	green
6	yellow
7	brown
8	slate

Patton product interfaces as they are implemented on various modular jacks.

DDS Telco (RJ-45): Pins 1 (T1), 2 (T), 7 (R), 8 (R)

Patton Short Range Modem (RJ-45): Pins 1 (gnd), 2 (R-), 3 (T+), 4 (T-), 5 (R+), 6 (gnd), 7 (n/c), 8 (n/c)

ISDN BRI S/T (RJ-45): Pins 3 (T+), 4 (R+), 5 (R-), 6 (T-)

ISDN BRI U (RJ-45): Pins 4 (Tip+), 5 (Ring-)

TI/E1 Telco (RJ-45): Pins 1 (RX+), 2 (TX-), 4 (TX+), 5 (TX-)

Patton Short Range Modem (RJ-12): Pins 1 (gnd), 2 (R-), 3 (T+), 4 (T-), 5 (R+), 6 (gnd)

EIA-561 (RJ-45 8-pin): Pins 1 (RI), 2 (CD), 3 (DTR), 4 (SG), 5 (RD), 6 (TD), 7 (CTS), 8 (RTS)

Ethernet 10Base-T (RJ-45): Pins 1 (TX-), 2 (RX+), 3 (RX-), 6 (RX-)

How to connect two Patton short-range modems in a point-to-point topology.

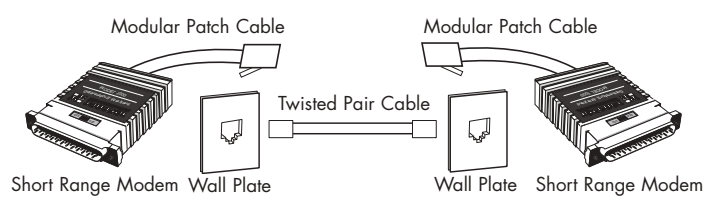

Step 1 — Pin-out the plugs on your modular patch cables so that they match one of the diagrams below. The cables are oriented with the plug pointing up and the clip to the back.

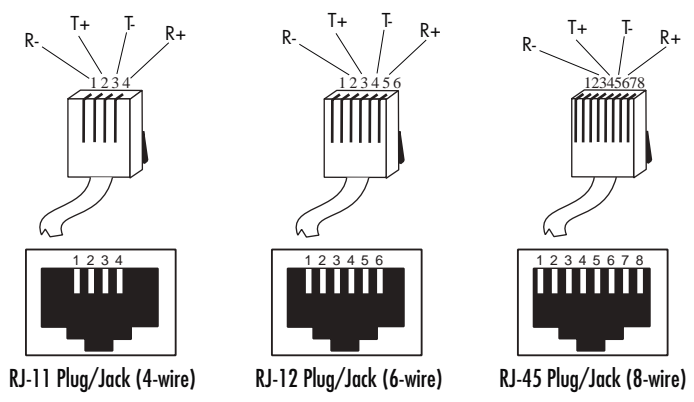

Step 2 — Make sure the wire pairing on the point-to-point connection (between wall plates) matches the diagram below. Colors may vary, but twisted pair cable must be used.

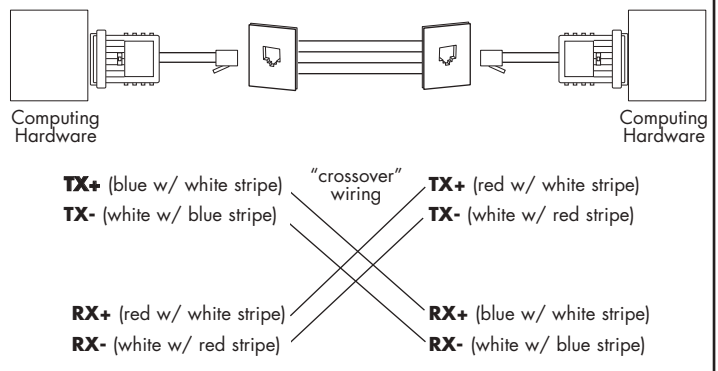

Model #	Page	Model #	Page	Model #	Page
1000	Basic Point-to-Point Async SRM—DB-25	203	1016	Transformer Isolated SRMs Guard Against Ground Loops	203
1000CU2	2-Slot Desktop ClusterBox	226	1018	Async Short-Range Modem with Extra Controls	209
1000CU4	4-Slot ClusterBox	226	1019	Transformer Isolated SRMs Guard Against Ground Loops	203
1000CU8	8-Slot ClusterBox	226	1020	Self-Powered Synchronous Short-Range Modem	207
1000R16	16-Slot 19-in. 2U Rack Chassis	226	1025	Self-Powered Synchronous Short-Range Modem	207
1001	High-Density Rack System for Universal Access	134	1030	Self-Powered Synchronous Short-Range Modem	207
1001MP10	10-Slot Universal Mounting Panel	138	1035	High-Speed Synchronous Short-Range Modem	208
1001MP10	10-Slot Universal Mounting Panel	228	1040	Sync/Async Short-Range Modem	206
1001MP16	16-Slot Universal Mounting Panel	139	1045	High-Speed Short-Range Modem—RS-232 to RS-530	209
1001MP16	16-Slot Universal Mounting Panel	229	1050	AC-Powered Async SRM—up to 38.4 kbps	210
1001MP2	2-Slot Universal Mounting Panel	138	1052AF	High-Speed Serial & RS-232 Extender	97
1001MP2	2-Slot Universal Mounting Panel	228	1052AF	High-Speed Serial & RS-232 Serial Extender	202
1002	Full-Duplex RS-232 over 2-Wire Twisted Pair or Coax	204	1053AF	High-Speed Serial & RS-232 Extender	97
1003	Full-Duplex RS-232 over 2-Wire Twisted Pair or Coax	204	1053AF	High-Speed Serial & RS-232 Serial Extender	202
1004A	High-Speed Multipoint Short-Haul Modem	205	1058	12.5 Mbps Fixed-Rate VDSL Voice & Data Modem/Router	91
1008	High-Speed Multipoint Short-Haul Modem—DB-9 Connector	205	1058RC	12.5 Mbps VDSL Voice & Data Rack Card	91
1009	Basic Point-to-Point Async SRM—DB-9	203	1060	AC-Powered Async STM—up to 115.2 kbps	210
1010B	Transformer Isolated SRMs Guard Against Ground Loops	203	1065	Industrial Short-Range Modem for Outdoor Use	213
1012ARC	Multidrop Transformer-Isolated Async Short-Range Modem Rack Card	206	1068	Variable-Rate VDSL Modem	92
1012B	Multidrop Transformer-Isolated Async Short-Range Modem	206	1070	AC-Powered SRM—Synchronous and Opto-Isolated	211
1013	RS-232 Bluetooth Wireless Modem 2-Pack	217	1075	AC-Powered X.21 SRM—Synchronous and Opto-Isolated	211
			1080A	Universal Short Range Modem	212
			1082	IDSL Modems with V.35, X.21, or 10Base-T Ethernet Interfaces	96
			1092A	KiloModem 2B1Q Encoding 2 or 4-Wire Baseband Modem	95
			11	DB-25 to RJ-11/12 Adapter	242
			1110A	Miniature Async RS-232 Fiber Optic Modem	216
			1140	Miniature Async/Sync RS-232 Fiber Optic Modem	216
			1173	IP Network Camera Extender	65
			12	DB-25 to RJ-45 Adapter	242
			1200	Synchronous Modem Eliminator	214
			1201	Synchronous Modem Eliminator	214
			1202	High-Speed Synchronous Modem Eliminator	214
			1203	High-Speed Synchronous Modem Eliminator	214
			1205	V.35 Synchronous Modem Eliminator	215
			1206	X.21 Synchronous Modem Eliminator	215
			1225	Self-Powered Line Extender	208
			1225	Self-Powered Parallel Line Extender	187
			1226	AC Powered Parallel Short Range Modem	187
			14TB	DB-25 to Terminal Block Adapter	243
			15	DB-15 Modular Adapter	242
			15HD	HD-15 to Modular Adapter	242
			16	DB-9 Modular Adapter	242
			18PC-M	DB-9 to DB-25 Adapter	244
			18PC-P	DB-9 to DB-25 Adapter	244
			2002	Self-Powered RS-232 to TTL	180
			2010	RS-232 Async to Sync Converter	172

Model #	Page	Model #	Page	Model #	Page
2011	High-Speed Async to Sync Converter172	2040	V.35 to HSSI Converter177	2130	EIA-530 DTE Ethernet MicroBridge65
2014	Passive RS-530 to V.35 Converter172	2041	X.21 to HSSI Converter177	2130	Ethernet to EIA-530 Converter/Bridge184
2015	Passive RS-449 to V.35 Converter173	2042	RS-422/530 to HSSI Converter177	2135	Ethernet to V.35 Converter/Bridge—No Serial Cable183
2016	Mini X.21 to V.35 Converter ...173	2066	RS-232/V.35 to X.21 Converter Rack Cards173	2135	V.35 DTE Ethernet MicroBridge—No Serial Cable ...65
2017 Series	RS-232 to Current Loop Converters—20mA or 60mA182	2070	Co-Directional G.703 Converter110	2135C	Ethernet to V.35 Converter/Bridge—With Serial Cable183
2018	RS-232 to 20mA Current Loop Converter—DB-25 to DB-25 ...182	2070	Co-Directional G.703 Converters169	2135C	V.35 DTE Ethernet MicroBridge—With Serial Cable ...65
2020 Series	Passive RS-232 to V.35 Converters174	2073	G.703/64-kbps Interface Converter111	2-15	DB-15 Gender Changer244
2020RC	RS-232 to V.35 Converter Rack Card174	2073	G.703/64-kbps Interface Converter169	2155	144 kbps LAN Extender61
2021	RS-232 to X.21 Interface Converter175	2084	2-Wire DB-25 Interface-Powered, RS-232 to RS-485 Interface Converter178	2156	2.3 Mbps CopperLink Ethernet Extender with Auto-Rate Adaptation60
2022	RS-232 to V.36 (RS-530/449) Interface Converter175	2085	4-Wire DB-25 Interface-Powered, RS-232 to RS-485 Interface Converter ...178	2157	4.6 Mbps CopperLink Ethernet Extender with Auto-Rate Adaptation60
2025	Auto-Directional Serial to Parallel Converter—DB-25, 38.4 kbps185	2086	Opto-Isolated DB-25 Interface-Powered, RS-232 to RS-485 Interface Converter ...178	2158	12.5 Mbps CopperLink Ethernet Extender59
2026	Compact Interface Serial to Parallel Converter185	2089	DB-9 Interface-Powered, RS-232 to RS-485 Interface Converter178	2168	16.67 Mbps Multi-Rate CopperLink Ethernet Extender ...58
2027	Compact Interface Serial to Parallel Converter185	2090	Micro V.35 to T1 Converter176	2172	50 Mbps Multi-Rate CopperLink Ethernet Extender57
2029	Auto-Directional Serial to Parallel Converter—DB-9, 38.4 kbps185	2094	Micro V.35 to G.703/G.704 E1 Converter176	2188	Bluetooth IP Access Point155
2030	RS-232/423 to IEEE-1284 Converter186	2113	CopperLink-T T1/E1 Extender ...63	2211	Wireless Single-Port Device Server151
2035	Auto-Directional Serial to Parallel Converter—DB-25, 115.2 kbps185	2115	Copper-Link T T1/E1 Extender ...63	222N	DB-25 Interface-Powered, RS-232 to RS-422 Converter ...180
2036	Compact Interface Serial to Parallel Converter185	2120	Ethernet to RS-232 Converter/Terminal Server183	222N9	DB-9 Interface-Powered, RS-232 to RS-422 Converter ...180
2036P	Powered Serial to Parallel Printer Converter186	2120	Micro Serial RAS123	222NRC	Interface-Powered RS-232 to RS-422 Converter Rack Card ...180
2037	Compact Interface Serial to Parallel Converter185	2121	Single-Port Terminal Server ...148	2232	Single Port RS-232 Device Server149
2039	Auto-Directional Serial to Parallel Converter—DB-9, 115.2 kbps185	2121	Ethernet MicroBridge, X.21 ...64	2234	4 Port Asynchronous RS-232 Device Server152
		2121	Ethernet to X.21 Converter/Bridge184		
		2124	Ethernet MicroBridge, V.2465		
		2124	Ethernet to V.24 Converter/Bridge184		

Model #	Page	Model #	Page	Model #	Page
2238	8 Port Asynchronous RS-232 Device Server152	2703	MegaLink-I 2 Mbps G.703 Access Converter107	2996	96 or 120 Port RedRAS118
2-25	DB-25 Gender Changer244	2703	MegaLink-I 2 Mbps G.703 Access Converter165	3	DB-25 Data Tap240
2284	4 Port Asynchronous RS-232/422/485 Device Server ..153	2707	Lowest Cost G.703 NTU108	3/11	Data Tap with 3 RJ-11 Connectors240
2285	RS-485/422/232 Universal Device Server150	2707	Lowest Cost G.703 NTU166	3/34	M/34 (V.35) Data Tap240
2288	8 Port Asynchronous RS-232/422/485 Device Server ..153	2710	T1/FT1 to V.35 Interface Converter/CSU/DSU with Control Port102	3/45	Data Tap with 3 RJ-45 Connectors240
2292	2 Port Leased Line Extender over IP154	2710	T1/FT1 to V.35 Interface Converter/CSU/DSU with Control Port160	3/9	DB-9 Data Tap240
2294	4 Port Leased Line Extender over IP154	2710RC	T1/FT1 High-Density Low-Cost CSU/DSU Rack Card103	3/9HDX	DB-9 Data Tap Half-Duplex ..240
2400	MicroLink CSU/DSU104	2710RC	T1/FT1 High-Density Low-Cost CSU/DSU Rack Card161	3001	Anti-Streaming Device215
2400	MicroLink CSU/DSU162	2715	MicroLink-E1 E1/FE1 Nx64 CSU/DSU109	3010	Modem Sharing Device225
2603	Low-Cost T1/E1 WAN Access Router48	2715	MicroLink-E1 E1/FE1 Nx64 CSU/DSU167	3012	Powered RS-232 Modem Sharing Device224
2604	4 Port Digital Cross Connect ...128	2715	MicroLink-E1 E1/FE1 Nx64 CSU/DSU167	3014	Powered RS-232 Modem Sharing Device224
2608	8 Port Digital Cross Connect ...128	2720	Compact T1/FT1 High-Density Low-Cost CSU/DSU100	3018	Powered RS-232 Modem Sharing Device224
2614	T1/E1 Managed DACS130	2720	Compact T1/FT1 High-Density Low-Cost CSU/DSU158	3022	Miniature 2-Channel Statistical Multiplexer220
2616	16 Port DACS132	2720	Compact T1/FT1 High-Density Low-Cost CSU/DSU158	3028	Powered 8-Channel Async/Sync Statistical Multiplexer221
2616RC	ForeFront Digital Cross Connect126	2802	2 Port Ethernet Managed VPN WAN Router46	3032	MicroStat 2-Channel Statistical Multiplexer220
2620	Integrated TDM & IP Router ...168	2803	T1/E1 Managed VPN WAN Router50	3034	Managed High-Speed RS-232 Async 4 Port Stat Mux219
2620	Integrated TDM & IP Router ...52	2805	5 Port Ethernet Managed VPN WAN Router46	3038	Managed High-Speed RS-232 Async 8 Port Stat Mux219
2621	Sync Serial X.21 WAN Router ...49	2821	Sync Serial X.21 Managed VPN WAN Router51	3040	Digital Sharing Device223
2635	Sync Serial V.35 WAN Router ...49	2823	DMZ Secure Router47	3042	Low-Speed Time-Division Multiplexer220
2701	G.703/G.704 NTU104	2835	Sync Serial V.35 Managed VPN WAN Router51	305	Micro Modem Splitter225
2701	G.703/G.704 NTU162	2884	Channelized Gigabit Router ...53	3054	4 Port Channel Limited Distance Multiplexer222
2701/1	Compact Ethernet-over-E1 WAN Bridge65	2888	Multi-Megabit Inverse Mux ...54	3056	6 Port Channel Limited Distance Multiplexer222
2701RC	Compact Ethernet-over-E1 WAN Bridge Rack Card65	2-9	DB-9 Gender Changer244	3058	8 Port Channel Limited Distance Multiplexer222
2701RC	G.703/G.704 NTU Rack Card ..104	2960	16, 24, 30, 48, or 60 Port RedRAS116	3060	Digital Sharing Device223
2701RC	G.703/G.704 NTU Rack Card ..162	2977A	T1/E1 RAS & Fax Adapter ...122	3080	Digital Sharing Device223

Model #		Page	Model #		Page	Model #		Page
3086	G.SHDSL Integrated Access Device	86	430 Series	Single Port E1/E2 IDC Krone Baluns	190	502	Sync DB-25 Surge Protector	232
3086FR	G.SHDSL FRF.5/FRF.8 over ATM IAD	88	450RC24	Ultra High-Density G.703 (E1) Balun Panel	195	503P	36-Pin Parallel Surge Protector	233
3087	Serial G.SHDSL Bridge/Router ..	87	460	G.703 (E1, E2, E3) Balun—2 Mbps 75-ohm to 120-ohm	192	503PC	DB-25 Parallel Surge Protector	233
3088	Low-Cost High-Speed G.SHDSL Modem	84	460MC	G.703 Balun (E1) 2 Mbps With Built-In Cables—75-ohm to 120-ohm	192	503S	Serial DB-25 Surge Protector—All 25 Leads	232
3088FR	G.SHDSL FRF.5/FRF.8 over ATM NTU	85	460RC	G.703 (E1) Balun Panels—RJ-45 Jack to Dual BNC Female	194	50-9	PocketBOB DB-25 Breakout Box	242
3092	IDSL DACS Provides Quad T1/E1 & 24 IDSL Ports	94	462	G.703 (E1, E2, E3) Balun—8 Mbps 75-ohm to 100-ohm	192	509	Sync DB-9 Surge Protector	232
3096RC	ForeFront G.SHDSL Line Card	74	463	G.703 (E1, E2, E3) Balun—34 Mbps 75-ohm to 120-ohm	192	51	DB-9 PockeTester	242
310 Series	CCTV Passive Baluns	198	464RC	High-Density E1/G.703 Balun Panel—BNC Coax Connector	196	510	4-Line Modular Surge Protector	233
3101RC	ForeFront ADSL2+ Triple-Play Access	76	465	G.703 (E1) Balun—2 Mbps (1.6/5.6 Connectors)	193	511	6-Line Modular Surge Protector	233
3120	96 or 120 Port Dial-up RedRAS	120	465MC	G.703 (E1) Balun—2 Mbps (1.6/5.6 BNC Connectors)	193	512	8-Line Modular Surge Protector	233
3125RC	ForeFront 96 or 120 Port RAS Card with T1/E1 Transition Module	114	465RC	G.703 (E1) Balun Panels—RJ-45 Jack to Dual 1.6/5.6 Female	194	515	Sync DB-15 Surge Protector	232
3196RC	ForeFront IDSL Line Card	75	466RC	High-Density E1/G.703 Balun Panel—1.6/5.6 Coax Connector	196	51X Series	Multiport RS-232 & RS-422 Surge Protectors	235
320 Series	CCTV Passive Pass-Thru Baluns ..	198	470	155 Mbps ATM Balun Swap Coax for Twisted Pair—100-ohm	193	52X Series	Terminal Strip Surge Protectors	239
3201	G.SHDSL High-Speed Router	89	471	155 Mbps ATM Balun Swap Coax for Twisted Pair—120-ohm	193	530	Thick Coax Ethernet Surge Protector	235
3210	G.SHDSL.bis VPN Router	90	472	155 Mbps ATM Balun Swap Coax for Twisted Pair—150-ohm	193	531	Thin Coax Ethernet Surge Protector	235
3224	High-Speed G.SHDSL Concentrator for IP Traffic	80	5	Pin 2-3 Reverser	241	534	Ethernet AUI Surge Protector—DB-15	236
3241	G.SHDSL High-Speed Router with IP Access Feature Set	89	50	DB-25 PockeTester	242	535	802.5 Token Ring Surge Protector—Type 1	236
330 Series	CATV Passive Baluns	199	500	Async DB-25 Surge Protector	232	536	802.5 Token Ring Surge Protector—Type 3	236
3324	VDSL Access Concentrator Switch	82	501	Async DB-25 Surge Protector	232	537	802.5 Token Ring Surge Protector—Type B	236
350	Component Video Balun	199	501LC	Async DB-25 Low Capacitance Surge Protector	232	542	CCTV (BNC) Video Surge Protector	236
3P-MF	Power Supply Adapter—DB-15 ..	240				543	SATV, VSAT, DirectTV (F-Type) Video Surge Protector	236
3PMF9	Power Supply Adapter—DB-9 ..	240				545	Twinax Surge Protector for IBM AS/400	236
4	DB-25 Cube Tap	244				546	V.35 (M/34) Surge Protector	237
400	IBM 3270 Coax to Twisted Pair Baluns	197						
410	Twinax to Twisted Pair Adapter Balun	197						

Model #	Page	Model #	Page	Model #	Page
552 Series	Telco Line Surge Protectors238	6C	Async Null Modem Adapter—Full Handshake241	IPLink 2635	(See 2635)
570	10/100Base-TX (Cat-5) Secondary Surge Protector234	6L	Loopback Adapter241	IPLink 2802	(See 2802)
570-POE	10/100Base-TX (Cat-5) Secondary Surge Protector234	7	Modular to Modular Adapter . .241	IPLink 2803	(See 2803)
57X	10/100Base-TX (CAT-5) Protector Point for Use234	8	Cable Adapter—Solder Type . . .243	IPLink 2805	(See 2805)
580	10/100Base-TX (Cat-5) Secondary Surge Protector234	80	RS-232 Interface Connector . . .241	IPLink 2821	(See 2821)
580-POE	10/100Base-TX (Cat-5) Secondary Surge Protector234	8XMF	Cable Adapter—Solder-less . . .243	IPLink 2823	(See 2823)
58X	10/100Base-TX (CAT-5) Protector for Wiring Closets . .234	9	DB-25 Micro Breakout Box . . .243	IPLink 2835	(See 2835)
590 Series	Asynchronous RS-232 Optical Isolators237	Bundles, VoIP	VoIP User Packages38	IPLink 2884	(See 2884)
593 Series	RS-422/485 Optical Isolators . .237	CopperLink 2155	(See 2155)	IPLink 2888	(See 2888)
6072	Diskless NanoServ—Thin Case . .146	CopperLink 2156	(See 2156)	M-AFA	Mico-Analog Fax Adapter16
6073	Diskless NanoServ—Ultra-Thin Case146	CopperLink 2157	(See 2157)	M-ATA	Micro-Analog Telephone Adapter16
6074	NanoServ with 256MB Flash Drive—Thin Case146	CopperLink 2158	(See 2158)	S-ATA	Residential Analog Telephone Adapter17
6075	NanoServ with 256MB Hard Disk—Thin Case146	CopperLink 2168	(See 2168)	S-DTA	Residential Digital Telephone Adapter19
6081RC	ForeFront Router Line Card77	CopperLink 2172	(See 2172)	SipXNano	IP-PBX Nanoserver32
6276	ForeFront Half-Pipe 4-Slot Chassis System70	CopperLink-T 2113	(See 2113)	SL4020 Series	Analog VoIP SoHo Router20
6300	ForeSight 6300 Network Management System72	CopperLink-T 2115	(See 2115)	SL4050 Series	SIP Telephones34
6400 Series	Modular T1/E1 Edge/Access Router55	ForeFront 2616RC	(See 2616RC)	SL4250	IP-PBX35
6476	ForeFront Full-Pipe 8-Slot Chassis System70	ForeFront 3096RC	(See 3096RC)	Smart-ATA	Residential Analog Telephone Adapter17
6500 Series	ForeFront Multi-Port Digital Cross Connects125	ForeFront 3101RC	(See 3101RC)	Smart-DTA	Residential Digital Telephone Adapter19
6511	Matrix Switch Line Card78	ForeFront 3125RC	(See 3125RC)	SmartLink 4020 Series	(See SL4020 Series)
6676	ForeFront Xtreme 17-Slot Chassis System70	ForeFront 3196RC	(See 3196RC)	SmartLink 4050 Series	(See SL4050 Series)
6A	Async Null Modem Adapter—No Handshake241	ForeFront 6400 Series	(See 6400 Series)	SmartLink 4250	(See SL4250)
6B	Async Null Modem Adapter—Standard Handshake241	ForeFront 6500 Series	(See 6500 Series)	SmartLink M-ATA	(See M-ATA)
		ForeSight 6300	(See 6300)	SmartNode 2400	(See SN2400)
		IC-4BRV	8-Channel Module Provides 4 ISDN BRI Interfaces31	SmartNode 4110 Series	(See SN4110 Series)
		IC-4FXS	4-Channel Module Provides 4 Analog Phone Ports31	SmartNode 4520 Series	(See SN4520 Series)
		IC-E1V	30-Channel E1 Module for ISDN PRI31	SmartNode 4552	(See SN4552)
		IC-T1V	23-Channel T1 Module for ISDN PRI31	SmartNode 4554	(See SN4554)
		IPLink 2603	(See 2603)	SmartNode 4562	(See SN4562)
		IPLink 2620	(See 2620)	SmartNode 4630 Series	(See SN4630 Series)
		IPLink 2621	(See 2621)	SmartNode 4650 Series	(See SN4650 Series)

Model #	Page	Model #	Page	Model #	Page
SmartNode 4830 Series (See <i>SN4830 Series</i>)		SN4528/JS	8 Port FXS VoIP Gateway Router	SN4912/JSX	12 Port FXS WAN Uplink IpChannel Bank
SmartNode 4900 Series (See <i>SN4900 Series</i>)		SN4552	Standard Small & Branch Office ISDN VoIP Router	SN4916/JO	16 Port FXO IpChannel Bank
SmartNode 4960 Series (See <i>SN4960 Series</i>)		SN4554	ISDN BRI PSTN Gateway	SN4916/JOX	16 Port FXO WAN Uplink IpChannel Bank
Smart-WTA Residential VoIP Analog WiFi Telephone Adapter	18	SN4562	Secure Small & Branch Office ISDN VoIP Router	SN4916/JS	16 Port FXS IpChannel Bank
SN2400 4-Slot Modular Router	30	SN4630 Series	Multi-Port ISDN VoIP IAD	SN4916/JSX	16 Port FXS WAN Uplink IpChannel Bank
SN4021 1 Port FXS VoIP Gateway Router	20	SN4634	Multi-Port ISDN VoIP IAD—4 VoIP Call	SN4924/JO	24 Port FXO IpChannel Bank
SN4022 2 Port FXS VoIP Gateway Router	20	SN4638	Multi-Port ISDN VoIP IAD—8 VoIP Call	SN4924/JOX	24 Port FXO WAN Uplink IpChannel Bank
SN4110 Series Multi-Port FXS/FXO VoIP Gateway	21	SN4650 Series	Multi-Port ISDN VoIP IAD with Integrated WAN Access	SN4924/JS	24 Port FXS IpChannel Bank
SN4112/JS 2 Port FXS VoIP Media Gateway	21	SN4654	3 BRI/SO 4-Call VoIP Router	SN4924/JSX	24 Port FXS WAN Uplink IpChannel Bank
SN4114/2JS2JO 2 FXS & 2 FXO Port VoIP Media Gateway	21	SN4658	5 BRI/SO 8-Call VoIP Router	SN4932/JO	32 Port FXO IpChannel Bank
SN4114/JS 4 Port FXS VoIP Media Gateway	21	SN4830 Series	FXS/FXO VoIP IAD with WAN Access	SN4932/JOX	32 Port FXO WAN Uplink IpChannel Bank
SN4116/JS 6 Port FXS VoIP Media Gateway	21	SN4832/JOX	2 FXO with Integrated WAN	SN4932/JS	32 Port FXS IpChannel Bank
SN4118/4JS4JO 4 FXS & 4 FXO Port VoIP Media Gateway	21	SN4832/JSX	2 Port FXS with Integrated WAN	SN4932/JSX	32 Port FXS WAN Uplink IpChannel Bank
SN4118/JS 8 Port FXS VoIP Media Gateway	21	SN4834/2JS2JOX	2 FXS 2 FXO with Integrated WAN	SN4960 Series	Multi-Port T1/E1 VoIP Integrated Access Device
SN4520 Series Multi-Port FXS/FXO VoIP Gateway Router	24	SN4834/JOX	4 FXO with Integrated WAN	SN-IC-4BRV	8-Channel Module Provides 4 ISDN BRI Interfaces
SN4522/JO 2 Port FXO VoIP Gateway Router	24	SN4834/JSX	4 Port FXS with Integrated WAN	SN-IC-4FXS	4-Channel Module Provides 4 Analog Phone Ports
SN4522/JS 2 Port FXS VoIP Gateway Router	24	SN4836/4JS4JOX	4 FXS 4 FXO with Integrated WAN	SN-IC-E1V	30-Channel E1 Module for ISDN PRI
SN4524/JO 4 Port FXO VoIP Gateway Router	24	SN4836/JSX	6 Port FXS with Integrated WAN	SN-IC-T1V	23-Channel T1 Module for ISDN PRI
SN4524/JS 4 Port FXS VoIP Gateway Router	24	SN4838/4JS4JOX	4 FXS 4 FXO with Integrated WAN	S-WTA	Residential VoIP Analog WiFi Telephone Adapter
SN4526/4JS2JO 4 Port FXS & 2 Port FXO VoIP Gateway Router	24	SN4838/JSX	8 Port FXS with Integrated WAN	VAPS	VoIP Auto-Provisioning System
SN4526/JS 6 Port FXS VoIP Gateway Router	24	SN4900 Series	IpChannel Bank Multi-Port FXS & FXO Gateway Router		
SN4528/4JS4JO 4 Port FXS & 4 Port FXO VoIP Gateway Router	24	SN4912/JO	12 Port FXO IpChannel Bank		
		SN4912/JOX	12 Port FXO WAN Uplink IpChannel Bank		
		SN4912/JS	12 Port FXS IpChannel Bank		

Description	Page	Description	Page	Description	Page
1 Port FXS VoIP Gateway Router	20	12.5-Mbps Fixed-Rate VDSL Voice and Data	91	2 FXS & 2 FXO Port with Integrated WAN	26
1.0/2.3 Female Panel Mount to IDC Krone	189	12.5-Mbps VDSL Voice and Data Rack Card	91	2 Mbps G.703 Access Converter	165
1.0/2.3 Male Panel Mount to IDC Krone	189	12.5-Mbps Variable-Rate VDSL Voice and Data	92	2 Mbps G.703 Access Converter	106, 164
1.6/5.6 Female Panel Mount to IDC Krone	189	12.5-Mbps Variable-Rate Voice and Data Rack Card	92	2 Mbps G.703 Access Converter Rack Card	164
1.6/5.6 Male Panel Mount to IDC Krone	189	120 ohm to 75 ohm Balun Rack, 16 Port	196	2 Mbps G.703 Access Converter Rack Card	106, 164
1.6/5.6 to Twisted Pair E1 (G.703) 16 port	189	120 ohm to 75 ohm balun, 2 Mbps	194	2 Mbps G.703 Access Converter, MicroPak	166
10/100Base-T (CAT-5) Protector Barrier	234	120 ohm to 75 ohm Balun, 34 Mbps	194	2 Mbps G.703 Access Converter, MicroPak ...	108, 166
10/100Base-T (CAT-5) Protector Point of Use	234	120 ohm to 75 ohm Balun, 8 Mbps	194	2 Port Ethernet Managed VPN WAN Router	46
10/100Base-T PoE Protector Barrier	234	120 ohm to 75 ohm dual Balun, 2 Mbps	192	2 Port FXO with Integrated WAN	26
10/100Base-T PoE Protector Point of Use	234	120 ohm to 75 ohm dual Balun, 34 Mbps	192	2 Port FXS or FXO VoIP Gateway Router	24
10/100Base-TX (CAT-5) Protector for Wiring Closets	234	120 ohm to 75 ohm dual Balun, 8 Mbps	192	2 Port FXS VoIP Gateway Router	20
10/100Base-TX (CAT-5) Protector Point for Use	234	144 kbps LAN Extender	61	2 Port FXS VoIP Media Gateway	21
10/100BaseTX to 4-Port RS-232 Device Server ...	152	155-Mbps ATM Balun Swap Coax for Twisted Pair, 75-ohm Dual-Coax BNC female to 100-ohm shielded RJ-45 jack	193	2 Port FXS with Integrated WAN	26
10/100BaseTX to 4-Port RS-232/422/485	153	155-Mbps ATM Balun Swap Coax for Twisted Pair, 75-ohm Dual-Coax BNC female to 120-ohm shielded RJ-45 jack	193	2-Port 2-wire Leased-Line Analog Extender over IP	154
10/100BaseTX to 8-Port RS-232 Device Server ...	152	155-Mbps ATM Balun Swap Coax for Twisted Pair, 75-ohm Dual-Coax BNC female to 150-ohm shielded RJ-45 jack	193	2-Port Leased-Line Extender over IP	154
10/100BaseTX to 8-Port RS-232/422/485	153	16 Port FXO IpChannel Bank	29	2-Slot Desktop ClusterBox	226
10/100BaseTX to RS-232/422/485	150	16 Port FXO WAN Uplink IpChannel Bank	29	2-Wire Network Access Bridge 144 kbps	61
100Base-T Surge Protector	230	16 Port FXS IpChannel Bank	29	2-Wire Network Access Bridge 16.67 Mbps	58
100Base-T Surge Protector, Multiport Hub	230	16 Port FXS WAN Uplink IpChannel Bank	29	2-Wire Network Access Bridge 2.3 Mbps	60
100Base-T Surge Protector, Rack Mount	230	16-Port DACS	132	2-Wire Network Access Bridge 4.6 Mbps	60
10Base-T Hub Protector	230	16-Port DACS Rack Card	126	2-Wire/4-Wire Baseband Modem	95
10Base-T Surge Protector, Single Port	230	16-Slot Universal Mounting Panel	229	2.3 Mbps CopperLink Ethernet Extender with Auto-Rate Adaptation	61
10BaseT to RS-232	149	16, 24, 30, 48, or 60-Port, V.92/V.90/ISDN, ...	116	20mA Curr. Loop to RS-232 Conv. Rack Card	180
10-Slot 19-in. 2U Rack Chassis	228	16.67 Mbps Multi-Rate CopperLink Ethernet Extender	58	20mA Curr. Loop to RS-232 Conv., Active	180
12 Port FXO IpChannel Bank	29	199-ohm to 100-ohm	192	20mA Current Loop Conv., Active, Dual DB-25 ...	180
12 Port FXO WAN Uplink IpChannel Bank	29	199-ohm to 244-ohm	192	23-Channel T1 Module for ISDN PRI	31
12 Port FXS IpChannel Bank	29	2 FXS & 2 FXO Port FXS VoIP Media Gateway ...	21	24 Port FXO IpChannel Bank	29
12 Port FXS WAN Uplink IpChannel Bank	29	2 FXS & 2 FXO Port Gateway Router	24	24 Port FXO WAN Uplink IpChannel Bank	29
12.5 Mbps CopperLink Ethernet Extender	59			24 Port FXS IpChannel Bank	29
12.5 Mbps, Full-Duplex Ethernet Extender Rack Card	59			24 Port FXS WAN Uplink IpChannel Bank	29
				2B1Q Baseband Modem	95

Description	Page	Description	Page	Description	Page
2B1Q Rack Card Modem	95	5 Port Ethernet Managed VPN WAN Router	46	802.11b to RS-232 Wireless Device Server	151
3 BRI/So 4-Call VoIP Router	27	56/188 CSU/DSU, MicroPak	162	802.3 Network Protector	234
30-Channel E1 Module for ISDN PRI	31	56/64 CSU/DSU, MicroPak	104, 162	802.3af Network Protector	234
30-Channel E1 Module for ISDN PRI	31	6 Port FXS VoIP Media Gateway	21	802.5 Type 1 Token Ring Surge Protector	236
32 Port FXO IpChannel Bank	29	6 Port FXS with Integrated WAN	26	802.5 Type 3 Token Ring Surge Protector	236
32 Port FXO WAN Uplink IpChannel Bank	29	6 Port VoIP Gateway Router	24	802.5 Type B Token Ring Surge Protector	236
32 Port FXS IpChannel Bank	29	6-Line Modular Surge Protector	233	96 or 120-Port Dial-up RedRAS	120
32 Port FXS WAN Uplink IpChannel Bank	29	6-Port Limited Distance Multiplexer	222	96 or 120-Port, V.92/V.90/ISDN, Dial-Up RAS	120
3270 Baluns, Coax (BNC)	188	60mA Curr. Loop to RS-232 Conv., Passive	180	AC Powered, Parallel Short Range Modem	187
3X/400 Twinax Balun	188	64K G.703 Access Converter, MicroPak	169	AC-Powered Asynchronous SRM—Up to 115.2 kbps	210
4 FXS & 2 FXO Port Gateway Router	24	64K G.703 Access Converter, MicroPak	110, 169	AC-Powered Asynchronous SRM—Up to 162.4 kbps	210
4 FXS & 4 FXO Port FXS VoIP Media Gateway	21	64K G.703 Access Converter, QuikConnect	169	AC-Powered Synchronous Opto- Isolated SRM	210
4 FXS & 4 FXO Port Gateway Router	24	64K G.703 Access Converter, QuikConnect	110, 169	AC-Powered X.21 Synchronous Opto- Isolated SRM	210
4 FXS & 4 FXO Port with Integrated WAN	26	64K G.703 Converter	169	Access Bridge 144 kbps	61
4 Port FXO with Integrated WAN	26	64K G.703 Converter	110, 169	Access Bridge 16.67 Mbps	58
4 Port FXS or FXO VoIP Gateway Router	24	75 ohm to 120 ohm Balun Rack, 16 Port	194	Access Bridge 2.3 Mbps	60
4 Port FXS VoIP Media Gateway	21	75 ohm to 120 ohm Balun Rack, 16 Port	192	Access Bridge 4.6 Mbps	60
4 Port FXS with Integrated WAN	26	75 ohm to 120 ohm balun, 2 Mbps	192	Access Converter G.703	162
4-Channel Module Provides 4 Analog Phone Ports	31	75 ohm to 120 ohm balun, 2 Mbps	192	Access Converter, 2 Mbps G.703	164
4-Channel Module Provides 4 Analog Phone Ports	31	75 ohm to 120 ohm Balun, 34 Mbps	192	Access Converter, 2 Mbps G.703, MicroPak	164
4-Line Modular Surge Protector	233	75 ohm to 120 ohm Balun, 8 Mbps	192	Access Converter, 64K G.703, MicroPak	110
4-Port 2-wire Leased-Line Analog Extender over IP	154	75 ohm to 120 ohm Balun, 8 Mbps	192	Access Converter, 64K G.703, QuikConnect	169
4-Port Asynchronous RS-232 Device Server	152	75 ohm to 120 ohm dual Balun, 2 Mbps	192	Access Unit, T1/E1	156
4-Port DACS	128	75 ohm to 120 ohm dual Balun, 34 Mbps	192	Adapter, DB-15 to RJ-11	242
4-Port Leased-Line Extender over IP	154	75 ohm to 120 ohm dual Balun, 8 Mbps	192	Adapter, DB-15 to RJ-169	242
4-Port Limited Distance Multiplexer	222	8 Port FXS VoIP Media Gateway	21	Adapter, DB-25 Loopback	241
4-Slot ClusterBox	226	8 Port FXS with Integrated WAN	24	Adapter, DB-25 Null Modem	241
4-Slot Modular Router	30	8 Port VoIP Gateway Router	22	Adapter, DB-25 Pin 2-3 Reverser	241
4.6 Mbps CopperLink Ethernet Extender	60	8-Channel Module Provides 4 ISDN BRI Interfaces	31	Adapter, DB-25 to DB-25, Solder Type	243
485/422/232 4-Port Device Server	153	8-Line Modular Surge Protector	233	Adapter, DB-25 to DB-25, Solderless	243
5 BRI/So 8-Call VoIP Router	27	8-Port Asynchronous RS-232 Device Server	152		
		8-Port DACS	128		
		8-Port Limited Distance Multiplexer	222		
		8-Slot ClusterBox	226		

Description	Page	Description	Page	Description	Page
Adapter, DB-25 to Dual RJ-11	242	Async Null Modem Adapter — Full Handshake	241	Balun, CCTV Passive Pass-Thru	198
Adapter, DB-25 to RJ-11	242	Async Null Modem Adapter — Standard Handshake	241	Balun, Component Video	199
Adapter, DB-25 to RJ-169	242	Async Short Range Modem with Extra Controls	209	Balun, E1/E2 Single port insulation displacement	190
Adapter, DB-25 to Terminal Block	243	Async to Sync Converter	172	Balun, E1/G.703 Ultra High Density Panel	195
Adapter, DB-9 to DB-25	244	Async to Sync Converter, High Speed	172	Balun, G.703 (E1, E2, E3) Balun— 2 Mbps,	192
Adapter, DB-9 to RJ-11	242	Async to Sync Converter, High Speed RS-232	170	Balun, G.703 (E1, E2, E3) Balun— 34 Mbps,	192
Adapter, DB-9 to RJ-169	242	Async to Sync Converter, RS-232	170	Balun, G.703 (E1) Balun, 2 Mbps (1.6/5.6 Connectors)	193
Adapter, HD-15 to RJ-11	242	Async-over-IP 4-Port Device Server	153	Balun, G.703 Balun(E1), 2 Mbps, with Built-In Cables	192
Adapter, HD-15 to RJ-169	242	Async-over-IP 8-Port Device Server	153	Balun, G.703, 2 Mbps	192
Adapter, Surge Protected, DB-25 to RJ-11	230	Asynchronous 4-Port RS-232 Device Server	152	Balun, G.703, 34 Mbps	192
Adapter, Surge Protected, DB-25 to RJ-169	230	Asynchronous 8-Port RS-232 Device Server	152	Balun, G.703, 8 Mbps	192
Adapter, Surge Protected, DB-9 to RJ-11	230	Asynchronous RS-232 Optical Isolators	237	Balun, IBM 3270 Coax (BNC)	188
Adapter, Surge Protected, DB-9 to RJ-169	230	Asynchronous, Managed	219	Balun, IBM 3270 Coax to Twisted Pair Balun	197
Adapter, Surge Protected, RJ-11 to RJ-11	230	ATM Balun, 75 ohm to 244 ohm	193	Balun, IBM 3X/400 Twinax	188
Adapter, Surge Protected, RJ-12 to RJ-12	230	ATM/Frame Relay T1/E1 Router	52	Balun, Single Port 1.0/2.3 Female Panel Mount to Insulation Displacement Krone	190
Adapter, Surge Protected, RJ-169 to RJ-169	230	AUI Surge Protector	230	Balun, Single Port 1.0/2.3 Male Panel Mount to Insulation Displacement Krone	190
ADSL	68	Auto-Rate Adaptation	60	Balun, Single Port 1.6/5.6 Female Panel Mount to Insulation Displacement Krone	190
ADSL Router	76	Balun CATV Passive	199	Balun, Single Port 1.6/5.6 Male Panel Mount to Insulation Displacement Krone	190
ADSL2+ Triple-Play Access	76	Balun CCTV Passive	198	Balun, Single Port Type 43 Female Panel Mount to Insulation Displacement Krone	190
Analog Phone 4-Channel Module	31	Balun Chassis (Empty)	192	Balun, Single Port Type 43 Male Panel Mount to Insulation Displacement Krone	190
Analog Telephone Adapter, Micro	16	Balun dual , G.703, 2 Mbps	192	Balun, Twinax to Twisted Pair Adapter	197
Analog Telephone Adapter, Residential	17	Balun dual Module, G.703	192	Baseband Modem	95
Analog Telephone Adapter, WiFi	18	Balun dual, G.703, 34 Mbps	192	Baseband Modem, 2-Wire/4-Wire	95
Analog VoIP Router	20	Balun dual, G.703, 8 Mbps	192	Baseband Modem, 2B1Q	95
Analog VoIP SoHo Router	20	Balun E1/E2 Single Port	190	Baseband Rack Card	95
Anti-Streaming Device	215	Balun Module, G.703	192	Basic Point-to-Point Async SRMs — DB-25	203
Arcnet Surge Protector	230	Balun Panel	196	Basic Point-to-Point Async SRMs — DB-9	203
AS/400 Surge Protector (Twinax)	230	Balun Rack, G.703, 16 Port	192		
AS/400 Twinax Balun	188	Balun, 75 ohm to 100 ohm, 155 Mbps (ATM)	193		
Async DB-25 Low Capacitance Surge Protector	232	Balun, CATV Passive	199		
Async DB-25 Surge Protector	232	Balun, CCTV Modular	198		
Async Modem Eliminator, DB-25	241				

Description	Page	Description	Page	Description	Page
Bluetooth IP Access Point	155	CCTV Balun	198	Contents	6
Breakout Box, Micro, DB-25	242	CCTV BNC Video Surge Protector	236	Control Port	102
Breakout Box, Pocket, DB-25	242	CCTV Modular Balun	198	Converter Cable, RS-232 to V.35	174
Breakout Box, RS-232, Economy	242	CCTV Passive Pass-Thru Balun	198	Converter Rack Card	178
Breakout Box, RS-232, Non-Powered	242	CCTV Video Surge Protector	230	Converter—DB-25, 115.2 kbps	185
BRI ISDN 8-Channel Module	31	Centronics 36-Pin Parallel Surge Protector	233	Converter—DB-25, 162.4 kbps	185
BRI Multi-Call VoIP Router	27	Centronics® Port Distance Extender	187	Converter—DB-9, 115.2 kbps	185
Bridge, Ethernet	184	Centronics® Surge Protector	230	Converter—DB-9, 162.4 kbps	185
Bridge, Ethernet EIA-530	184	Channel Bank VoIP FXS/FXO Gateway Router	29	Converter, EIA-574 to RS-232	178
Bridge, Ethernet Extender 12.5 Mbps	59	Channel NTU Bridge	63	Converter, G.703	162
Bridge, Ethernet Extender 144 kbps	61	Channelized Gigabit Router	53	Converter, High Speed Async to Sync	172
Bridge, Ethernet Extender 16.67 Mbps	58	Clear Channel G.703 Converter	164	Converter, IEEE-1284 to RS-232/423	186
Bridge, Ethernet Extender 2.3 Mbps	60	ClusterBox, 2U, 2 Slot	226	Converter, Parallel to Serial	185
Bridge, Ethernet Extender 4.6 Mbps	60	ClusterBox, 2U, 4 Slot	226	Converter, Parallel/Serial, 115.2 kbps	185
Bridge, Ethernet V.35	184	ClusterBox, 2U, 8 Slot	226	Converter, RS-232 to 20mA Rack Card	180
Bridge, Ethernet, V.24 Synchronous	184	Co-Directional G.703 Converter	169	Converter, RS-232 to 20mA, Active/Passive	180
Bridge, Ethernet, X.21	184	Co-Directional G.703 Converters	110	Converter, RS-232 to 20mA, Dual DB-25	180
Bridge, L2	184	Coax (BNC) Baluns, IBM 3270	188	Converter, RS-232 to 20mA, Passive	180
Bridge, Network Access	64	Coax Arcnet Surge Protector (BNC)	230	Converter, RS-232 to 60mA, Passive	180
Bridge, T1/FT1	158	Coax Connector	196	Converter, RS-232 to RS-422	178
Bridge, T1/FT1 Rack Card	161	Coax Ethernet Surge Protector, Thick	230	Converter, RS-232 to RS-485	178
Cable Adapter, Solder Type	243	Coax Ethernet Surge Protector, Thin	230	Converter, RS-232 to RS-485, 2-Wire	178
Cable Adapter, Solderless	243	Coax Surge Protector, Video	230	Converter, RS-232 to RS-485, Opto Isolated	178
Cables (75–120 ohm)	192	Coax to Twisted Pair dual balun	192	Converter, RS-232 to TTL	178
Campus Fiber Modem, Async	216	Coax to Twisted Pair E1/E2 Single Port Balun	190	Converter, RS-232 to V.35 Converter	174
Campus Fiber Modem, Sync/Async	216	Compact Ethernet-over-E1 WAN Bridge	63, 104	Converter, RS-232 to V.35 Converter, Rack Card	174
Campus Modem, Single Fiber, RS-232/V.35	216	Compact Interface Serial to Parallel Converter	185	Converter, RS-232 to V.35, Miniature	174
Campus Modem, SLIP/PPP	208	Compact Interface Serial to Parallel Converter	185	Converter, RS-232 to V.36 (RS-422)	175
Carrier Class RAS	114	Component Video Balun	199	Converter, RS-232 to X.21	173
Category-5 Surge Protector	230	Concentrator, iDSL	94	Converter, RS-422/530 to HSSI	177
Category-5 Surge Protector, Multiport Hub	230	Console Server	148	Converter, RS-449 to V.35	173
Category-5 Surge Protector, Rack Mount	230			Converter, RS-530 to V.35	172
CATV Passive Balun	199			Converter, Serial to Parallel	185

Description	Page	Description	Page	Description	Page
Converter, Serial/Parallel, 115.2 kbps, DB-9	185	CSU/DSU, T1/FT1 Rack Card	161	DB-25 Pocket Tester	242
Converter, Serial/Parallel, 115.2 kbps, Powered	185	Cube Tap, DB-25	244	DB-25 to DB-9 Adapter	241
Converter, Serial/Parallel, 162.4 kbps	185	Current Loop Conv., 20mA, Active, Dual DB-25	180	DB-25 to Dual RJ-11 Adapter	241
Converter, Serial/Parallel, 162.4 kbps, DB-9	185	Current Loop Converter, 20mA, Active/Passive	180	DB-25 to RJ-11 Adapter	241
Converter, Serial/Parallel, Compact, 115.2 kbps	185	Current Loop Converter, 20mA, Passive	180	DB-25 to RJ-11/12 Adapter	242
Converter, Serial/Parallel, Compact, 162.4 kbps	185	Current Loop Converter, 60mA, Passive	180	DB-25 to RJ-169 Adapter	242
Converter, Serial/Parallel, DB-25s, 115.2 kbps	185	D-Shell to Modular Adapters	241	DB-25 to Terminal Block Adapter	243
Converter, Serial/Parallel, DB-25s, 162.4 kbps	185	DACS, iDSL	94	DB-57 Connector	205
Converter, Sync to Async	172	DACS, shDSL	74	DB-9 Data Tap	240
Converter, V.35 to G.704 (E1)	176	DACS, T1/E1 Switch	125–133	DB-9 Data Tap, Half Duplex	240
Converter, V.35 to HSSI	177	Data Tap, DB-25	240	DB-9 Gender Changer	244
Converter, V.35 to T1/FT1	176	Data Tap, DB-9	240	DB-9 Half-Duplex Data Tap	240
Converter, V.35/RS-232 to X.21 Converter, Rack Card	173	Data Tap, DB-9, Half Duplex	240	DB-9 Interface-Powered, RS-232 to RS-422 Converter	178
Converter, X.21 to HSSI	177	Data Tap, M/158 (V.35)	240	DB-9 Modem Power Supply Adapter	240
Converter, X.21 to V.35	173	DB-15 Gender Changer	244	DB-9 Modular Adapter	242
Converter, X.21 to V.35 Converter	173	DB-15 Modem Power Supply Adapter	240	DB-9 Pocket Tester	242
Copper Ethernet Extension	56	DB-15 Modular Adapter	242	DB-9 PocketTester	242
Copper Media Converter	170	DB-15 Surge Protector, Ethernet AUI	230	DB-9 to DB-25 Adapter	241
CopperLink-T E1 Extender	63	DB-15 to RJ-11 Adapter	241	DB-9 to DB-25 Female Adapter	244
Cost CSU/DSU	100	DB-15 to RJ-169 Adapter	241	DB-9 to DB-25 Male Adapter	244
Cross Connect Switch	125–133	DB-25 Breakout Box, Micro	242	DB-9 to RJ-11 Adapter	241
Cross Connect, iDSL	94	DB-25 Cube Tap	244	DB-9 to RJ-169 Adapter	241
CSU/DSU Rack Card	134	DB-25 Data Tap	240	DB-9 to RJ-169 Adapter	241
CSU/DSU T1/FT1	158	DB-25 Gender Changer	244	DC Power Supply, Rack Mount	135
CSU/DSU, DDS	162	DB-25 Interface-Powered, RS-232 to RS-422 Converter	178	DDF Balun Panel E1/E2	190
CSU/DSU, DDS, MicroPak	162	DB-25 Loopback Adapter	241	DDF E1/E2 IDC Krone Single Port Balun	190
CSU/DSU, E1	166	DB-25 Micro Breakout Box	243	DDS Surge Protector	230
CSU/DSU, G.703/G.704	162	DB-25 Null Modem Adapter	241	Desktop ClusterBox	226
CSU/DSU, T1/FT1	100	DB-25 Parallel Surge Protector	233	Device Server	148, 153
CSU/DSU, T1/FT1 low-cost	158	DB-25 Pin 2-3 Reverser	241	Device Server 4-Port RS-232	152
		DB-25 Pocket Breakout Box	242	Device Server 4-Port RS-232/422/485	153
				Device Server 8-Port RS-232	152
				Device Server 8-Port RS-232/422/485	153
				Device Server RS-232	149

Description	Page	Description	Page	Description	Page
Device Server RS-232/422/485 to 10/100	150	E1 30-Channel ISDN/PRI Module	31	Ethernet MicroBridge, X.21	65
Device Server, 4-Port RS-232 Asynchronous	152	E1 Access Converter	162	Ethernet Surge Protector, 100Base-T	230
Device Server, 56-Port RS-232 Asynchronous	152	E1 Access Unit	162	Ethernet Surge Protector, AUI	230
Device Server, RS-232, RS-485, RS-422 selectable	150	E1 Cross Connect	125–133	Ethernet Surge Protector, Custom	230
Device Server, Single Port RS-232	149	E1 DACS	125–133	Ethernet Surge Protector, Thick Coax	230
Device Server, Wireless 802.11b	151	E1 Digital Cross Connect	125–133	Ethernet Surge Protector, Thin Coax	230
Device Servers RS-232 to Wireless 802.11b	151	E1 Extender	62	Ethernet to EIA-530 Converter/Bridge	184
Dial-Up Line Surge Protector	230	E1 Patch Panel, Twisted Pair to Coax, 16 Port	192	Ethernet to RS-232 Converter/Terminal Server	148
Dial-Up RAS	116	E1 Router	168	Ethernet to V.148 Converter/Bridge	184
Dial-Up Remote Access Server	112	E1 Surge Protector	230	Ethernet to V.35 Converter/Bridge	148
Dial-Up Remote Access Server (RAS)	112	E1/E2 IDC Single Port Balun	190	Ethernet to V.35 Converter/Bridge with Serial Cable	148
Digital Cross Connect	126	E1/FE1 Nx64 CSU/DSU	167	Ethernet to X.21 Converter/Bridge	184
Digital Cross Connect Switch	125–133	E1/G.704 to V.35 Converter	167	Ethernet Wireless to RS-232 Device Server	151
Digital Domain RAS & FAX Adapter	122	E1/T1 Edge Access Router, Modular	55	Ethernet-over-E1 WAN Bridge	63
Digital Residential Telephone Adapter	19	E1/T1 VoIP Multi-Port IAD	28	Ethernet-over-E1 WAN Bridge Rack Card	63
Digital Sharing Device	223	E1/T1 WAN Low-Cost Access Router	48	Ethernet, Bluetooth	142
Diskless NanoServ – Thin Case	146	EIA-530 DTE Ethernet MicroBridge	64	Ethernet, Industrial	142
Diskless NanoServ – Ultra-Thin Case	146	EIA-530 Ethernet Bridge	184	Ethernet, Wireless 802.11b	142
Distance Extender, Parallel	187	EIA-574 Surge Protector, DB-9	230	Extended Distance Parallel/Serial Converter	187
DMZ Secure Router	47	EIA-574 to RS-422 Converter	178	Extended Temperature Ethernet Extender	144
DSL Concentration	74	Enterprise RAS	112	Extended Temperature RS-232 Serial Modem	144
DSL IAD	68	Ethernet 10Base-T Surge Protector	230	Extended Temperature T1/E1 Network Termination Unit	144
DSL Modem	68	Ethernet 12.5 Mbps	59	Extended Temperature VoIP Gateway	144
DSL Modem, Rack Mount	68	Ethernet AUI Surge Protector—DB-63	236	Extender Rack Card	58
DSL Products	68	Ethernet Bridge QuikConnect Module	68	Extender USB 1.1	202
DSLAM	68	Ethernet Extender Rack Card	134	Extender, 2 port 2-wire Leased-Line Analog over IP	154
DSP Remote Access Server (RAS)	112	Ethernet Extender, Copper	56	Extender, E1 G.703/G.704 with integrated Balun	62
DSU/CSU Rack Card	134	Ethernet Extension	56	Extender, Ethernet 12.5 Mbps	59
DSU/CSU, T1/FT1	100	Ethernet Hub Protector, 10Base-T	230	Extender, Ethernet 144 kbps	61
DSU/CSU, T1/FT1 Rack Card	103	Ethernet Media Converter	170	Extender, Ethernet 174 Mbps	57
Dual 1.6/5.6 Female	194	Ethernet Micro Bridge	184	Extender, Ethernet 184.67 Mbps	58
Dual BNC Female	194	Ethernet MicroBridge, V.24	65		
E1 /FE1 NTU with Ethernet Bridge	63	Ethernet MicroBridge, V.35	65		

Description	Page	Description	Page	Description	Page
Extender, Ethernet 2.3 Mbps with Auto-Rate Adaptation	.60	Full-Duplex RS-232 over 2-wire Twisted Pair or Coax	.204	G.703 Converter 64K	.169
Extender, Ethernet 4.6 Mbps with Auto-Rate Adaptation	.60	Full-Duplex RS-232 over 2-wire Twisted Pair or Coax with Carrier Sense	.204	G.703 Converter Rack Card	.134
Extender, Ethernet 50 Mbps	.144	FXO/FXS Multi-Port VoIP Gateway	.20	G.703 CSU/DSU	.162
Extender, Ethernet Copper	.56	FXO/FXS Multi-Port VoIP Gateway Router	.29	G.703 Dual Balun, 2 Mbps	.192
Extender, RS-232 with modem controls	.202	FXO/FXS Multi-Port VoIP IAD with WAN Access	.26	G.703 Dual Balun, 34 Mbps	.192
Extender, T1/FT1	.63	FXO/FXS Multi-Port VoIP Router	.24	G.703 Dual Balun, 8 Mbps	.192
F-Type Surge Protector (Video)	.230	FXS VoIP 1-Port Gateway Router	.20	G.703 Extender	.63
Fax Adapter, Analog to IP	.16	FXS VoIP 2-Port Gateway Router	.20	G.703 Interface Converter	.164
Fax Machine Surge Protector	.230	FXS/FXO Multi-Port VoIP Gateway	.21	G.703 Network Termination Unit	.162
FAX Server	.122	FXS/FXO Multi-Port VoIP Gateway Router	.29	G.703 QuikConnect Module	.68
Fiber Media Converter	.170	FXS/FXO Multi-Port VoIP IAD with WAN Access	.26	G.703/188-kbps Interface Converter	.169
Fiber Modem Rack Card	.134	FXS/FXO Multi-Port VoIP Router	.24	G.703/64-kbps Interface Converter	.110
Fiber Modem Rack Card, Async	.226	FXS/FXO Multi-Port VoIP IAD with WAN Access	.26	G.703/G.704 IDC Single Port Balun	.190
Fiber Modem Rack Card, Sync/Async	.226	FXS/FXO VoIP IAD with WAN Access	.26	G.703/G.704 Network Termination Unit (NTU)	.104
Fiber Modem, 128K, QuikConnect	.216	G.703 (E1) 1.6/5.6 Balun Panel	.196	G.703/G.704 NTU	.162
Fiber Modem, 256K, QuikConnect	.216	G.703 (E1) Balun, 2 Mbps (1.6/5.6 Connectors)	.193	G.703/G.704 NTU Rack Card	.162
Fiber Modem, Async	.216	G.703 (E1) BNC Balun Panel	.196	G.703/G.704 NTU with Ethernet Bridge	.64
Fiber Modem, Single Fiber, RS-232/V.35	.216	G.703 (E1) High Density 24 Port Balun Panel	.195	G.704 (E1) to V.35 Converter	.162
Fiber Modem, Sync/Async	.216	G.703 1.6/5.6 Balun Panel	.196	G.SHDSL	.70
ForeFront	.70	G.703 Access Converter	.162	G.SHDSL Concentrator	.74
ForeFront Full-Pipe 8-Slot Chassis	.71	G.703 Access Converter, 2 Mbps	.165	G.SHDSL DSLAM	.70
ForeFront G.SHDSL Line Card/Concentrator	.74	G.703 Access Converter, 64K, MicroPak	.169	G.SHDSL FRF.5/FRF.8 over ATM IAD	.88
ForeFront Half-Pipe 4-slot Chassis System	.71	G.703 Access Converter, 64K, QuikConnect	.169	G.SHDSL High-Speed Router	.89
ForeFront Multi-Port DACS	.125	G.703 and G.703/G.704 nx64 NTU	.162	G.SHDSL IAD	.84
ForeFront RAS	.112	G.703 Balun Module	.188	G.SHDSL ipDSLAM	.80
ForeFront Xtreme 17-slot Chassis System	.71	G.703 Balun Panel	.195	G.SHDSL Modem	.84
ForeSight Network Management System	.72	G.703 Balun Rack, 184 Port	.188	G.SHDSL Multiplexer	.68
Fractional E1 CSU/DSU	.162	G.703 Balun Rack, 184 Port	.188	G.SHDSL.bis Business Router	.90
Fractional T1 CSU/DSU	.158	G.703 Balun, 158 Mbps	.188	Gateway Router, Multi-Port FXS/FXO to VoIP	.29
Fractional T1 to V.35 Converter	.161	G.703 Balun, 2 Mbps	.188	Gateway Router, VoIP 1-Port FXS	.20
Frame Relay/ATM T1/E1 Router	.52	G.703 Balun, 56 Mbps	.188	Gateway Router, VoIP 2-Port FXS	.20
		G.703 BNC Balun Panel	.196	Gateway, VoIP Multi-Port	.21

Description	Page	Description	Page	Description	Page
Gender Changer, DB-149	.244	IAD, Multi-Port ISDN to VoIP	.25	ISDN (4) BRI 8-Channel Module	.31
Gender Changer, DB-57	.244	IAD, Multi-Port ISDN to VoIP with WAN Access	.27	ISDN BRI 8-Channel Module	.31
Gender Changer, DB-63	.244	IBM 3270 Baluns, Coax (BNC)	.188	ISDN BRI PSTN Gateway	.23
Gigabit Channelized Router	.53	IBM 3270 Coax to Twisted Pair Balun	.197	ISDN Fax Server	.122
Ground Loop Protector (Optical Isolator)	.230	IBM 3X/400 Surge Protector (Twinax)	.230	ISDN Multi-Port VoIP IAD	.25
HD-63 to Modular Adapter	.242	IBM 3X/400 Twinax Balun	.188	ISDN Multi-Port VoIP IAD with WAN Access	.27
HD-63 to RJ-169 Adapter	.241	IDC Krone Mounting Panel	.190	ISDN RAS	.112
HD-63 to RJ-59 Adapter	.241	IDC to Coax E1/E2 Single Port Balun	.190	ISDN Remote Access Server (RAS)	.112
HDSL	.68	iDSL	.68	ISDN Surge Protector	.230
High Density RAS	.112	iDSL DACS	.94	ISDN VoIP Router Small & Branch Office	.22
High-Speed G.SHDSL Concentrator for IP Traffic	.80	iDSL DACS Provides Quad T1/E1 & 24 iDSL Ports	.94	ISDN/PRI E1 30-Channel Module	.31
High-Speed Multipoint Short Haul Modem	.205	iDSL DSLAM	.94	ISDN/PRI T1 23-Channel Module	.31
High-Speed Multipoint Short Haul Modem Rack Card	.205	iDSL Line Card	.75	Isolator, Optical, RS-232, Async	.237
High-Speed Serial & RS-232 Extender	.97	iDSL Modem	.95	ISP Solutions	.112
High-Speed Short-Range Modem (RS-232 & RS-530)	.209	iDSL Rack	.95	Kits, D-Shell to Modular Adapters	.241
High-Speed Synchronous Modem Eliminator	.214	iDSL Rack Card	.134	LAN Bridge	.184
High-Speed Synchronous Short-Range Modem	.208	IEEE-1284 to RS-232/423 Converter	.186	LAN Bridge	.65
Horizontal 2-Slot Universal Mounting Panel	.228	Industrial Ethernet	.142	LAN Extender 12.5 Mbps	.59
Horizontal 2-Slot Universal Mounting Panel	.138	Industrial Short-Range Modem for Outdoor Use	.213	LAN Extender 144 kbps	.61
HSSI to RS-422/530	.177	Industrial Surge Protector, Custom	.230	LAN Extender 144 kbps	.61
HSSI to V.35 Converter	.177	Insulation Displacement	.190	LAN Extender 16.67 Mbps	.58
HSSI to X.21 Converter	.177	Insulation Displacement Krone	.190	LAN Extender 174 Mbps	.57
Hub Protector, Cat-5/100Base-T	.230	Interface Converter	.178	LAN Extender 184.67 Mbps	.58
Hub Protector, Ethernet 10Base-T	.230	Interface Converter G.703	.162	LAN Extender 2.3 Mbps	.60
Hub Protector, RS-232/422	.230	Interface Converter G.703	.64	LAN Extender 4.6 Mbps	.60
Hub, Ethernet 10Base-T, 57-Port	.230	Interface Converters	.170	LAN Extender 50 Mbps	.144
IAD for DSL	.68	Interface Matcher, Semi-Automatic	.241	LAN Extender 60.5 Mbps	.59
IAD Multi-Port T1/E1 to VoIP	.28	Interface Matcher, Semi-Automatic, with Cable	.241	LAN Extender, outdoors	.144
IAD, iDSL	.95	IP Network Camera Extender	.62	LAN Protector	.234
IAD, Multi-Port FXS/FXO to VoIP with WAN Access	.26	IP-PBX	.35	LAN Protector, Arcnet	.230
		IP-PBX NanoServer	.32	LAN Protector, Cat-5/100Base-T, Multiport	.230
				LAN Protector, Ethernet	.230
				LAN Protector, Multiport Ethernet 10Base-T	.230

Description	Page	Description	Page	Description	Page
LAN Protector, Token Ring (802.5)	230	Line Driver, Multipoint, 115.2k	200	Media Converter Twisted Pair to E1	63
LAN Surge Protector, Cat-5/100Base-T	230	Line Driver, Multipoint, 115.2k, DB-57	200	Media Converter Twisted Pair to Ethernet	
Leased Line Surge Protector	230	Line Driver, Multipoint, XFMR Isolated	200	Media Converter Twisted Pair to Ethernet 144 kbps	185
Limited Distance Multiplexer, 4 Port	222	Line Driver, Parallel	200	Media Converter Twisted Pair to Ethernet 174 Mbps	180
Limited Distance Multiplexer, 56 Port	222	Line Driver, RS-232 with controls	202	Media Converter Twisted Pair to Ethernet 184.67 Mbps	182
Limited Distance Multiplexer, 6 Port	222	Line Driver, RS-232 with controls, High-Speed ...	202	Media Converter Twisted Pair to Ethernet 2.3 Mbps	184
Line Driver Rack Card, 178/64k, Sync/Async ...	200	Line Driver, SLIP/PPP	200	Media Converter Twisted Pair to Ethernet 4.6 Mbps	184
Line Driver Rack Card, Async	200	Line Driver, Sync, Multipoint	200	Media Converter Twisted Pair to Ethernet 50 Mbps	144
Line Driver Rack Card, Async, Multipoint	200	Line Driver, Sync, Powered, Opto Isolated	200	Media Converter Twisted Pair to Ethernet 60.5 Mbps	148
Line Driver Rack Card, Async, Opto Isolated	200	Line Driver, Sync, X.21	200	Media Converter Twisted Pair to T1	63
Line Driver Rack Card, Fiber, Async	200	Line Driver, Synchronous	200	Media Converters	170
Line Driver Rack Card, Fiber, Sync/Async	200	Line Driver, Universal, 180.6 kbps	200	MegaLink-I 2-Mbps G.703 Converter	107
Line Driver Rack Card, Multipoint, XFMR Iso.	200	Line Driver, Universal, 188 kbps	200	Micro Breakout Box, DB-149	242
Line Driver Rack Card, Single Fiber	200	Line Driver, UNIX	200	Micro Modem Splitter	225
Line Driver Rack Card, SLIP/PPP	200	Line Driver, UNIX, DB-57	200	Micro RAS	112
Line Driver Rack Card, Sync, Opto Isolated	200	Line Driver, XFMR Isolated	200	Micro Serial RAS	123
Line Driver Rack Card, Universal	200	Line Driver, XFMR Isolated, DB-57	200	Micro V.35 to G.703/G.704 (E1) Converter	176
Line Driver Rack Card, XFMR Isolated	200	Line Driver, XFMR Isolated, DB-63	200	Micro V.35 to T1 Converter	176
Line Driver, 178/64k, Sync/Async	200	Loopback Adapter	241	Micro-Analog Telephone Adapter	16
Line Driver, 178/64k, Synchronous	200	Loopback Adapter, DB-149	241	MicroLink CSU/DSU	162
Line Driver, 2W/Coax	200	Low-Cost High-Speed G.SHDSL Modem	84	MicroLink-E1 E1/FE1 Nx64 CSU/DSU	109
Line Driver, 2W/Coax, UNIX	200	Low-Cost T1/E1 WAN Access Router	48	MicroPak Access Converter, 2 Mbps G.703	167
Line Driver, Async	200	Low-Speed Time-Division Multiplexer	218	MicroPak Access Converter, 64K G.703	169
Line Driver, Async, DB-57	200	Lowest Cost G.703 Network Termination Unit (NTU)	108	MicroPak CSU/DSU, DDS	104
Line Driver, Async, DB-63	200	Lowest Cost G.703 NTU	166	MicroPak CSU/DSU, E1/FE1	167
Line Driver, Async, Modular	200	M/158 (V.35) Data Tap	240	MicroPak CSU/DSU, T1/FT1	160
Line Driver, Async, Powered, 115.2k	200	M/158 (V.35) Surge Protector	230	MicroPak G.703 Interface Converter	106
Line Driver, Async, Powered, 162.4kbps	200	M/158 Data Tap (V.35)	240	MicroStat 2-port Statistical Multiplexer	218
Line Driver, Async/Sync	200	MAC Layer Bridge	184	Miniature 2-Port Statistical Multiplexer	218
Line Driver, Fiber, Async	200	Managed Multiplexer	219		
Line Driver, Fiber, Sync/Async	200	Matrix Switch Line Card	78		
Line Driver, Mod., Multipoint, XFMR Iso.	200	MDSL	68		
Line Driver, Modular, XFMR Isolated	200	Media Converter E1 Coax to Twisted Pair	192		

Description	Page	Description	Page	Description	Page
Miniature Async RS-232 Fiber Optic Modem	216	Modem, Short Haul, Multipoint, 115.2k	200	Multiplexer, 2-port Statistical High-Speed	218
Miniature Async/Sync RS-232 Fiber Optic Modem	216	Modem, Short Haul, Multipoint, 115.2k, DB-57	200	Multiplexer, Limited Distance, 4/6/56 Port	222
Modem Eliminator Rack Card, V.35	226	Modem, Short Haul, Multipoint, XFMR Isolated	200	Multiplexer, Managed	219
Modem Eliminator Rack Card, X.21	226	Modem, Short Haul, SLIP/PPP	200	Multiplexer, Statistical, 2-Port, 115.2 kbps	218
Modem Eliminator, Async, DB-149	241	Modem, Short Haul, Sync, Multipoint	200	Multiplexer, Statistical, 2-Port, 162.4 kbps	218
Modem Eliminator, Sync, 162.4 kbps	214	Modem, Short Haul, Sync, Powered, Opto Iso.	200	Multipoint RS-232 & RS-422 Surge Protectors	235
Modem Eliminator, Sync, 162.4 kbps, LEDs	214	Modem, Short Haul, Sync, X.21	200	Multipoint Surge Protector, Cat-5/100Base-T	230
Modem Eliminator, Sync, 224 kbps, LEDs	214	Modem, Short Haul, Synchronous	200	Multipoint Surge Protector, RS-232/422	230
Modem Eliminator, Sync, 512 kbps, LEDs	214	Modem, Short Haul, Universal, 180.6 kbps	200	Mux, Inverse Multi-Megabit	54
Modem Eliminator, Sync, V.35, 144 kbps	214	Modem, Short Haul, Universal, 188 kbps	200	N-Type Surge Protector (Thick Coax Ethernet)	230
Modem Eliminator, Sync, X.21, 144 kbps	214	Modem, Short Haul, UNIX	200	NanoServ with 256MB Flash Drive – Thin Case	146
Modem Sharing Device	225	Modem, Short Haul, UNIX, DB-57	200	NanoServ with 40GB Hard Disk – Thin Case	146
Modem Sharing Device, 3-Port	223	Modem, Short haul, XFMR Isolated	200	NEMA 4 Ethernet Extender	144
Modem Sharing Stat Mux, 2-Port	218	Modem, Short Haul, XFMR Isolated, DB-57	200	NEMA 4 RS-232 Serial Modem	144
Modem Splitter, Passive	223	Modem, Short Haul, XFMR Isolated, DB-63	200	NEMA 4 T1/E1 Network Termination Unit (NTU)	144
Modem Surge Protector	230	Modem/Router	91	NEMA 4 VoIP Gateway	144
Modem, DSL	68	Modular Adapter Kits	241	Network Access Bridge	184
Modem, Fiber, Async	216	Modular Adapters, Custom Wired	241	Network Access Unit	156
Modem, Fiber, Sync/Async	216	Modular Adapters, Surge Protected	230	Network Extender 12.5 Mbps	59
Modem, iDSL	95	Modular T1/E1 Edge/Access Router	55	Network Extender 144 kbps	61
Modem, Short Haul, 178/64k Synchronous	200	Modular to D-Shell Adapters	241	Network Extender 16.67 Mbps	58
Modem, Short Haul, 178/64k, Sync/Async	200	Modular to Modular Adapter	241	Network Extender 174 Mbps	57
Modem, Short Haul, 2W/Coax	200	msDSL	68	Network Extender 184.67 Mbps	58
Modem, Short Haul, 2W/Coax, UNIX	200	Multi-Megabit Inverse Mux	54	Network Extender 2.3 Mbps	60
Modem, Short Haul, Async	200	Multi-Port FXS/FXO Gateway Router	29	Network Extender 4.6 Mbps	60
Modem, Short Haul, Async, DB-57	200	Multi-Port FXS/FXO VoIP Gateway	21	Network Extender 50 Mbps	144
Modem, Short Haul, Async, DB-63	200	Multi-Port FXS/FXO VoIP Router	24	Network Extender 60.5 Mbps	59
Modem, Short Haul, Async, Modular	200	Multi-Port ISDN VoIP IAD	25	Network Surge Protector, Twinax	230
Modem, Short Haul, Async, Powered, 115.2k	200	Multi-Port ISDN VoIP IAD – 4 VoIP Call	25	Network Surge Protector, V.35 (M/158)	230
Modem, Short Haul, Async, Powered, 162.4k	200	Multi-Port ISDN VoIP IAD – 8 VoIP Call	25	Network Termination	156
Modem, Short Haul, Async/Sync	200	Multi-Port ISDN VoIP IAD with Integrated		Network Termination Unit	156
Modem, Short Haul, Mod., Multipoint, XFMR	200	Multi-Port T1/E1 VoIP Integrated Access Device	28	NTU E1/T1, outdoors	144
Modem, Short Haul, Modular, XFMR Iso.	200	Multiplexer, 2-port Statistical	218	NTU, G.703/G.704	162

Description	Page	Description	Page	Description	Page
Null Modem Adapter, DB-149, Async	.241	Parallel/Serial Converter, Compact, 115.2 kbps	.187	QuikConnect CSU/DSU	.110
Nx64 CSU/DSU, E1	.162	Parallel/Serial Converter, Compact, 162.4 kbps	.187	QuikConnect Fiber Modem, 128K	.110
Nx64 CSU/DSU, T1	.158	Parallel/Serial Converter, DB-25s, 115.2 kbps	.187	QuikConnect Fiber Modem, 256K	.110
Optical Isolator, RS-232, 4-Lines, 115.2 kbps	.237	Parallel/Serial Converter, DB-25s, 162.4 kbps	.187	QuikConnect Interface Modules	.110
Optical Isolator, RS-232, 4-Lines, 19.2 kbps	.237	Parts, Rack System	.226	QuikConnect Modem, mDSL	.110
Optical Isolator, RS-232, 7-Lines, 19.2 kbps	.237	Passive RS-530 to V.35 Converter	.172	QuikConnect Module, Data+Voice (3-Port)	.110
Optical Isolator, RS-232, 7-Lines, 115.2 kbps	.237	Patch Panel 2RU E1, High Density 16 port	.192	QuikConnect Module, Ethernet Bridge (RJ-45)	.110
Opto-Isolated DB-149 Interface-Powered, RS-232 to	.144	Patch Panel 2RU E1, High Density 16 port	.192	QuikConnect Module, G.703 (RJ-45)	.110
Outdoors Ethernet Extender	.144	Patch Panel E1 Coax to Twisted Pair	.192	QuikConnect Module, RS-232/V.24 (DB-25)	.110
Outdoors RS-232 Line Driver	.144	Patch Panel E1, 16 Port	.192	QuikConnect Module, RS-422/530 (DB-25)	.110
Outdoors T1/E1 Network Termination	.144	PBX, IP NanoServer	.32	QuikConnect Module, V.35 (M/34)	.110
Outdoors T1/E1 Network Termination Unit (NTU)	.144	PBX, VoIP	.35	QuikConnect Module, X.21 (DB-15)	.110
Outdoors VoIP Gateway	.144	PC Surge Protector, Parallel	.230	QuikConnect, Baseband Modem, 2B1Q	.110
Outdoors VoIP Gateway	.144	PC Surge Protector, RS-232	.230	Rack Card	.103
Pair – 100-ohm	.193	PCI RAS	.122	Rack Card ClusterBox	.226
Pair – 120-ohm	.193	Pin 2-3 Reverser	.241	Rack Card Converter, RS-232 to 20mA C.L.	.226
Pair – 150-ohm	.193	Pin 2-3 Reverser, DB-149	.241	Rack Card Converter, RS-232 to RS-422	.226
Panel Mount Surge Protector, Category-5	.230	Pocket Breakout Box, DB-149	.242	Rack Card Converter, RS-232 to RS-485	.226
Panel — 1.6/5.6 Coax Connector	.196	Pocket Tester, DB-149	.242	Rack Card Converter, RS-232 to V.35	.226
Panel — BNC Coax Connector	.196	Pocket Tester, DB-57	.242	Rack Card Converter, RS-232 to X.21	.226
Parallel Distance Extender	.186	Pocket Tester, DB-57	.242	Rack Card Converter, V.35 to X.21	.226
Parallel Short Range Modem	.186	PocketBOB DB-149 Breakout Box	.242	Rack Card CSU/DSU, All-Rate	.226
Parallel Surge Protector, Centronics®	.230	port G.703 (E1) Balun Panel	.195	Rack Card CSU/DSU, All-Rate/Switched-178	.226
Parallel Surge Protector, DB-149	.230	Powered 56-Channel Async/Sync Statistical Multiplexer	.221	Rack Card CSU/DSU, Switched-178	.226
Parallel to Serial Converter	.187	Powered RS-232 Modem Sharing Device	.224	Rack Card Fiber Modem, 128K	.226
Parallel/Serial Converter, 115.2 kbps	.187	Powered Serial to Parallel Printer Converter	.186	Rack Card Fiber Modem, 256K	.226
Parallel/Serial Converter, 115.2 kbps, DB-57	.187	PPP Bridge	.184	Rack Card Fiber Modem, Async	.226
Parallel/Serial Converter, 115.2 kbps, Powered	.187	PRI/ISDN E1 30-Channel Module	.31	Rack Card Fiber Modem, Sync/Async	.226
Parallel/Serial Converter, 162.4 kbps	.187	PRI/ISDN T1 23-Channel Module	.31	Rack Card G.703 Access Converter, 2 Mbps	.226
Parallel/Serial Converter, 162.4 kbps, DB-57	.187	Printer Distance Extender	.187	Rack Card Short Range Modem, Async	.226
		QuikConnect Access Converter, 64K G.703	.110	Rack Card Single Fiber Modem	.226
				Rack Card SRM, 178/64k, Sync/Async	.226
				Rack Card SRM, Async, Multipoint	.226

Description	Page	Description	Page	Description	Page
Rack Card SRM, Async, Opto Isolated	226	RJ-169 to RJ-169 Adapter	241	RS-232 Interface Connector	241
Rack Card SRM, Multipoint, XFMR Isolated	226	RJ-59 (Dual) to DB-149 Adapter	241	RS-232 Interface Matcher	241
Rack Card SRM, SLIP/PPP	226	RJ-59 to DB-149 Adapter	241	RS-232 Interface Matcher, w/ Cable	241
Rack Card SRM, Sync, Opto Isolated	226	RJ-59 to DB-57 Adapter	241	RS-232 Limited Distance Multiplexers	222
Rack Card SRM, Universal	226	RJ-59 to DB-63 Adapter	241	RS-232 Line Driver, outdoors	144
Rack Card SRM, XMFR Isolated	226	RJ-59 to HD-63 Adapter	241	RS-232 Modem Sharing Device	223
Rack Card Sync Modem Eliminator, V.35	226	RJ-59 to RJ-169 Adapter	241	RS-232 Modem Splitter, Passive	225
Rack Card Sync Modem Eliminator, X.21	226	RJ-59 to RJ-59 Adapter	241	RS-232 Optical Isolator, Async	237
Rack Card, SNMP Proxy Agent	226	Router Line Card	77	RS-232 Over Ethernet	148
Rack Card, T1/FT1	161	Router VPN, Managed T1/E1 WAN Router	50	RS-232 QuikConnect Module	68
Rack Card, T1/FT1	103	Router VPN, Managed V.35 WAN Router	51	RS-232 Stat Mux, 2-Port, 115.2 kbps	218
Rack Chassis, 2U, 184 Slot	226	Router VPN, Managed X.21 WAN Router	51	RS-232 Stat Mux, 2-Port, 162.4 kbps	218
Rack Mount iDSL Modem	95	Router, Analog to VoIP	20	RS-232 Surge Protector	230
Rack Mount Power Supplies, AC and DC	226	Router, Channelized Gigabit	53	RS-232 Surge Protector, Custom	230
Rack Mount Surge Protector, Cat-5/100Base-T	230	Router, DMZ Secure	47	RS-232 Sync Modem Eliminators	172
Rack Parts	226	Router, ISDN VoIP Small & Branch Office	22	RS-232 Terminal Server	148
Rack Power Supply Modules	226	Router, Multi-Call BRI to VoIP	27	RS-232 Terminal Server	148
Rack Systems, 3U/6U	226	Router, Remote Access Server (RAS)	112	RS-232 to 10BaseT	149
Remote Access Server (RAS)	112	Router, T1/E1 Edge Access, Modular	55	RS-232 to 20mA Conv, Active, Dual DB-149	180
Remote Access Servers	112	Router, T1/E1 with FR/ATM	52	RS-232 to 20mA Curr. Loop Conv. Rack Card	180
Repeater, 1.544 Mbps SF/ESF	63	Router, VoIP 4-Slot Modular	30	RS-232 to 20mA Current Loop Conv, Passive	180
Repeater, E1/FE1	63	Router, VoIP Multi-Port	24	RS-232 to 20mA Current Loop Conv., Active	180
Repeater, G.703 and G.703/G.704	63	Router, VPN Multi-Port WAN	46	RS-232 to 60mA Current Loop Conv., Passive	180
Repeater, T1/E1	63	RS-232 4-Port Device Server	152	RS-232 to 802.11b Wireless Device Server	151
Repeater, T1/FT1	63	RS-232 8-Port Device Server	152	RS-232 to Current Loop Converter	182
Residential Analog Telephone Adapter	17	RS-232 Asynchronous to Synchronous Converter	172	RS-232 to RS-422 Converter	178
Residential Digital Telephone Adapter	19	RS-232 Bluetooth Wireless Modem 2-Packs	217	RS-232 to RS-422 Converter Rack Card	178
Residential Telephone Adapter	17	RS-232 Breakout Box, Economy	242	RS-232 to RS-485 Converter	178
Residential VoIP Analog WiFi Telephone Adapter	18	RS-232 Breakout Box, Non-Powered	242	RS-232 to RS-485 Converter Rack Card	178
RJ-169 to DB-149 Adapter	241	RS-232 Extender, High-Speed, with modem controls	202	RS-232 to RS-485 Converter, 2-Wire	178
RJ-169 to DB-57 Adapter	241	RS-232 Extender, with modem controls	202		
RJ-169 to HD-63 Adapter	241	RS-232 Hub Protector	230		

Description	Page	Description	Page	Description	Page
RS-232 to RS-485 Converter, Opto Isolated	178	RS-530 to V.35 Converter	172	Server, RAS	112
RS-232 to TTL Converter	178	RS-530 WAN Bridge	184	Server, Remote Access (RAS)	112
RS-232 to V.160 (RS-422) Converter	175	RS485/422/232 8-Port Device Server	153	Sharing Device, Modems, 3-Port	224
RS-232 to V.160 (RS-530/499) Interface Converter	175	SATV Video Surge Protector	230	SHDSL	68
RS-232 to V.35 Converter Cable	174	SATV/VSAT/Direct TV Video Surge Protector	236	SHDSL Aggregator	74
RS-232 to V.35 Converter, Miniature	174	Screw Terminal Surge Protector, Custom	230	SHDSL Concentrator	74
RS-232 to V.35 Converter, Rack Card	174	Self-Powered Line Extender	208	SHDSL DSLAM	74
RS-232 to X.21 Converter	173	Self-Powered Parallel Line Extenders	187	SHDSL ipDSLAM	80
RS-232 to X.21 Converter, Rack Card	173	Self-Powered RS-232 to TTL	178	Short Range Modem Card, Multipt, XFMR Iso.	200
RS-232 to X.21 Interface Converter	175	Self-Powered Synchronous Short-Range Modem	207	Short Range Modem Rack Card	134
RS-232 WAN Bridge	184	Semi-Automatic Interface Matcher	241	Short Range Modem Rack Card, 178/64 kbps	200
RS-232/423 to IEEE-1284 Converter	186	Semi-Automatic Interface Matcher, with Cable	241	Short Range Modem Rack Card, Async	200
RS-232/423 to IEEE-1284 Converter	178	Serial (RS-232) Surge Protector	230	Short Range Modem Rack Card, Async, Opto	200
RS-422 Hub Protector	230	Serial DB-149 Surge Protector (All 149 Leads)	232	Short Range Modem Rack Card, Multipoint	200
RS-422 Limited Distance Multiplexers	222	Serial G.SHDSL Bridge/Router	87	Short Range Modem Rack Card, SLIP/PPP	200
RS-422 Surge Protector, Custom	230	Serial RAS Server	123	Short Range Modem Rack Card, Sync, Opto	200
RS-422 to EIA-574 Converter	178	Serial to Parallel Converter	185	Short Range Modem Rack Card, Universal	200
RS-422 to RS-232 Converter	178	Serial/Parallel Converter, 115.2 kbps	185	Short Range Modem Rack Card, XFMR Iso.	200
RS-422 to RS-232 Converter Rack Card	178	Serial/Parallel Converter, 115.2 kbps, DB-57	185	Short Range Modem, 178/64k, Sync/Async	200
RS-422/485 Optical Isolators	237	Serial/Parallel Converter, 115.2kbps, Powered	185	Short Range Modem, 178/64k, Synchronous	200
RS-422/485 Surge Protector, DB-57	230	Serial/Parallel Converter, 162.4 kbps	185	Short Range Modem, 2W/Coax	200
RS-422/530 QuikConnect Module	68	Serial/Parallel Converter, 162.4 kbps, DB-57	185	Short Range Modem, 2W/Coax, UNIX	200
RS-422/530 to HSSI Converter	177	Serial/Parallel Converter, Compact, 115.2 kbps	185	Short Range Modem, Async	200
RS-449 to V.35 Converter	175	Serial/Parallel Converter, Compact, 162.4 kbps	185	Short Range Modem, Async, DB-57	200
RS-485 Interface Converter	178	Serial/Parallel Converter, DB-25s, 115.2 kbps	185	Short Range Modem, Async, DB-63	200
RS-485 to EIA-574 Converter	178	Serial/Parallel Converter, Compact, 162.4 kbps	185	Short Range Modem, Async, Modular	200
RS-485 to RS-232 Converter	178	Serial/Parallel Converter, DB-25s, 162.4 kbps	185	Short Range Modem, Async, Powered, 115.2 kbps	200
RS-485 to RS-232 Converter Rack Card	178	Serial/Parallel Converter, DB-25s, 162.4 kbps	185	Short Range Modem, Async, Powered, 162.4 kbps	200
RS-485 to RS-232 Converter, 2-Wire	178	Serial/Parallel Converter, DB-25s, 162.4 kbps	185	Short Range Modem, Async/Sync	200
RS-485 to RS-232 Converter, Opto Isolated	178	Serial/Parallel Micro Matrix Switches	185	Short Range Modem, Fiber, Async	200
RS-485/422/232 to 10/100Base-TX	150			Short Range Modem, Fiber, Sync/Async	200

Description	Page	Description	Page	Description	Page
Short Range Modem, Mod., Multipt, XFMR	200	Statistical Multiplexer, 2-Port, 162.4 kbps	218	Surge Protector, Leased Line	230
Short Range Modem, Modular, XFMR Iso.	200	STM-1 Aggregator	70	Surge Protector, Modem	230
Short Range Modem, Multipoint, 115.2k, DB9	200	STM-1 Time Slot Mapper	70	Surge Protector, Multiport Cat-5/100Base-T	230
Short Range Modem, Multipoint, XFMR Iso.	200	Surge Protected Adapter, DB-149 to RJ-169	230	Surge Protector, Multiport RS-232/RS-422	230
Short Range Modem, Mutipoint, 115.2k	200	Surge Protected Adapter, DB-149 to RJ-59	230	Surge Protector, Parallel, DB-149	230
Short Range Modem, Parallel	200	Surge Protected Adapter, DB-57 to RJ-169	230	Surge Protector, Rack Mount Cat-5/100Base-T	230
Short Range Modem, SLIP/PPP	200	Surge Protected Adapter, DB-57 to RJ-59	230	Surge Protector, RS-232	230
Short Range Modem, Sync, Multipoint	200	Surge Protected Adapter, RJ-169 to RJ-169	230	Surge Protector, Sync DB-149	230
Short Range Modem, Sync, Powered, Opto.	200	Surge Protected Adapter, RJ-59 to RJ-59	230	Surge Protector, T1 Twisted Pair	230
Short Range Modem, Sync, X.21	200	Surge Protected Adapter, RJ-60 to RJ-60	230	Surge Protector, Terminal Strip	230
Short Range Modem, Synchronous	200	Surge Protector, 100Base-T	230	Surge Protector, Twinax	230
Short Range Modem, Universal, 180.6 kbps	200	Surge Protector, 10Base-T Multiport Hub	230	Surge Protector, Type 1 Token Ring (DB-57)	230
Short Range Modem, Universal, 188 kbps	200	Surge Protector, Arcnet	230	Surge Protector, Type 3 Token Ring (UTP)	230
Short Range Modem, UNIX	200	Surge Protector, Async DB-149	230	Surge Protector, V.35 (M/158)	230
Short Range Modem, UNIX, DB-57	200	Surge Protector, Async DB-149, Low Cap.	230	Surge Protector, Video	230
Short Range Modem, XFMR Isolated	200	Surge Protector, Category-5	230	Surge Protectors, Telco Line	230
Short Range Modem, XFMR Isolated, DB-57	200	Surge Protector, Centronics® Parallel	230	Sync DB-149 Surge Protector	232
Short Range Modem, XFMR Isolated, DB-63	200	Surge Protector, CSU/DSU	230	Sync DB-57 Surge Protector	232
Short Range Multiplexer, 4/6/56 Port	222	Surge Protector, DB-149, All Leads	230	Sync DB-63 Surge Protector	232
Short-Range Modem	206	Surge Protector, DB-63	230	Sync Modem Eliminator Rack Card, V.35	214
Short-Range Modem Rack Card	206	Surge Protector, DDS	230	Sync Modem Eliminator Rack Card, X.21	214
Single Port Balun	190	Surge Protector, Dial-Up Line	230	Sync Modem Eliminator, 162.4 kbps	214
Single Port E1/E2 IDC Krone Baluns	190	Surge Protector, E1	230	Sync Modem Eliminator, 162.4 kbps, LEDs	214
Single Port RS-232 Device Server	149	Surge Protector, EIA-574/RS-232, DB-57	230	Sync Modem Eliminator, 224 kbps, LEDs	214
Single-Port Terminal Server	148	Surge Protector, Ethernet 10Base-T	230	Sync Modem Eliminator, 512 kbps, LEDs	214
SIP Telephones	34	Surge Protector, Ethernet AUI	230	Sync Modem Eliminator, V.35, 144 kbps	214
SLIP/PPP Campus Modem	208	Surge Protector, Ethernet, Thick Coax	230	Sync Modem Eliminator, X.21, 144 kbps	214
SoHo Analog VoIP Router	20	Surge Protector, Ethernet, Thin Coax	230	Sync Serial V.25 WAN Router	49
Solder Type Cable Adapter	243	Surge Protector, ISDN	230	Sync Serial V.35 Managed VPN WAN Router	51
Solderless Cable Adapter	243			Sync Serial X.21 Managed VPN WAN Router	51
Standard Small & Branch Office ISDN VoIP Router	22			Sync Serial X.21 WAN Router	49
Statistical Multiplexer, 2-Port, 115.2 kbps	218			Synchronous Converter	172

Description	Page	Description	Page	Description	Page
Synchronous Modem Eliminator	214	Telephone Adapter, Analog to IP	17	Twisted Pair to Coax Single Port balun	190
Synchronous RS-232 Surge Protector	230	Terminal Block to DB-149 Adapter	241	Twisted Pair Token Ring Protector, 802.5	230
Synchronous/Asynchronous Short-Range Modem	206	Terminal Server	148	Twisted Pair—100-ohm	193
T-Splitter Surge Protector, Ethernet	230	Terminal Sever RS-232	149	Twisted Pair—150-ohm	193
T-Splitter Surge Protector, Twinax	230	Terminal Sever RS-232/422/482	150	Twisted Pair—244-ohm	193
T1 23-Channel ISDN/PRI Module	31	Terminal Strip Protector	230	Universal Access	134
T1 Access Unit	158	Terminal Strip Surge Protectors	239	Universal Device Server	150
T1 and E1 Router	168	Termination Unit	144	Universal Short Range Modem	212
T1 Extender	62	Thick Coax Ethernet Surge Protector	230	USB 1.1 Extender Kit	202
T1 Router	168	Thick Ethernet Surge Protector	235	V.148 Synchronous Ethernet MicroBridge	184
T1 Surge Protector, DB-63	230	Thin Coax Ethernet Surge Protector	230	V.148 WAN Bridge	184
T1 Surge Protector, Twisted Pair	230	Thin Ethernet Surge Protector	235	V.160 (RS-422) to RS-232 Converter	175
T1/E1 Cross Connect	125–133	Thin Server / Client / Diskless	146	V.24 QuikConnect Module	68
T1/E1 Cross Connect in 2U High Chassis	126	Thin Server / Client Diskless with 256MB Flash Drive	146	V.24 WAN Bridge	64
T1/E1 Cross Connect in 4U High Chassis	126	Thin Server / Client with integrated Hard Disk	146	V.35 (M/148) Surge Protector	237
T1/E1 DACS	125–133	Think Server / Client / Diskless	146	V.35 Access Converter, 2 Mbps G.703	176
T1/E1 Edge/Access Router, Modular	55	Time Division Multiplexer, Limited Distance	218	V.35 Data Tap (M/158)	240
T1/E1 Managed DACS	130	Token Ring Media Filter, 4/184 Mbps	197	V.35 DTE Ethernet MicroBridge— No Serial Cable	65
T1/E1 Managed VPN WAN Router	50	Token Ring Surge Protector, Custom	230	V.35 Ethernet Bridge	184
T1/E1 Router with FR/ATM	168	Token Ring Surge Protector, Type 1 (DB-57)	230	V.35 Managed VPN WAN Router	51
T1/E1 to VoIP	28	Token Ring Surge Protector, Type 3 (UTP)	230	V.35 QuikConnect Module	68
T1/E1 WAN Low-Cost Access Router	48	Transformer Isolated SRMs Guard Against Ground Loops	203	V.35 Surge Protector (M/158)	230
T1/FT1 CSU/DSU	158	Transition Module	114	V.35 Sync Modem Eliminator Rack Card	226
T1/FT1 CSU/DSU Miniature	160	Transmission Products	148	V.35 Synchronous Modem Eliminator	215
T1/FT1 CSU/DSU Rack Card	161	Transparent LAN Bridge	184	V.35 to G.704 (E1) Converter	176
T1/FT1 High-Density, Low-Cost CSU/DSU Rack Card	161	TTL to RS-232 Converter	178	V.35 to HSSI Converter	177
T1/FT1 Nx64 CSU/DSU	158	Twinax Surge Protector	230	V.35 to RS-232 Converter Cable	174
T1/FT1 to V.35 Converter	176	Twinax Surge Protector for IBM AS/400	236	V.35 to RS-232 Converter, Miniature	174
Table of Contents	6	Twinax to Twisted Pair Adapter (Balun)	188	V.35 to RS-232 Converter, Rack Card	226
Telco Data Tap for T1, E1, or DDS—RJ-169	240	Twinax to Twisted Pair Adapter Balun	197	V.35 to RS-449 Converter	173
Telco Data Tap for T1, E1, or DDS—RJ-59	240	Twisted Pair Ethernet Surge Protector 58 Mbps	230	V.35 to RS-530 Converter	172
Telco Line Surge Protectors	238			V.35 to T1/FT1 Converter	176
				V.35 to X.21 Converter, Rack Card	226

Description	Page	Description	Page	Description	Page
V.35 WAN Access Router	49	VoIP IP-PBX	35	X.21 Sync Modem Eliminator, 144 kbps	215
V.35 WAN Bridge	184	VoIP Micro-Analog Telephone Adapter	16	X.21 Synchronous Modem Eliminator	215
V.35/RS-232 to X.21 Converter, Rack Card	173	VoIP Multi-Port Gateway	21	X.21 to HSSI Converter	177
V.90 RAS	112	VoIP Multi-Port ISDN IAD	25	X.21 to RS-232 Converter	173
V.90 Remote Access Server (RAS)	123	VoIP Multi-Port ISDN IAD with WAN Access	27	X.21 to RS-232 Converter, Rack Card	226
V.92 RAS	112	VoIP Multi-Port Router	24	X.21 to V.35 Converter	173
Variable Rate VDSL Modem	92	VoIP Residential Analog Telephone Adapter	17	X.21 to V.35 Converter, Rack Card	226
Variable Rate VDSL Rack Card	92	VoIP Router	22	X.21 to V.35 Interface Converter	173
VDSL	68	VoIP SIP Telephone	34	X.21 WAN Access Router	49
VDSL Access Concentrator	82	VoIP Small & Branch Office Router	22	X.21 WAN Bridge	184
VDSL Access Concentrator/Switch	82	VoIP SoHo Analog Router	20	Y-Connectors (Data Taps)	240
VDSL Modem	92	VoIP User Packages	38		
VDSL Modem, Variable Rate	92	VPN Managed T1/E1 WAN Router	50		
Vertical 10-Slot Universal Mounting Panel	138	VPN Managed V.35 WAN Router	51		
Vertical 58-Slot Universal Mounting Panel	228	VPN Managed X.21 WAN Router	51		
Video Surge Protector	230	VPN WAN Multi-Port Managed Router	46		
Voice+Data QuikConnect Module	68	VSAT Video Surge Protector	230		
VoIP 23-Channel T1 ISDN PRI Module	31	WAN Access	27		
VoIP 30-Channel E1 ISDN PRI Module	31	WAN Access Router, E1/T1	48		
VoIP 4-Channel Analog Phone Module	31	WAN Access Router, V.35	49		
VoIP 4-Slot Modular Router	30	WAN Access Router, X.21	49		
VoIP 8-Channel 4 ISDN BRI Module	31	WAN Surge Protector, V.35 (M/158)	230		
VoIP 8-Channel ISDN BRI Module	31	Wide Area Ethernet	56		
VoIP Analog Router	20	WiFi Analog Telephone Adapter	18		
VoIP Analog WiFi Telephone Adapter	18	Wireless 802.11b Device Server	151		
VoIP Auto-Provisioning System	36	Workstation Surge Protector, Serial	230		
VoIP BRI Multi-Call Router	27	X-Connector (Cube Tap)	244		
VoIP Digital Residential Telephone Adapter	19	X.21 Access Converter, 2 Mbps G.703	165		
VoIP FXS/FXO Gateway Router	29	X.21 Ethernet Bridge	184		
VoIP FXS/FXO IAD with WAN Access	26	X.21 Managed VPN WAN Router	51		
VoIP Gateway Router; 1-Port FXS	20	X.21 QuikConnect Module	68		
VoIP Gateway Router; 2-Port FXS	20	X.21 Short Range Modem	215		
VoIP Gateway, outdoors	144	X.21 Sync Modem Eliminator Rack Card	226		

Copyright Statement

Copyright © 2007, Patton Electronics Co.
All rights reserved.

Trademark Statement

The terms Patton and SmartNode are registered trademarks of Patton Electronics Company. The following terms are trademarks or service marks of Patton Electronics Company:

ForeFront, NetLink, Full-Pipe, Half-Pipe, CopperLink, FibreLink, QuikConnect, ipRocketLink, DiamondLink, KiloModem, Micro-DACS, KiloLight, DigiLink, MiniLink, MicroLink, MicroPak, MegaLink-I, MicroLink-E1, BroadbandLite, DialFire, OpticLink, ClusterBox, ClusterBoxes, TeleMatch, PocketBOB, PockeTester.

Other referenced trademarked terms are the property of their respective owners.

Terms and Conditions

All transactions for products in this catalog are subject to the terms and conditions found at www.patton.com

Document 07MDCAT21-R1

The Patton Promise

We serve our customers quality products backed by unparalleled support for total customer satisfaction.

1. Free Top-Notch Technical Support

Factory support personnel, who really know the product, will answer your calls immediately on the phone or online. Call **+1.301.975.1007** (USA) or **+41.31.985.25.55** (Switzerland), or e-mail **support@patton.com** today.

2. No Risk 30-Day Money-Back Guarantee

Purchase with complete confidence knowing that **any** Patton product, purchased **anywhere** comes with a 30-day money-back guarantee.

3. Everything Online

We put everything online—user manuals, technical notes, software upgrades, white papers, *everything*.... If it has been published, you can download it anytime from **www.patton.com** and you can order online from any of our E-Commerce partners.

4. The Best Price/Performance

The best price-per-port, the best price-per-mile, the best price-per-megabit... simply the *best*.

5. Certified Channel Support

In the USA and worldwide, Patton has over 200 certified distribution partners to satisfy your unique local needs.

THE BEST

Quality Assurance

An ISO-9001 Certified Company

If you want top-quality products from a top-drawer company, call Patton. In our Gaithersburg, Maryland facility we have put in place a quality assurance system certified to the rigors of ISO-9001 and other international standards organizations, thereby ensuring that our products will always be of the highest quality.



Customer Service

- **Our unique direct-call answering system gets your question answered immediately**
- **Fast, courteous, and accurate order processing**

Our customer service agents provide fast and friendly sales coordination and account management services. They make sure your orders are processed quickly and accurately and shipped promptly.

SUPPORT **EVER**



Technical Assistance

- **FREE top-notch tech support**
- **FREE technical advice & installation assistance**
- **Extended warranty, training, & on-site services**

Our telephone and online (support@patton.com) technical support is unparalleled in the industry. You'll be talking to factory support personnel who quickly answer your calls and questions. Advanced SLAs, Extended Warranty, Advance Replacements, on-site training, installation, and other services are also available.



Logistics

- **Fast shipment via UPS, Fed-Ex, DHL and other common carriers serving the world**
- **Inexpensive air and sea bulk-shipping, consolidation & customs clearance services**

Whether you are just around the corner or half-way around the world, Patton logistics support will get you the products you need when you need them. From pre-staged and tested networks to individual units, we can ship from available inventories around the world—direct or from one of our numerous stocking partners covering the globe.





Corporate Headquarters
 Patton Electronics Company
 7622 Rickenbacker Drive
 Gaithersburg, Maryland, 20879 USA
 tel: +1 301 975 1000 • fax: +1 301 869 9293
 web: www.patton.com
 e-mail: sales@patton.com



EMEA Headquarters
 Patton-Inalp Networks AG
 Meriedweg 7
 CH-3172 Niederwängen, Switzerland
 tel: +41 31 985 25 25 • fax: +41 31 985 25 26
 web: www.patton-inalp.com
 e-mail: europe@patton.com

Regional Contacts

USA & Canada

tel: +1 301 975 1000 • fax: +1 301 869 9293
 e-mail: sales@patton.com

Australia/New Zealand

tel: +61 2 9620 8164 • fax: +1 413 803 6235
 e-mail: australia@patton.com

Western Europe/United Kingdom

tel: +41 31 985 25 25 • fax: 41 31 985 25 26
 e-mail: europe@patton.com

Central Europe/CIS

tel: +1 241 912 1218 • eFax: +1 240 597 8442
 e-mail: ce@patton.com

Middle East and North Africa (MENA)

tel: +961 4 712 691 or 2 • fax: +1 413 832 9194
 e-mail: mena@patton.com

Asia/Pacific

tel: +84 9090 21213 • fax: +1 208 728 1210
 e-mail: asia@patton.com

Latin America/Caribbean

tel: +1 240 912 1219 • fax: +1 301 869 9293
 e-mail: americas@patton.com



w w w . p a t t o n . c o m



7622 Rickenbacker Drive
 Gaithersburg, MD 20879
 301.975.1000

Presorted Standard
 U.S. Postage
PAID
 Rockville, MD
 Permit No. 5130